



Sortimentsliste/*Product Range* 2015



Strongbelt

Antriebstechnik

Metall
Metal



Inhaltsverzeichnis

Contents

Seite
Page

Taperbuchsen <i>Taper bushes</i>	5-6
Ausführungen der Keilrillenscheiben – Auswuchten, Aufschläge für Fertigbohrungen <i>V-grooved pulleys, types – balancing, surcharges for finished bores</i>	7
Keilrillenscheiben für Taperbuchsen – Rillen nach DIN 2211 <i>V-grooved pulleys for taper bushes – grooves to ISO/BS/DIN</i>	8-16
Keilrillenscheiben für zylindrische Bohrung – Rillen nach DIN 2211 <i>V-grooved pulleys for plain boring – grooves to ISO/BS/DIN</i>	17-22
Regelscheiben <i>Variable speed pulleys</i>	23-25
Keilrippenscheiben für Taperbuchsen <i>Ribbed belt pulleys for taper bushes</i>	26-30
Keilrippenscheiben für zylindrische Bohrung <i>Ribbed belt pulleys for plain boring</i>	30
Flachriemenscheiben für Taperbuchsen <i>Flat belt pulleys for taper bushes</i>	31
Motorspannschienen <i>Motor slide rails</i>	32
Motorspannschlitten <i>Motor slide bases</i>	33
Standard-Zahnscheiben für zylindrische Bohrung und Taperbuchsen <i>Timing belt pulleys for plain boring and taper bushes</i>	34-45
HTD®-Zahnscheiben für zylindrische Bohrung und Taperbuchsen <i>HTD® pulleys for plain boring and taper bushes</i>	46-59
Metrische Zahnscheiben für zylindrische Bohrung, T- und AT-Type <i>Metric timing belt pulleys for plain boring, T sections</i>	60-68
Standard-Zahnwellen <i>Timing bars – standard timing belts</i>	67-68
Metrische Zahnwellen <i>Timing bars – metric timing belts</i>	71-72
Einfach-Rollenketten nach DIN 8187-1 (europäische Bauart) <i>Simplex roller chains according to DIN 8187-1 (European type)</i>	73
Zweifach-Rollenketten nach DIN 8187-1 (europäische Bauart) <i>Duplex roller chains according to DIN 8187-1 (European type)</i>	74
Dreifach-Rollenketten nach DIN 8187-1 (europäische Bauart) <i>Triplex roller chains according to DIN 8187-1 (European type)</i>	75
Einfach-Rollenketten nach DIN 8188-1 (amerikanische Bauart) <i>Simplex roller chains according to DIN 8188-1 (American type)</i>	76
Schwere Ausführung mit verstärkten Laschen und vergrößerten Gelenkflächen <i>Heavy duty design with reinforced side plates and enlarged bearing areas</i>	76
Zweifach-Rollenketten nach DIN 8188-1 (amerikanische Bauart) <i>Duplex roller chains according to DIN 8188-1 (American type)</i>	77
Dreifach-Rollenketten nach DIN 8188-1 (amerikanische Bauart) <i>Triplex roller chains according to DIN 8188-1 (American type)</i>	78
Einfach-Rollenketten nach Werksnorm <i>Simplex roller chains (Works-standard)</i>	79
Langgliedrige Rollenketten nach DIN 8181 <i>Double pitch roller chains according to DIN 8181</i>	79
Rollenketten mit geraden Laschen <i>Roller chains with single hole bent attachments</i>	80

Inhaltsverzeichnis

Contents

Seite
Page

Rollenketten nach DIN 8187-1 – Marathon, wartungsfrei <i>Roller chains to DIN 8187-1 – Marathon, maintenance-free</i>	81
Buchsenketten nach DIN 8164 <i>Bush chains according to DIN 8164</i>	82
Hohlbolzenketten <i>Hollow pin chains</i>	82
Einfach- und Mehrfach-Rollenketten aus rost- und säurebeständigem Stahl, Werkstoff 1.4301 <i>Simplex and multiplex roller chains made of stainless and acid resistant steel, W.-no. 1.4301</i>	83
Einfach- und Mehrfach-Rollenketten mit geraden Laschen aus rost- und säurebeständigem Stahl, Werkstoff 1.4301 <i>Simplex and multiplex roller chains made of stainless and acid resistant steel, W.-no. 1.4301 straight plates</i>	84
Verbindungsglieder <i>Connecting links</i>	85
Flyerketten – Reihe LL nach DIN 8152 <i>Leaf chains type series LL according to DIN 8152</i>	86
Flyerketten – schwere Reihe U nach Werksnorm <i>Leaf chains heavy duty design U to works-standard</i>	87
Buchsen-Zahnketten (60°-Flankenwinkel) mit Außenführung <i>Inverted tooth chains with bushings (60° flank angle)</i>	87
Bolzenlöser <i>Chain breaker</i>	88
Montagespanner <i>Chain puller</i>	88
Einfach-Rollenketten nach DIN <i>Simplex roller chains according to DIN</i>	89
Zweifach-Rollenketten nach DIN <i>Duplex roller chains according to DIN</i>	89
Dreifach-Rollenketten nach DIN <i>Triplex roller chains according to DIN</i>	89
Einfach-Rollenketten mit geraden Laschen <i>Simplex roller chains with straight side plates</i>	90
Zweifach-Rollenketten mit geraden Laschen <i>Duplex roller chains with straight side plates</i>	90
Einfach-ASA-Ketten <i>Simplex ASA chains</i>	90
Zweifach-ASA-Ketten <i>Duplex ASA chains</i>	90
ASA-Ketten mit geraden Laschen <i>ASA chains with straight side plates</i>	90
Einfach ASA-Ketten verstärkt <i>Simplex ASA chains, reinforced</i>	91
Zweifach ASA-Ketten verstärkt <i>Duplex ASA chains, reinforced</i>	91
ASA-Ketten verstärkt, mit geraden Laschen <i>ASA chains, reinforced, with straight side plates</i>	91
Rollenketten – Reihe SS „rostfrei“ <i>Roller chains SS series „stainless steel“</i>	91

Inhaltsverzeichnis

Contents

Seite
Page

Rollenketten – Reihe SS, mit geraden Laschen <i>Roller chains SS series with straight side plates</i>	92
Flyerketten – Serie F/LL nach DIN 8152 <i>Leaf chains F/LL series according to DIN 8152</i>	92
Flyerketten – Serie BL/LH nach DIN 8152 <i>Leaf chains BL/LH series according to DIN 8152</i>	93
Vernickelte Witra-Rollenketten nach DIN 8187 <i>Nickel plated roller chains according to DIN 8187</i>	94
Kettenräder <i>Sprockets</i>	95-103
Kettenradscheiben <i>Plate wheels</i>	104-112
Kettenräder für Taperbuchsen <i>Taper bored sprockets</i>	113-118
Taperbuchsen <i>Taper bushes</i>	119
Führungsschienen, Kettenführungen und Riemenführungen <i>Guide rails, chain guides and belt guides</i>	120
Tapernaben <i>Taper hubs</i>	121
Zwischenhülsen <i>Adapters</i>	122
Spannsätze „BK“ <i>Locking Assemblies „BK“</i>	124-138
Klemmplatten für Zahnriemen und Polyurethan-Zahnriemen <i>Clamping plates for Timing Belts and Polyurethane-Timing Belts</i>	139-140

4

Taperbuchsen Taper bushes

Taperbuchsen mit metrischer Bohrung, Nut nach DIN 6885 Teil 1 Taper bushes with metric bores. Keyways to DIN 6885 part 1																	
Taperbuchse Taper bush										Material: EN-GJL 200 – DIN EN 1561							
	1008	1108	1210	1215	1310	1610	1615	2012	2517	3020	3030	3525	3535	4040	4545	5050	
Bohrungs- durch- messer Bore diameter d ₂ (mm)	10	10	11	11	14	14	14	14	16	25	35	35	35	40	55	70	
	11	11	12	12	16	16	16	16	18	28	38	38	38	42	60	75	
	12	12	14	14	18	18	18	18	19	30	40	40	40	45	65	80	
	14	14	16	16	19	19	19	19	20	32	42	42	42	48	70	85	
	15	15	18	18	20	20	20	20	22	35	45	45	45	50	75	90	
	16	16	19	19	22	22	22	22	24	38	48	48	48	55	80	95	
	18	18	20	20	24	24	24	24	25	40	50	50	50	60	85	100	
	19	19	22	22	25	25	25	25	28	42	55	55	55	65	90	105	
	20	20	24	24	28	28	28	28	30	45	60	60	60	70	95	110	
	22	22	25	25	30	30	30	30	32	48	65	65	65	75	100	115	
	24▲	24	28	28	32	32	32	32	35	50	70	70	70	80	105	120	
	25▲	25	30	30	35	35	35	35	38	55	75	75	75	85	110	125	
			28▲	32			38	38	38	40	60		80	80	90		
							40	40	40	42	65		85	85	95		
							42▲	42▲	42	45	70		90	90	100		
								45	48	75							
								48	50								
								50	55								
									60								
Innensechskantschrauben Hexagon socket screws (Zoll inch)	1/4 x 1/2	1/4 x 1/2	3/8 x 5/8	3/8 x 5/8	3/8 x 5/8	3/8 x 5/8	3/8 x 5/8	7/16 x 7/8	1/2 x 1	5/8 x 1 1/4	5/8 x 1 1/4	1/2 x 1 1/2	1/2 x 1 1/2	5/8 x 1 3/4	3/4 x 2	7/8 x 2 1/4	
Anzug Tighten- ing torque (Nm)	5,7	5,7	20	20	20	20	20	31	49	92	92	115	115	172	195	275	
Buchsenlänge Bush length (mm)	22,3	22,3	25,4	38,1	25,4	25,4	38,1	31,8	44,5	50,8	76,2	63,5	88,9	101,6	114,3	127,0	
Gewicht bei Weight at d ₂ min (≈ kg)	0,12	0,16	0,28	0,39	0,32	0,41	0,60	0,75	1,06	2,50	3,75	3,90	5,13	7,68	12,70	15,17	
€ Stück each	auf Anfrage / on request																

Ab 3525: Zylinderkopfschraube mit Innensechskant From 3525: Hexagon head screw

▲ Diese Bohrung ist mit Flachnut ausgeführt. These bores have shallow keyways.

Abmessungen der Keilnuten (UNI 6604 DIN 6885) mit Standardbohrung, metrische Reihe Dimensions of keyways (UNI 6604 DIN 6885) with standard bore, metric series

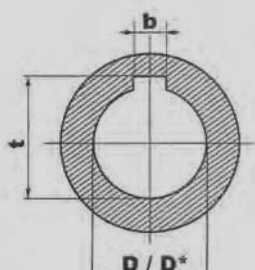
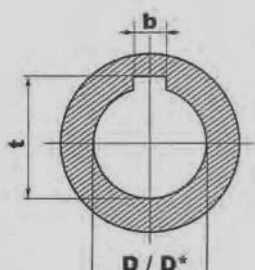
D	b	Js9	t		Abmessungen der Keilnuten Dimensions of keyways		
					D*	b	t
Over 10 to 12	4	± 0,015	D + 1,8		24*	8	D + 1,3
Over 12 to 17	5		D + 2,3				
Over 17 to 22	6		D + 2,8				
Over 22 to 30	8	± 0,018	D + 3,3				
Over 30 to 38	10		D + 3,3				
Over 38 to 44	12		D + 3,3				
Over 44 to 50	14	± 0,021	D + 3,8				
Over 50 to 58	16		D + 4,3				
Over 58 to 65	18		D + 4,4				
Over 65 to 75	20	± 0,026	D + 4,9				
Over 75 to 85	22		D + 5,4				
Over 85 to 95	25		D + 5,4				
Over 95 to 110	28		D + 6,4				
Over 110 to 130	32		± 0,031	D + 7,4			
					65*	18	D + 2,8

Taperbuchsen

Taper bushes

Taperbuchsen mit Zoll-Bohrung, Nut nach Britischem Standard BS 46 Teil 1
Taper bushes with inch bores. Keyways to BS 46 Part 1

	Taperbuchse Taper bush															Material: EN-GJL 200 – DIN EN 1561				
	1008	1108	1210	1215	1310	1610	1615	2012	2517	3020	3030	3525	3535	4040	4545	5050				
Bohrungs- durch- messer Bore diameter d ₂ (Zoll inch)	3/8	3/8	1/2	5/8	1/2	1/2	1/2	5/8	3/4	1 1/4	1 1/4	1 1/2	1 1/2	1 3/4	2 1/4	3				
	1/2	1/2	5/8	3/4	5/8	5/8	5/8	3/4	7/8	1 3/8	1 3/8	1 5/8	1 5/8	1 7/8	2 3/8	3 1/4				
	5/8	5/8	3/4	7/8	3/4	3/4	3/4	7/8	1	1 1/2	1 1/2	1 3/4	1 3/4	2	2 1/2	3 1/2				
	3/4	3/4	7/8	1	7/8	7/8	7/8	1	1 1/8	1 5/8	1 5/8	1 7/8	1 7/8	2 1/8	2 3/4	3 3/4				
	7/8	7/8	1	1 1/8	1	1	1	1 1/8	1 1/4	1 3/4	1 3/4	2	2	2 1/4	2 7/8	4				
	1▲	1	1 1/8	1 1/4	1 1/8	1 1/8	1 1/8	1 1/4	1 3/8	1 7/8	1 7/8	2 1/8	2 1/8	2 3/8	3	4 1/4				
		1 1/8▲	1 1/4		1 1/4	1 1/4	1 1/4	1 3/8	1 1/2	2	2	2 1/4	2 1/4	2 1/2	3 1/4	4 1/2				
					1 3/8	1 3/8	1 3/8	1 1/2	1 5/8	2 1/8	2 1/8	2 3/8	2 3/8	2 5/8	3 3/8	4 3/4				
					1 1/2	1 1/2	1 5/8	1 3/4	2 1/4	2 1/4	2 1/2	2 1/2	2 1/2	2 3/4	3 1/2	5▲				
					1 5/8	1 5/8▲	1 3/4	1 7/8	2 3/8	2 3/8	2 5/8	2 5/8	2 5/8	2 7/8	3 3/4					
								1 7/8	2	2 1/2	2 1/2	2 3/4	2 3/4	3	4					
								2	2 1/8	2 5/8	2 5/8	2 7/8	2 7/8	3 1/8	3 1/8	4 1/4▲				
									2 1/4	2 3/4	2 3/4	3	3	3 1/4	3 1/4	4 1/2▲				
									2 3/8	2 7/8	2 7/8	3 1/8	3 1/8	3 3/8						
									2 1/2	3	3	3 1/4	3 1/4	3 1/2						
											3 3/8	3 3/8	3 3/4▲							
											3 1/2▲	3 1/2▲	4▲							
Innensechskantschrauben Hexagon socket screws (Zoll inch)	1/4 x 1/2	1/4 x 1/2	3/8 x 5/8	3/8 x 5/8	3/8 x 5/8	3/8 x 5/8	3/8 x 5/8	7/16 x 7/8	1/2 x 1	5/8 x 1 1/4	5/8 x 1 1/4	1/2 x 1 1/2	1/2 x 1 1/2	5/8 x 1 3/4	3/4 x 2	7/8 x 2 1/4				
Anzug Tightening torque (Nm)	5,7	5,7	20	20	20	20	20	31	49	92	92	115	115	172	195	275				
Buchsenlänge Bush length (mm)	22,3	22,3	25,4	38,1	25,4	25,4	38,1	31,8	44,5	50,8	76,2	63,5	88,9	101,6	114,3	127,0				
Gewicht bei Weight at d ₂ min (≈ kg)	0,12	0,16	0,28	0,39	0,32	0,41	0,60	0,75	1,06	2,50	3,75	3,90	5,13	7,68	12,70	15,17				
€ Stück each	auf Anfrage / on request																			

Flachnute für Taperbuchsen Shallow keyways for taper bushes

Bohrungsdurchmesser Bore diameter d ₂ (mm)	Nutbreite Keyway width b (mm)	Nuttiefe Keyway depth t ₂ (mm)	Bohrungsdurchmesser Bore diameter d ₂ (mm)	Nutbreite Keyway width b (mm)	Nuttiefe Keyway depth t ₂ (mm)
24	8	2,0	28	8	2,0
25	8	1,3	42	12	2,2

Ab 3525: Zylinderkopfschraube mit Innensechskant From 3525: Hexagon head screw

▲ Diese Bohrung ist mit Flachnut ausgeführt. These bores have shallow keyways.

Ausführungen der Keilrillenscheiben – Auswuchten, Aufschläge für Fertigbohrungen V-grooved pulleys, types – balancing, surcharges for finished bores

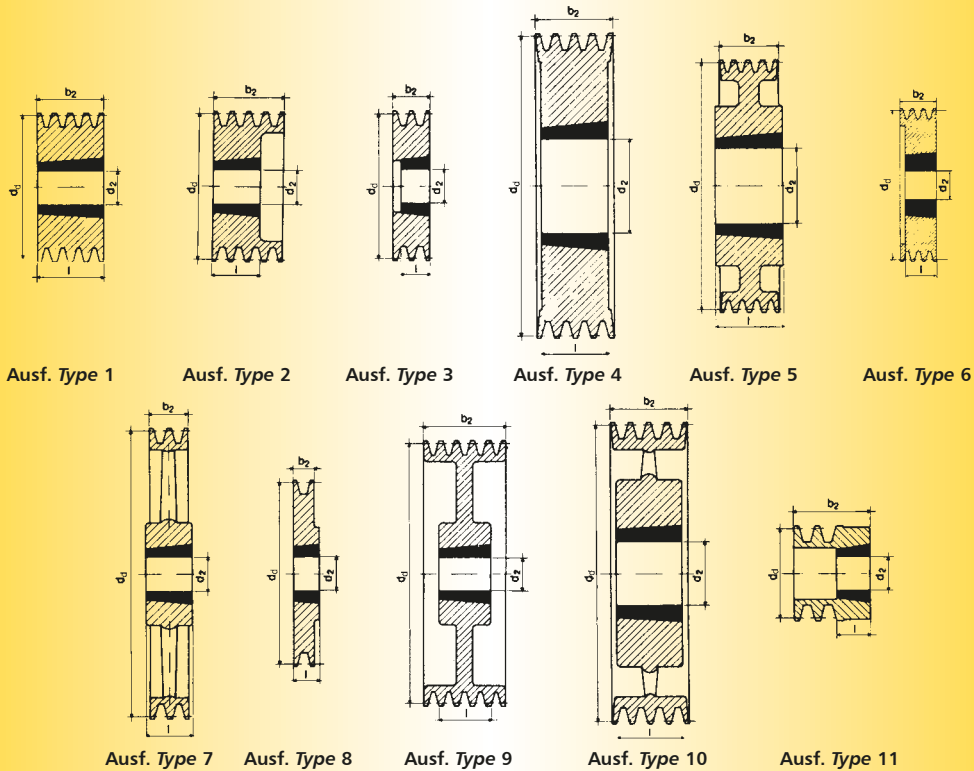

Fertigungstechnische Änderungen der Ausführungen vorbehalten.
We reserve the right to make technical changes.

Auswuchten

Die Listenpreise gelten für in einer Ebene nach DIN/ISO 1940 ausgewuchtete GG-Scheiben wie folgt:
Gütestufe G 6,3 für $\varnothing d_d \leq 400$ mm bei $n = 1500$ min⁻¹, für $\varnothing d_d > 400$ mm bei $v = 30$ m/s.

Die Auswuchtung wird ohne Nut auf glattem Wuchtdorn vorgenommen. Für Maschinen, deren Läufer mit einer in das Wellenende eingesetzten vollen Passfeder ausgewuchtet sind, muss mit folgendem Vermerk bestellt werden: »Ausgewuchtet mit Fertigbohrung und leerer Nut auf glattem Wuchtdorn ohne eingesetzte Passfeder«.

Ein Auswuchten in zwei Ebenen Gütestufe G 6,3 oder feiner ist erforderlich, wenn $v \geq 30$ m/s oder das Verhältnis Richtdurchmesser zu Kranzbreite $d_d : b_2 < 4$ ist bei $v > 20$ m/s.

Mehrpreis auf Anfrage nach Bekanntgabe der Betriebsdrehzahl.

Balancing

The list prices apply, as per VDI 2060, to cast iron pulleys balanced in one plane as follows:

Grade G 6.3 for $d_d \leq 400$ mm at $n = 1500$ rpm, for $d_d > 400$ mm at $v = 30$ m/sec.

Balancing is carried out minus the key on a smooth mandrel. Machines where the rotors are balanced with an adjusting spring inserted in the shaft end must be ordered as follows: "Balanced with finished bore without key on a smooth mandrel without inserted spring".

We recommend balancing in two planes grade G 6.3 or better if $v \geq 30$ m/sec. or if the ratio between datum diameter and pulley face width $d_d : b_2 < 4$ at $v > 20$ m/sec.

Surcharges for balancing on request. Please give pulley operating speed.

Aufschläge für Fertigbohrung H7 und Passfedernut nach DIN 6885 Teil 1 Surcharges for finished bore H7 and keyway to DIN 6885 part 1

Stück Quantity	Fertigbohrung bis 30 mm Finished bore up to 30 mm		Fertigbohrung 31 bis 50 mm Finished bore 31 to 50 mm		Fertigbohrung 51 bis 75 mm Finished bore 51 to 75 mm		Gewindebohrung für Stellschraube Drilled and tapped for setscrews	
	ohne Nut without keyway € Stück each	mit Nut with keyway € Stück each	ohne Nut without keyway € Stück each	mit Nut with keyway € Stück each	ohne Nut without keyway € Stück each	mit Nut with keyway € Stück each		
1 bis to 2	auf Anfrage / on request							€ Stück each
3 bis to 5								
6 bis to 10								
11 bis to 24								
25 bis to 50								
über over 50								

Sonderbearbeitungen und Sonderscheiben auf Anfrage. Special pulleys and custom designed pulleys on request.

Keilrillenscheiben für Taperbuchsen – Rillen nach DIN 2211

V-grooved pulleys for taper bushes – grooves to ISO/BS/DIN



Profil Section SPZ/10

Richt-durchmesser Datum diameter d_d (mm)	Anzahl der Rillen No. of grooves	Ausführung Type		Gewicht ohne Buchse Weight without bush (\approx kg)	Nabe/Hub		Taper-Buchse Taper bush	€ Stück ohne Buchse each without bush	Richt-durchmesser Datum diameter d_d (mm)	Anzahl der Rillen No. of grooves	Ausführung Type		Gewicht ohne Buchse Weight without bush (\approx kg)	Nabe/Hub		Taper-Buchse Taper bush	€ Stück ohne Buchse each without bush	
					Länge length (mm)	Lage zum Kranz ¹⁾ Position to face ¹⁾								Länge length (mm)	Lage zum Kranz ¹⁾ Position to face ¹⁾			
50▲	1	●	11	0,3	37	v 21	1008		106	1	●	8	0,9	25	bü	1610		
	2	●	11	0,4	49	v 21	1008			2	●	6	1,1	25	rü 3	1610		
56▲	1	●	11	0,4	22	rü 15	1008			3	●	6	1,3	25	rü 15	1610		
	2	●	11	0,5	22	rü 27	1108			4	●	6	1,3	25	rü 27	1610		
60	1	●	11	0,2	22	bü	1008			5	●	6	1,5	32	rü 32	2012		
	2	●	11	0,6	22	rü 27	1108			6	●	6	1,6	32	rü 44	2012		
63	1	●	8	0,2	22	bü	1108		112	1	●	8	1,0	25	bü	1610		
	2	●	6	0,3	22	rü 6	1108			2	●	6	1,3	25	rü 3	1610		
	3	●	6	0,4	22	rü 18	1108			3	●	6	1,3	32	rü 8	2012		
67	1	●	8	0,3	22	bü	1108			4	●	6	1,5	32	rü 20	2012		
	2	●	6	0,4	22	rü 6	1108			5	●	6	1,8	32	rü 32	2012		
	3	●	6	0,5	22	rü 18	1108			6	●	6	1,9	32	rü 44	2012		
71	1	●	8	0,3	22	bü	1108		118	1	●	8	0,9	25	bü	1610		
	2	●	6	0,4	22	rü 6	1108			2	●	6	1,3	25	rü 3	1610		
	3	●	6	0,6	22	rü 18	1108			3	●	6	1,6	32	rü 8	2012		
75	1	●	8	0,4	22	bü	1108			4	●	6	1,8	32	bü	2012		
	2	●	6	0,4	25	rü 3	1210			5	●	6	1,8	32	rü 32	2012		
	3	●	6	0,5	25	rü 15	1210			6	●	6	2,0	45	rü 31	2517		
80	1	●	8	0,5	25	bü	1210	auf Anfrage on request	125	1	●	8	1,0	25	bü	1610	auf Anfrage on request	
	2	●	6	0,6	25	rü 3	1210			2	●	6	1,4	25	rü 3	1610		
	3	●	6	0,7	25	rü 15	1210			3	●	2	1,8	32	rü 8	2012		
	4	●	6	0,8	25	rü 27	1210			4	●	2	2,2	32	bü	2012		
85	1	●	8	0,6	25	bü	1210			5	●	6	2,3	32	rü 32	2012		
	2	●	6	0,5	25	rü 3	1610			6	●	6	2,5	45	rü 31	2517		
	3	●	6	0,6	25	rü 15	1610			132	1	●	8	1,1	25	bü		1610
	4	●	6	0,9	25	rü 27	1610				2	●	6	1,5	25	rü 3		1610
	5	●	6	1,0	25	rü 39	1610				3	●	2	2,3	32	rü 8		2012
90	1	●	8	0,7	25	bü	1210			4	●	2	2,5	32	rü 20	2012		
	2	●	6	0,7	25	rü 3	1610			5	●	6	2,7	45	rü 19	2517		
	3	●	6	0,8	25	rü 15	1610			6	●	6	2,9	45	rü 31	2517		
	4	●	6	1,0	25	rü 27	1610			140	1	●	8	1,2	25	bü		1610
	5	●	6	1,2	25	rü 39	1610				2	●	2	1,7	25	rü 3		1610
95	1	●	8	0,7	25	bü	1210			3	●	2	2,6	32	bü	2012		
	2	●	6	0,8	25	rü 3	1610			4	●	2	2,9	32	bü	2012		
	3	●	6	0,9	25	rü 15	1610			5	●	2	3,2	45	bü	2517		
	4	●	6	1,1	25	rü 27	1610			6	●	2	3,5	45	bü	2517		
	5	●	6	1,3	25	rü 39	1610			8	●	4	4,0	45	rü 27,5	2517		
100	1	●	8	0,8	25	bü	1210		150	1	●	8	1,2	25	bü	1610		
	2	●	6	0,9	25	rü 3	1610			2	●	8	2,0	32	bü	2012		
	3	●	6	1,1	25	rü 15	1610			3	●	2	3,1	32	bü	2012		
	4	●	6	1,1	25	rü 27	1610			4	●	2	3,7	45	bü	2517		
	5	●	6	1,3	32	rü 32	2012			5	●	2	4,0	45	bü	2517		
	6	●	6	1,4	32	rü 44	2012			6	●	2	4,4	45	bü	2517		
									8	●	4	5,1	45	rü 27,5	2517			

▲ nur für Profil 10 only for section 10

bü = bündig / precise
rü = Rücksprung / behind
v = Vorsprung / in front

Anzahl der Rillen No. of grooves z	1	2	3	4	5	6	8
Kranzbreite Face width b_2 (mm)	16	28	40	52	64	76	100
Taperbuchse Taper bush	1008	1108	1210	1610	2012	2517	
Bohrung d_2 (mm) von ... bis ... Bore d_2 (mm) from ... to ...	10-25	10-28	11-32	14-42	14-50	16-60	
€/Stück each	auf Anfrage / on request						

- Vollscheibe Solid pulley
- Bodenscheibe Plate pulley (mit oder ohne Spiegel with or without holes)
- × Armscheibe Spoked pulley

¹⁾ Nebenbezugsfläche: Kleiner \varnothing der Kegelbohrung.
Hub reference edge: small diameter of taper bore.

Material: EN-GJL 200 – DIN EN 1561

Bohrungsdurchmesser d_2 siehe Seite 3-4.
Bore diameters d_2 see page 3-4.

Keilrillenscheiben für Taperbuchsen – Rillen nach DIN 2211 V-grooved pulleys for taper bushes – grooves to ISO/BS/DIN



Profil Section SPZ/10

Richt-durch-messer Datum diameter d_d (mm)	Anzahl der Rillen No. of grooves	Ausfüh-rung Type	Gewicht ohne Buchse Weight without bush (\approx kg)	Nabe/Hub		Taper-Buchse Taper bush	€ Stück ohne Buchse each without bush	Richt-durch-messer Datum diameter d_d (mm)	Anzahl der Rillen No. of grooves	Ausfüh-rung Type	Gewicht ohne Buchse Weight without bush (\approx kg)	Nabe/Hub		Taper-Buchse Taper bush	€ Stück ohne Buchse each without bush	
				Länge length (mm)	Lage zum Kranz ¹⁾ Position to face ¹⁾							Länge length (mm)	Lage zum Kranz ¹⁾ Position to face ¹⁾			
160	1	●	8	1,3	25	bü	1610	280	1	×	7	2,9	32	v 8	2012	
	2	●	8	2,5	32	bü	2012		2	×	7	4,0	32	bü	2012	
	3	●	2	3,6	32	bü	2012		3	×	7	5,3	45	bü	2517	
	4	●	2	4,4	45	bü	2517		4	×	10	6,4	45	rü 3,5	2517	
	5	●	2	4,8	45	bü	2517		5	×	10	7,1	45	rü 9,5	2517	
	6	●	2	5,2	45	bü	2517		6	×	10	7,8	45	rü 15,5	2517	
	8	●	4	5,6	45	rü 27,5	2517		8	×	10	10,8	51	rü 24,5	3020	
	170	1	●	8	1,5	25	bü		1610	315	1	×	7	3,1	32	v 8
2		●	8	2,5	32	bü	2012	2	×		7	4,2	32	bü	2012	
3		○	9	4,2	32	bü	2012	3	×		7	6,1	45	bü	2517	
4		●	2	5,3	45	bü	2517	4	×		10	7,6	45	rü 3,5	2517	
5		●	2	5,9	45	bü	2517	5	×		10	8,6	45	rü 9,5	2517	
6		●	2	6,5	45	bü	2517	6	×		10	9,3	45	rü 15,5	2517	
180	1	●	8	1,6	25	bü	1610	355	1	×	7	3,5	32	v 8	2012	
	2	●	8	2,5	32	bü	2012		2	×	7	5,1	32	bü	2012	
	3	○	9	4,8	32	bü	2012		3	×	7	7,3	45	bü	2517	
	4	○	9	6,1	45	bü	2517		4	×	10	8,9	45	rü 3,5	2517	
	5	○	9	6,3	45	bü	2517		5	×	10	10,0	45	rü 9,5	2517	
	6	○	9	6,8	45	bü	2517		6	×	10	10,7	45	rü 15,5	2517	
	8	●	4	7,1	51	rü 24,5	3020		8	×	10	16,0	76	rü 12,0	3030	
	190	1	●	8	1,8	25	bü		1610	400	1	×	7	6,0	32	v 8,5
2		●	8	2,6	32	bü	2012	2	×		7	6,3	45	bü	2517	
3		○	9	4,9	32	bü	2012	3	×		7	8,0	45	bü	2517	
4		○	9	5,3	45	bü	2517	4	×		10	10,1	45	rü 3,5	2517	
5		○	9	6,3	45	bü	2517	5	×		10	11,7	51	rü 6,5	3020	
6		○	9	6,9	45	bü	2517	6	×		10	14,5	76	bü	3020	
200	1	●	8	2,3	32	bü	2012	450	1	×	7	6,1	45	v 14,5	2517	
	2	●	8	2,8	32	bü	2012		2	×	7	8,2	45	v 8,5	2517	
	3	○	9	3,5	32	bü	2012		3	×	7	9,8	45	v 2,5	2517	
	4	○	9	4,7	45	rü 3,5	2517		4	×	10	11,8	51	rü 0,5	3020	
	5	○	9	5,5	45	rü 9,5	2517		5	×	10	13,9	51	rü 6,5	3020	
	6	○	9	6,1	45	rü 15,5	2517		6	×	10	16,9	76	bü	3030	
	8	●	4	9,3	51	rü 24,5	3020		8	×	10	24,0	89	rü 5,5	3535	
	224	1	○	5	2,5	32	bü		2012	500	2	×	7	9,1	45	v 8,5
2		○	5	3,2	32	bü	2012	3	×		7	11,4	45	v 2,5	2517	
3		○	9	3,9	32	rü 4	2012	4	×		10	14,3	51	rü 0,5	3020	
4		○	9	5,2	45	rü 3,5	2517	5	×		10	17,6	76	v 6	3020	
5		○	9	6,0	45	rü 9,5	2517	6	×		10	19,9	76	bü	3020	
6		○	9	6,6	45	rü 15,5	2517	630	3		×	7	15,9	45	v 2,5	2517
8		●	4	11,8	51	rü 24,5	3020		4		×	10	20,0	76	v 12	3020
250		1	×	7	2,8	32	bü	2012	5		×	10	22,7	76	v 6	3020
	2	×	7	3,5	32	bü	2012	6	×	7	33,6	89	v 6,5	3535		
	3	×	10	4,3	32	rü 4	2012									
	4	×	10	5,7	45	rü 3,5	2517									
	5	×	10	6,4	45	rü 9,5	2517									
	6	×	10	7,0	45	rü 15,5	2517									
	8	×	10	10,5	51	rü 24,5	3020									

auf Anfrage on request

auf Anfrage on request

bü = bündig / precise
rü = Rücksprung / behind
v = Vorsprung / in front

Anzahl der Rillen No. of grooves z	1	2	3	4	5	6	8
Kranzbreite Face width b_2 (mm)	16	28	40	52	64	76	100
Taperbuchse Taper bush	1610	2012	2517	3020	3030	3535	
Bohrung d_2 (mm) von ... bis ... Bore d_2 (mm) from ... to ...	14-42	14-50	16-60	25-75	35-75	35-90	
€/Stück each	auf Anfrage / on request						

● Vollscheibe Solid pulley
○ Bodenscheibe Plate pulley (mit oder ohne Spiegel with or without holes)
× Armscheibe Spoked pulley
¹⁾ Nebenbezugs-kante: Kleiner \varnothing der Kegelbohrung.
Hub reference edge: small diameter of taper bore.
Material: EN-GJL 200 – DIN EN 1561
Bohrungsdurchmesser d_2 siehe Seite 3-4.
Bore diameters d_2 see page 3-4.

Keilrillenscheiben für Taperbuchsen – Rillen nach DIN 2211

V-grooved pulleys for taper bushes – grooves to ISO/BS/DIN



Profil Section SPA/13

Richt-durchmesser Datum diameter d_d (mm)	Anzahl der Rillen No. of grooves	Ausführung Type		Gewicht ohne Buchse Weight without bush (\approx kg)	Nabe/Hub		Taper-Buchse Taper bush	€ Stück ohne Buchse each without bush	Richt-durchmesser Datum diameter d_d (mm)	Anzahl der Rillen No. of grooves	Ausführung Type		Gewicht ohne Buchse Weight without bush (\approx kg)	Nabe/Hub		Taper-Buchse Taper bush	€ Stück ohne Buchse each without bush
		●	○		Länge length (mm)	Lage zum Kranz ¹⁾ Position to face ¹⁾					Länge length (mm)	Lage zum Kranz ¹⁾ Position to face ¹⁾					
63▲	1	●	11	0,6	40	v 20	1108	auf Anfrage / on request	125	1	●	8	1,4	25	bü	1610	auf Anfrage on request
	2	●	11	0,8	55	v 20	1108			2	●	2	1,7	25	bü	1610	
67▲	1	●	8	0,3	22	bü	1108		3	●	2	2,0	32	bü	2012		
	2	●	6	0,5	22	rü 13	1108		4	●	2	2,5	32	bü	2012		
71▲	1	●	8	0,3	22	bü	1108		5	●	2	2,7	32	bü	2012		
	2	●	6	0,5	22	rü 13	1108		132	1	●	8	1,6	25	bü	1610	
	3	●	6	0,7	22	rü 28	1108			2	●	2	1,8	32	bü	2012	
75▲	1	●	8	0,4	22	bü	1108		3	●	2	2,3	32	bü	2012		
	2	●	6	0,6	25	rü 13	1108		4	●	2	2,6	45	bü	2517		
	3	●	6	0,8	25	rü 28	1108		5	●	2	2,9	45	bü	2517		
80▲	1	●	8	0,5	25	bü	1210		140	1	●	8	1,8	25	bü	1610	
	2	●	6	0,6	25	rü 10	1210			2	●	2	2,0	32	rü 3	2012	
	3	●	6	0,9	25	rü 25	1210		3	●	2	2,8	45	bü	2517		
85	1	●	8	0,6	25	bü	1210		4	●	2	3,1	45	bü	2517		
	2	●	6	0,7	25	rü 10	1210		5	●	2	3,4	45	bü	2517		
	3	●	6	1,0	25	rü 25	1210		150	1	●	8	1,4	25	bü	1610	
90	1	●	8	0,7	25	bü	1210			2	●	2	2,4	32	rü 3	2012	
	2	●	6	0,7	25	rü 10	1610			3	●	2	3,5	45	bü	2517	
	3	●	6	1,0	25	rü 25	1610			4	●	2	3,8	45	bü	2517	
	4	●	6	1,2	38	rü 27	1615			5	●	2	4,2	45	bü	2517	
95	1	●	8	0,8	25	bü	1210	160	1	○	5	1,9	25	bü	1610		
	2	●	6	0,9	25	rü 10	1610		2	●	2	2,9	32	rü 3	2012		
	3	●	6	1,1	25	rü 25	1610		3	●	2	3,9	45	bü	2517		
	4	●	6	1,4	38	rü 27	1615		4	●	2	4,4	45	bü	2517		
100	1	●	8	0,8	25	bü	1610	5	●	2	5,1	45	bü	2517			
	2	●	6	0,9	25	rü 10	1610	170	1	○	5	2,0	25	bü	1610		
	3	●	2	1,2	25	rü 25	1610		2	●	2	3,1	32	bü	2012		
	4	●	2	1,7	38	rü 27	1610		3	●	2	4,6	45	bü	2517		
	106	5	●	6	1,9	38	rü 42		1610	4	●	2	5,5	45	bü	2517	
1		●	8	0,9	25	bü	1610		5	●	2	5,9	45	bü	3020		
112	2	●	6	1,1	25	rü 10	1610	180	1	○	5	2,1	25	bü	1610		
	3	●	2	1,4	25	rü 25	1610		2	○	9	3,4	32	rü 3	2012		
	4	●	6	2,0	32	rü 33	2012		3	●	2	5,1	45	bü	2517		
	118	5	●	6	2,0	32	rü 48		2012	4	●	2	5,9	45	bü	2517	
		1	●	8	1,0	25	bü		1610	5	●	2	6,2	51	bü	3020	
118	2	●	6	1,2	25	rü 10	1610	190	1	○	5	2,3	25	bü	1610		
	3	●	6	1,3	32	rü 18	2012		2	○	9	3,8	32	bü	2012		
	4	●	6	1,9	32	rü 33	2012		3	●	2	5,4	45	bü	2517		
	200	5	●	6	2,1	32	rü 48		2012	4	●	2	6,8	45	bü	2517	
		1	●	8	1,2	25	bü		1610	5	●	2	7,4	52	bü	3020	
200	2	●	6	1,4	25	rü 10	1610	200	1	○	5	2,6	32	bü	2012		
	3	●	2	1,8	32	rü 18	2012		2	○	5	4,1	45	bü	2517		
	4	●	2	2,0	32	rü 33	2012		3	○	9	4,9	45	bü	2517		
	auf Anfrage / on request	5	●	2	2,4	32	rü 48		2012	4	●	2	7,4	51	bü	3020	
		5	●	4	8,4	51	bü		3020	5	●	4	8,4	51	bü	3020	

▲ nur für Profil 13 only for section 13

bü = bündig / precise
rü = Rücksprung / behind
v = Vorsprung / in front

Anzahl der Rillen No. of grooves z	1	2	3	4	5		
Kranzbreite Face width b_2 (mm)	20	35	50	65	80		
Taperbuchse Taper bush	1108	1210	1610	1615	2012	2517	3020
Bohrung d_2 (mm) von ... bis ... Bore d_2 (mm) from ... to ...	10-28	11-32	14-42	14-42	14-50	16-60	25-75
€/Stück each	auf Anfrage / on request						

- Vollscheibe Solid pulley
- Bodenscheibe Plate pulley (mit oder ohne Spiegel with or without holes)
- × Armscheibe Spoked pulley

¹⁾ Nebenbezugsfläche: Kleiner \varnothing der Kegelbohrung.
Hub reference edge: small diameter of taper bore.

Material: EN-GJL 200 – DIN EN 1561

Bohrungsdurchmesser d_2 siehe Seite 3-4.
Bore diameters d_2 see page 3-4.

Keilrillenscheiben für Taperbuchsen – Rillen nach DIN 2211 V-grooved pulleys for taper bushes – grooves to ISO/BS/DIN

Profil Section SPA/13



Richt-durchmesser Datum diameter d_d (mm)	Anzahl der Rillen No. of grooves	Ausführung Type	Gewicht ohne Buchse Weight without bush (\approx kg)	Nabe/Hub		Taper-Buchse Taper bush	€ Stück ohne Buchse each without bush	Richt-durchmesser Datum diameter d_d (mm)	Anzahl der Rillen No. of grooves	Ausführung Type	Gewicht ohne Buchse Weight without bush (\approx kg)	Nabe/Hub		Taper-Buchse Taper bush	€ Stück ohne Buchse each without bush
				Länge length (mm)	Lage zum Kranz ¹⁾ Position to face ¹⁾							Länge length (mm)	Lage zum Kranz ¹⁾ Position to face ¹⁾		
212	1	○	5	2,7	32	bü	auf Anfrage / on request	500	1	×	7	8,0	45	bü	auf Anfrage on request
	2	○	5	4,3	45	bü			2	×	7	11,6	45	bü	
	3	○	9	5,2	45	bü			3	×	7	16,0	51	bü	
	4	●	2	7,3	52	bü			4	×	10	18,2	51	rü 7	
	5	●	2	8,2	52	bü			5	×	7	27,3	89	bü	
224	1	×	7	2,7	32	bü	auf Anfrage / on request	560	1	×	7	11,6	52	bü	auf Anfrage on request
	2	○	5	4,4	45	bü			2	×	7	15,5	52	bü	
	3	○	9	5,5	45	rü 2,5			3	×	7	17,8	51	bü	
	4	●	2	7,4	51	bü			4	×	7	26,7	89	bü	
	5	●	2	8,3	51	bü			5	×	7	30,4	89	bü	
236	1	×	7	2,8	32	bü	auf Anfrage / on request	630	1	×	7	10,1	45	bü	auf Anfrage on request
	2	○	5	4,6	45	bü			2	×	7	16,0	51	bü	
	3	○	9	5,7	45	bü			3	×	7	22,0	51	bü	
	4	●	2	7,8	52	bü			4	×	7	30,8	89	bü	
	5	●	2	8,7	52	bü			5	×	7	33,7	89	bü	
250	1	×	7	2,9	32	bü	auf Anfrage / on request	630	1	×	7	10,1	45	bü	auf Anfrage on request
	2	×	7	4,8	45	bü			2	×	7	16,0	51	bü	
	3	○	9	5,9	45	rü 2,5			3	×	7	22,0	51	bü	
	4	○	9	8,0	51	rü 7			4	×	7	30,8	89	bü	
	5	○	9	9,0	51	rü 14,5			5	×	7	33,7	89	bü	
280	1	×	7	3,3	32	bü	auf Anfrage / on request	630	1	×	7	10,1	45	bü	auf Anfrage on request
	2	×	7	5,4	45	bü			2	×	7	16,0	51	bü	
	3	○	9	6,7	45	rü 2,5			3	×	7	22,0	51	bü	
	4	○	9	8,8	51	rü 7			4	×	7	30,8	89	bü	
	5	○	5	15,5	89	bü			5	×	7	33,7	89	bü	
315	1	×	7	3,6	32	bü	auf Anfrage / on request	630	1	×	7	10,1	45	bü	auf Anfrage on request
	2	×	7	6,0	45	bü			2	×	7	16,0	51	bü	
	3	○	5	8,3	51	bü			3	×	7	22,0	51	bü	
	4	○	9	9,7	51	rü 7			4	×	7	30,8	89	bü	
	5	○	5	17,0	89	bü			5	×	7	33,7	89	bü	
355	1	×	7	4,2	32	bü	auf Anfrage / on request	630	1	×	7	10,1	45	bü	auf Anfrage on request
	2	×	7	6,7	45	bü			2	×	7	16,0	51	bü	
	3	×	7	9,2	51	bü			3	×	7	22,0	51	bü	
	4	×	10	11,0	51	rü 7			4	×	7	30,8	89	bü	
	5	×	7	18,6	89	bü			5	×	7	33,7	89	bü	
400	1	×	7	4,9	32	bü	auf Anfrage / on request	630	1	×	7	10,1	45	bü	auf Anfrage on request
	2	×	7	8,1	45	bü			2	×	7	16,0	51	bü	
	3	×	7	11,0	51	bü			3	×	7	22,0	51	bü	
	4	×	10	12,8	51	rü 7			4	×	7	30,8	89	bü	
	5	×	7	21,0	89	bü			5	×	7	33,7	89	bü	
450	1	×	7	7,0	32	bü	auf Anfrage / on request	630	1	×	7	10,1	45	bü	auf Anfrage on request
	2	×	7	10,3	45	bü			2	×	7	16,0	51	bü	
	3	×	7	14,1	51	bü			3	×	7	22,0	51	bü	
	4	×	10	15,5	51	rü 7			4	×	7	30,8	89	bü	
	5	×	7	24,3	89	bü			5	×	7	33,7	89	bü	

bü = bündig / precise
rü = Rücksprung / behind
v = Vorsprung / in front

Anzahl der Rillen No. of grooves z	1	2	3	4	5
Kranzbreite Face width b_2 (mm)	20	35	50	65	80
Taperbuchse Taper bush	2012	2517	3020	3030	3535
Bohrung d_2 (mm) von ... bis ... Bore d_2 (mm) from ... to ...	14-50	16-60	25-75	35-75	35-90
€/Stück each	auf Anfrage / on request				

- Vollscheibe Solid pulley
- Bodenscheibe Plate pulley (mit oder ohne Spiegel with or without holes)
- ×

¹⁾ Nebenbezugkante: Kleiner \varnothing der Kegelbohrung.
Hub reference edge: small diameter of taper bore.
Material: EN-GJL 200 – DIN EN 1561
Bohrungsdurchmesser d_2 siehe Seite 3-4.
Bore diameters d_2 see page 3-4.

Keilrillenscheiben für Taperbuchsen – Rillen nach DIN 2211

V-grooved pulleys for taper bushes – grooves to ISO/BS/DIN



Profil Section SPB/17

Richt-durchmesser Datum diameter d_d (mm)	Anzahl der Rillen No. of grooves	Ausführung Type		Gewicht ohne Buchse Weight without bush (\approx kg)	Nabe/Hub		Taper-Buchse Taper bush	€ Stück ohne Buchse each without bush	Richt-durchmesser Datum diameter d_d (mm)	Anzahl der Rillen No. of grooves	Ausführung Type		Gewicht ohne Buchse Weight without bush (\approx kg)	Nabe/Hub		Taper-Buchse Taper bush	€ Stück ohne Buchse each without bush
		●	○		Länge length (mm)	Lage zum Kranz ¹⁾ Position to face ¹⁾					Länge length (mm)	Lage zum Kranz ¹⁾ Position to face ¹⁾					
100▲	1	●	1	0,9	25	bü	1610	auf Anfrage / on request	180	1	●	1	4,1	25	bü	1610	auf Anfrage / on request
	2	●	6	1,2	25	rü 19	1610			2	●	8	4,5	45	bü	2517	
	3	●	6	1,7	25	rü 19	1610			3	●	2	5,5	45	rü 18	2517	
112▲	1	●	1	1,1	25	bü	1610		4	●	4	6,9	45	rü 18,5	2517		
	2	●	6	1,5	25	rü 19	1610		5	●	4	7,1	51	rü 25	3020		
	3	●	6	2,0	25	rü 38	1610		6	●	4	7,7	51	rü 34,5	3020		
118▲	1	●	1	1,3	25	bü	1610		8	●	4	9,5	76	rü 41	3020		
	2	●	6	1,7	25	rü 19	1610		190	1	●	8	4,6	32	bü	2012	
	3	●	6	2,3	25	rü 38	1610			2	●	8	5,0	45	bü	2517	
125▲	1	●	1	1,5	25	bü	1610			3	●	2	6,3	45	rü 18	2517	
	2	●	2	1,9	32	rü 12	2012		4	●	4	7,6	45	rü 18,5	2517		
	3	●	2	2,4	32	rü 31	2012		5	●	4	8,1	51	rü 25	3020		
	4	●	4	3,0	32	rü 50	2012		6	●	4	9,2	51	rü 34,5	3020		
	5	●	6	3,5	32	rü 69	2012		8	●	4	11,2	76	rü 41	3030		
132▲	1	●	1	1,8	25	bü	1610		200	1	●	8	5,0	32	bü	2012	
	2	●	2	2,2	32	rü 12	2012			2	●	8	5,4	45	bü	2517	
	3	●	2	2,8	32	rü 31	2012			3	●	2	6,5	45	bü	2517	
	4	●	4	3,4	32	rü 50	2012			4	●	2	8,8	51	bü	3020	
	5	●	4	3,7	32	rü 34,5	2012	5		●	2	9,1	51	bü	3020		
140	1	●	1	2,3	25	bü	1610	6	●	4	10,3	51	rü 34,5	3020			
	2	●	2	2,7	32	bü	2012	8	●	4	13,5	89	rü 34,5	3535			
	3	●	2	3,3	32	bü	2012	212	1	●	8	4,2	32	bü	2012		
	4	●	2	3,7	45	rü 18,5	2517		2	●	8	4,9	45	bü	2517		
	5	●	2	4,5	45	rü 28	2517		3	●	2	6,0	45	bü	2517		
	6	●	4	4,6	45	rü 36	2517		4	●	2	9,8	51	bü	3020		
150	1	●	1	2,7	25	bü	1610		5	●	2	11,0	51	bü	3020		
	2	●	2	3,1	32	bü	2012		6	●	4	14,3	89	rü 15,5	3535		
	3	●	2	3,9	45	bü	2517	8	●	4	16,6	89	rü 34,5	3535			
	4	●	2	4,4	45	rü 18,5	2517	224	1	●	8	4,7	32	bü	2012		
	5	●	4	5,2	45	rü 28	2517		2	●	8	5,3	45	bü	2517		
	6	●	4	5,6	45	rü 36	2517		3	●	2	6,3	45	bü	2517		
160	1	●	1	2,5	25	bü	1610		4	●	2	11,3	51	bü	3020		
	2	●	2	2,9	32	rü 12	2012		5	●	2	12,7	51	bü	3020		
	3	●	2	4,2	45	rü 18	2517		6	●	4	17,0	89	rü 15,5	3535		
	4	●	4	4,9	45	rü 18,5	2517	8	●	4	19,3	89	rü 34,5	3535			
	5	●	4	6,0	45	rü 28	2517	10	●	4	21,8	89	rü 53,5	3535			
	6	●	4	5,4	51	rü 34,5	3020	236	1	●	8	5,0	32	bü	2012		
170	1	●	1	2,9	25	bü	1610		2	●	8	5,5	45	bü	2517		
	2	●	2	3,3	32	rü 12	2012		3	×	10	7,0	45	bü	2517		
	3	●	2	4,9	45	rü 18	2517		4	×	10	14,5	51	bü	3020		
	4	●	4	5,7	45	rü 18,5	2517		5	●	6	16,9	89	bü	3535		
	5	●	4	6,1	51	rü 25	3020		6	●	4	20,0	89	rü 15,5	3535		
	6	●	4	6,5	51	rü 34,5	3020		8	●	4	22,3	89	rü 34,5	3535		
8	●	4	8,0	76	rü 41	3020	10		●	4	25,3	89	rü 53,5	3535			

▲ nur für Profil 17 only for section 17

bü = bündig / precise
rü = Rücksprung / behind
v = Vorsprung / in front

Anzahl der Rillen No. of grooves z	1	2	3	4	5	6	8	10
Kranzbreite Face width b_2 (mm)	25	44	63	82	101	120	158	196
Taperbuchse Taper bush	1610	2012	2517	3020	3030	3535		
Bohrung d_2 (mm) von ... bis ... Bore d_2 (mm) from ... to ...	14-42	14-50	16-60	25-75	35-75	35-90		
€/Stück each	auf Anfrage / on request							

- Vollscheibe Solid pulley
- Bodenscheibe Plate pulley (mit oder ohne Spiegel with or without holes)
- × Armscheibe Spoked pulley

¹⁾ Neben Bezugskante: Kleiner \varnothing der Kegelbohrung.
Hub reference edge: small diameter of taper bore.
Material: EN-GJL 200 – DIN EN 1561
Bohrungsdurchmesser d_2 siehe Seite 3-4.
Bore diameters d_2 see page 3-4.

Keilrillenscheiben für Taperbuchsen – Rillen nach DIN 2211 V-grooved pulleys for taper bushes – grooves to ISO/BS/DIN

Profil Section SPB/17



Richt-durch-messer Datum diameter d _d (mm)	Anzahl der Rillen No. of grooves	Ausfüh-rung Type	Gewicht ohne Buchse Weight without bush (≈ kg)	Nabe/Hub		Taper-Buchse Taper bush	€ Stück ohne Buchse each without bush	Richt-durch-messer Datum diameter d _d (mm)	Anzahl der Rillen No. of grooves	Ausfüh-rung Type	Gewicht ohne Buchse Weight without bush (≈ kg)	Nabe/Hub		Taper-Buchse Taper bush	€ Stück ohne Buchse each without bush		
				Länge length (mm)	Lage zum Kranz ¹⁾ Position to face ¹⁾							Länge length (mm)	Lage zum Kranz ¹⁾ Position to face ¹⁾				
250	1	●	8	5,4	32	bü	2012	355	2	×	7	8,7	51	bü	3020		
	2	×	7	5,5	45	bü	2517		3	×	10	10,8	51	rü 6	3020		
	3	●	2	7,7	51	bü	3020		4	×	7	18,6	89	bü	3535		
	4	●	2	19,6	51	bü	3020		5	×	10	20,8	89	rü 6	3535		
	5	●	4	21,7	89	bü	3535		6	×	9	22,8	89	rü 15,5	3535		
	6	●	4	23,3	89	rü 15,5	3535		8	×	10	27,0	89	rü 34,5	3535		
	8	●	4	27,5	89	rü 34,5	3535		10	×	10	38,0	102	rü 47	4040		
	10	●	4	29,3	89	rü 53,5	3535		375	2	×	7	9,5			3020	
	265	2	●	7	6,2					2517	3	×	10	11,5	89	bü	3020
		3	○	9	8,0					3020	4	×	10	16,5			3525
4		○	9	9,5			3020	6		×	10	25,0			3535		
6		○	9	16,7			3525	8		×	10	28,0			4040		
8		○	9	24,0			3525	400		2	×	7	10,0	51	bü	3020	
280		1	×	7	6,1	32	bü			2012	3	×	7	18,3	89	bü	3535
	2	×	7	6,8	45	bü	2517			4	×	7	20,5	89	bü	3535	
	3	×	10	8,6	51	rü 6	3020			5	×	10	23,4	89	rü 6	3535	
	4	○	9	10,1	51	rü 15,5	3020			6	×	10	25,1	89	rü 15,5	3535	
	5	○	9	17,8	89	rü 6	3535		8	×	10	36,5	102	rü 28	4040		
	6	○	9	19,6	89	rü 15,5	3535		10	×	10	41,0	102	rü 47	4040		
	8	○	9	26,7	89	rü 34,5	3535		425	2	×	7	11,5			3020	
	10	○	9	30,5	89	rü 53,5	3535			3	×	7	18,0			3535	
300	2	×	7	7,3	45	v 0,5	2517		4	×	7	19,5			3535		
	3	×	10	9,2	51	rü 6	3020	6	×	10	25,1			4040			
	4	○	9	14,3	51	rü 15,5	3020	8	×	10	52,5			4545			
	5	○	9	18,2	89	rü 6	3535	450	2	×	7	12,1	51	bü	3020		
	6	○	9	21,9	89	rü 15,5	3535		3	×	7	21,9	89	bü	3535		
	8	○	9	26,2	89	rü 34,5	3535		4	×	7	24,5	89	bü	3535		
315	1	×	7	7,2	32	bü	2012		5	×	10	27,3	89	rü 6	3535		
	2	×	7	7,8	45	bü	2517		6	×	10	35,5	102	rü 9	4040		
	3	×	10	9,6	51	rü 6	3020		8	×	10	40,9	102	rü 28	4040		
	4	○	5	17,1	89	bü	3535	10	×	10	53,5	104	rü 41	4545			
	5	○	9	18,8	89	rü 6	3535	500	2	×	7	13,2	51	bü	3020		
	6	○	9	23,0	89	rü 15,5	3535		3	×	7	23,1	89	bü	3535		
	8	○	9	26,0	89	rü 34,5	3535		4	×	7	26,6	89	bü	3535		
	10	○	9	31,5	89	rü 53,5	3535		5	×	10	29,9	89	rü 6	3535		
335	2	×	7	7,8	45	bü	2517		6	×	10	38,9	102	rü 9	4040		
	3	×	10	10,5	51	rü 6	3020		8	×	10	45,5	102	rü 28	4040		
	4	×	7	18,3	89	v 3,5	3535	10	×	10	61,0	114	rü 41	4545			
	5	×	10	19,5	89	rü 6	3535	560	2	×	7	16,5	51	v 35	3030		
	6	×	10	22,0	89	rü 15,5	3535		3	×	7	25,9	89	bü	3535		
	8	×	10	28,2	89	rü 34,5	3535		4	×	7	29,0	89	bü	3535		
	10	×	10	36,0	102	rü 47	4040		5	×	7	35,3	102	bü	4040		
									6	×	10	43,1	102	rü 9	4040		
									8	×	10	49,0	114	rü 22	4545		
								10	×	10	55,7	114	rü 41	4545			

auf Anfrage / on request

auf Anfrage / on request

bü = bündig / precise
rü = Rücksprung / behind
v = Vorsprung / in front

Anzahl der Rillen No. of grooves z	1	2	3	4	5	6	8	10
Kranzbreite Face width b ₂ (mm)	25	44	63	82	101	120	158	196
Taperbuchse Taper bush	2012	2517	3020	3030	3535	4040	4545	
Bohrung d ₂ (mm) von ... bis ... Bore d ₂ (mm) from ... to ...	14-50	16-60	25-75	35-75	35-90	40-100	55-110	
€/Stück each	auf Anfrage / on request							

● Vollscheibe Solid pulley
○ Bodenscheibe Plate pulley (mit oder ohne Spiegel with or without holes)
× Armscheibe Spoked pulley
¹⁾ Nebenbezugkante: Kleiner ø der Kegelbohrung. Hub reference edge: small diameter of taper bore.
Material: EN-GJL 200 – DIN EN 1561
Bohrungsdurchmesser d₂ siehe Seite 3-4.
Bore diameters d₂ see page 3-4.

Keilrillenscheiben für Taperbuchsen – Rillen nach DIN 2211

V-grooved pulleys for taper bushes – grooves to ISO/BS/DIN



Profil Section SPB/17

Richt-durchmesser Datum diameter d_d (mm)	Anzahl der Rillen No. of grooves	Ausführung Type		Gewicht ohne Buchse Weight without bush (\approx kg)	Nabe/Hub		Taper-Buchse Taper bush	€ Stück ohne Buchse each without bush	Richt-durchmesser Datum diameter d_d (mm)	Anzahl der Rillen No. of grooves	Ausführung Type		Gewicht ohne Buchse Weight without bush (\approx kg)	Nabe/Hub		Taper-Buchse Taper bush	€ Stück ohne Buchse each without bush
					Länge length (mm)	Lage zum Kranz ¹⁾ Position to face ¹⁾								Länge length (mm)	Lage zum Kranz ¹⁾ Position to face ¹⁾		
630	2	×	7	18,5	76	v 16	3020	auf Anfrage / on request	900	3	×	7	46,8			3535	auf Anfrage / on request
	3	×	7	28,9	89	bü	3535			4	×	7	60,0	102	bü	4040	
	4	×	7	33,3	89	bü	3535			5	×	7	74,8	114	bü	4545	
	5	×	7	43,1	102	bü	4040			6	×	10	81,5	114	rü 3	4545	
	6	×	10	49,2	102	rü 9	4040			8	×	10	110,0	114	rü 22	4545	
	8	×	10	62,0	114	rü 22	4545			10	×	10	126,0	127	rü 34,5	5050	
	10	×	10	72,0	114	rü 41	4545			1000	3	×	7	56,5			
710	3	×	7	33,2	89	bü	3535		4		×	7	66,5	102	bü	4040	
	4	×	7	39,1	89	bü	3535		5		×	7	80,5	114	bü	4545	
	5	×	7	50,2	102	bü	4040		6		×	10	90,0	114	rü 3	4545	
	6	×	10	62,3	114	rü 3	4545		8		×	10	132,0	127	rü 15,5	5050	
	8	×	10	71,0	114	rü 22	4545		10		×	10	147,0	127	rü 34,5	5050	
	10	×	10	80,0	114	rü 41	4545		800		3	×	7	36,7	89	bü	
4	×	7	48,8	102	bü	4040	4			×	7	48,8	102	bü	4040		
5	×	7	56,1	102	bü	4040	5	×		7	56,1	102	bü	4040			
6	×	10	71,4	114	rü 3	4545	6	×		10	71,4	114	rü 3	4545			
8	×	10	90,9	114	rü 22	4545	8	×		10	90,9	114	rü 22	4545			
10	×	10	102,0	114	rü 41	4545	10	×		10	102,0	114	rü 41	4545			

bü = bündig / precise
 rü = Rücksprung / behind
 v = Vorsprung / in front

Anzahl der Rillen No. of grooves z	2	3	4	5	6	8	10
Kranzbreite Face width b_2 (mm)	44	63	82	101	120	158	196
Taperbuchse Taper bush	3020	3030	3535	4040	4545	5050	
Bohrung d_2 (mm) von ... bis ... Bore d_2 (mm) from ... to ...	25-75	35-75	35-90	40-100	55-110	70-125	
€/Stück each	auf Anfrage / on request						

- Vollscheibe Solid pulley
- Bodenscheibe Plate pulley (mit oder ohne Spiegel with or without holes)
- × Armscheibe Spoked pulley

¹⁾ Nebenbezugkante: Kleiner \varnothing der Kegelbohrung.
 Hub reference edge: small diameter of taper bore.

Material: EN-GJL 200 – DIN EN 1561
 Bohrungsdurchmesser d_2 siehe Seite 3-4.
 Bore diameters d_2 see page 3-4.

Keilrillenscheiben für Taperbuchsen – Rillen nach DIN 2211 V-grooved pulleys for taper bushes – grooves to ISO/BS/DIN

Profil Section SPC/22



Richt-durchmesser Datum diameter d_d (mm)	Anzahl der Rillen No. of grooves	Ausführung Type		Gewicht ohne Buchse Weight without bush (\approx kg)	Nabe/Hub		Taper-Buchse Taper bush	€ Stück ohne Buchse each without bush	Richt-durchmesser Datum diameter d_d (mm)	Anzahl der Rillen No. of grooves	Ausführung Type		Gewicht ohne Buchse Weight without bush (\approx kg)	Nabe/Hub		Taper-Buchse Taper bush	€ Stück ohne Buchse each without bush	
		●	○		Länge length (mm)	Lage zum Kranz ¹⁾ Position to face ¹⁾					Länge length (mm)	Lage zum Kranz ¹⁾ Position to face ¹⁾						
200▲	3	●	4	9,0	45	rü 20	2517	auf Anfrage / on request	315	3	○	5	21,6	89	v 2	3535	auf Anfrage / on request	
	4	●	4	10,5	51	rü 30	3020			4	○	9	24,6	89	rü 11	3535		
	5	●	4	14,0	89	rü 16	3535			5	○	9	29,0	89	rü 23,5	3535		
	6	●	4	17,0	89	rü 16	3535			6	○	9	31,4	89	rü 36	3535		
212▲	3	●	4	10,0	51	rü 17	3020		8	○	4	50,0	102	rü 55	4040			
	4	●	4	12,5	51	rü 30	3020		10	○	9	58,0	114	rü 75	4545			
	5	●	4	15,0	89	rü 16	3535		335	3	○	5	22,5	89	v 2	3535		
	6	●	4	18,0	89	rü 36,5	3535			4	○	9	26,5	89	rü 11	3535		
224	2	●	4	8,1	51	rü 4,5	3020			5	○	9	30,0	89	rü 23,5	3535		
	3	●	4	11,0	51	rü 17	3020			6	○	9	35,0	89	rü 36	3535		
	4	●	4	14,0	89	rü 11	3535		8	○	9	58,0	102	rü 55	4040			
	5	●	4	16,2	89	rü 23,5	3535		355	3	○	5	22,9	89	v 2	3535		
6	●	4	19,0	89	rü 36	3535	4			○	9	28,3	89	rü 11	3535			
8	●	4	24,9	89	rü 46	3535	5			○	9	32,5	89	rü 23,5	3535			
236	3	●	4	12,0	51	rü 17	3020			6	○	9	36,0	89	rü 36	3535		
	4	●	4	17,2	89	rü 11	3535		8	○	9	67,5	102	rü 55	4040			
	5	●	4	19,1	89	rü 23,5	3535	10	○	9	121,0	114	rü 75	4545				
	6	●	4	20,8	89	rü 36	3535	375	3	○	5	23,8	89	v 2	3535			
8	●	4	25,5	89	rü 46	3535	4		○	9	30,0	89	rü 11	3535				
250	2	●	4	9,8	51	rü 4,5	3020		5	○	9	33,0	89	rü 23,5	3535			
	3	●	4	14,5	51	rü 17	3020		6	○	9	45,5	102	rü 30	4040			
	4	●	4	20,7	89	rü 11	3535	8	○	9	68,0	114	rü 49	4545				
	5	●	4	22,8	89	rü 23,5	3535	400	3	×	7	24,1	89	v 2	3535			
6	●	4	26,0	89	rü 36	3535	4		×	10	28,0	89	rü 11	3535				
8	●	4	29,7	89	rü 62	3535	5		×	10	34,0	89	rü 23,5	3535				
10	●	4	34,0	102	rü 81	4040	6		○	9	48,0	102	rü 30	4040				
265	3	●	8	21,2	89	bü	3535	8	○	9	65,0	114	rü 49	4545				
	4	○	9	24,0	89	rü 11	3535	10	○	9	88,0	127	rü 68	5050				
	5	○	9	26,2	89	rü 23,5	3535	425	3	×	7	26,0	89	v 2	3535			
	6	○	9	29,0	89	rü 36	3535		4	×	10	31,0	89	rü 11	3535			
8	○	9	33,3	89	rü 62	3535	5		○	9	45,0	89	rü 23,5	4040				
280	3	●	8	24,0	89	bü	3535		6	○	9	58,0	102	rü 30	4545			
	4	○	9	29,0	89	rü 11	3535	8	○	9	74,0	114	rü 49	4545				
	5	○	9	31,0	89	rü 23,5	3535	450	3	×	7	28,6	89	v 2	3535			
	6	○	9	33,8	89	rü 36	3535		4	×	10	33,5	89	rü 11	3535			
8	○	9	37,5	89	rü 62	3535	5		×	10	45,0	102	rü 17	4040				
10	○	9	45,0	102	rü 81	4040	6		○	9	61,1	114	rü 24	4545				
300	3	○	5	21,0	89	v 2	3535	8	○	9	78,7	127	rü 43	5050				
	4	○	9	25,0	89	rü 11	3535	10	○	9	101,0	127	rü 65	5050				
	5	○	9	28,5	89	rü 23,5	3535	475	3	×	7	40,0	89	v 2	3535			
	6	○	9	29,0	89	rü 36	3535		4	×	10	47,0	89	rü 11	3535			
8	●	4	46,5	102	rü 55	4040	5		×	10	47,2	102	rü 17	4040				
10	○	9	53,5	114	rü 75	4545	6		○	9	62,8	114	rü 24	4545				

▲ nur für Profil 22W only for section 22

bü = bündig / precise
rü = Rücksprung / behind
v = Vorsprung / in front

Anzahl der Rillen No. of grooves z	2	3	4	5	6	8	10
Kranzbreite Face width b_2 (mm)	59,5	85	110,5	136	161,5	212,5	263,5
Taperbuchse Taper bush	2517	3020	3535	4040	4545	5050	
Bohrung d_2 (mm) von ... bis ... Bore d_2 (mm) from ... to ...	16-60	25-75	35-90	40-100	55-110	70-125	
€/Stück each	auf Anfrage / on request						

- Vollscheibe Solid pulley
- Bodenscheibe Plate pulley (mit oder ohne Spiegel with or without holes)
- × Armscheibe Spoked pulley

¹⁾ Nebenbezugsfläche: Kleiner ϕ der Kegelbohrung.
Hub reference edge: small diameter of taper bore.
Material: EN-GJL 200 – DIN EN 1561
Bohrungsdurchmesser d_2 siehe Seite 3-4.
Bore diameters d_2 see page 3-4.

Keilrillenscheiben für Taperbuchsen – Rillen nach DIN 2211

V-grooved pulleys for taper bushes – grooves to ISO/BS/DIN



Profil Section SPC/22

Richt-durchmesser Datum diameter d_d (mm)	Anzahl der Rillen No. of grooves	Ausführung Type		Gewicht ohne Buchse Weight without bush (\approx kg)	Nabe/Hub		Taper-Buchse Taper bush	€ Stück ohne Buchse each without bush	Richt-durchmesser Datum diameter d_d (mm)	Anzahl der Rillen No. of grooves	Ausführung Type		Gewicht ohne Buchse Weight without bush (\approx kg)	Nabe/Hub		Taper-Buchse Taper bush	€ Stück ohne Buchse each without bush		
					Länge length (mm)	Lage zum Kranz ¹⁾ Position to face ¹⁾								Länge length (mm)	Lage zum Kranz ¹⁾ Position to face ¹⁾				
500	3	×	7	30,9	89	v 2	3535	auf Anfrage / on request	800	3	×	7	72,0			4545	auf Anfrage / on request		
	4	×	10	39,0	89	rü 11	3535			4	×	7	90,8	127	v 8,25	5050			
	5	×	10	48,7	102	rü 17	4040			5	×	10	102,5	127	rü 4,5	5050			
	6	×	10	60,2	115	rü 24	4545			6	×	10	113,7	127	rü 17	5050			
	8	○	9	87,4	127	rü 43	5050			8	×	10	136,6	127	rü 43	5050			
	10	○	9	127,0	127	rü 68	5050			10	○	9	160,7	127	rü 68	5050			
560	3	×	7	36,0			3535		auf Anfrage / on request	1000	5	×	10	134,0	127	rü 4,5		5050	
	4	×	10	50,0	102	rü 4	4040				6	×	10	150,0	127	rü 17		5050	
	5	×	10	63,0	114	rü 11	4545				8	×	10	181,4	127	rü 43		5050	
	6	×	10	77,0	127	rü 17	5050				10	○	9	217,2	127	rü 68		5050	
	8	×	10	94,0	127	rü 43	5050				1250	5	×	10	177,6	127		rü 4,5	5050
	10	○	9	115,0	127	rü 68	5050					6	×	10	201,4	127		rü 17	5050
630	3	×	7	48,5	102	v 8,5	4040			8		×	10	243,7	127	rü 43		5050	
	4	×	7	61,0	119	v 1,5	4545			10		○	9	292,1	127	rü 68		5050	
	5	×	10	77,0	127	rü 4,5	5050			710		3	×	7	62,5				4040
	6	×	10	86,0	127	rü 17	5050					4	×	7	78,6				4545
	8	×	10	105,5	127	rü 43	5050				5	×	10	89,6	127	rü 4,5		5050	
	10	○	9	130,0	127	rü 68	5050				6	×	10	99,4	127	rü 17		5050	
710	3	×	7	62,5			4040	8	×		10	117,5	127	rü 43	5050				
	4	×	7	78,6			4545	10	○		9	137,1	127	rü 68	5050				
	5	×	10	89,6	127	rü 4,5	5050												
	6	×	10	99,4	127	rü 17	5050												
	8	×	10	117,5	127	rü 43	5050												
	10	○	9	137,1	127	rü 68	5050												

bü = bündig / precise
 rü = Rücksprung / behind
 v = Vorsprung / in front

Anzahl der Rillen No. of grooves z	3	4	5	6	8	10
Kranzbreite Face width b_2 (mm)	85	110,5	136	161,5	212,5	263,5
Taperbuchse Taper bush	3535	4040	4545	5050		
Bohrung d_2 (mm) von ... bis ... Bore d_2 (mm) from ... to ...	35-90	40-100	55-110	70-125		
€/Stück each	auf Anfrage / on request					

● Vollscheibe Solid pulley
 ○ Bodenscheibe Plate pulley
 (mit oder ohne Spiegel with or without holes)
 × Armscheibe Spoked pulley
¹⁾ Nebenbezugkante: Kleiner \varnothing der Kegelbohrung.
 Hub reference edge: small diameter of taper bore.
 Material: EN-GJL 200 – DIN EN 1561
 Bohrungsdurchmesser d_2 siehe Seite 3-4.
 Bore diameters d_2 see page 3-4.

Keilrillenscheiben für zylindrische Bohrung – Rillen nach DIN 2211 V-grooved pulleys for plain boring – grooves to ISO/BS/DIN

Profil Section SPZ/10

Richtdurchmesser Datum diameter d_d (mm)	Anzahl der Rillen No. of grooves	Ausführung Type	Gewicht Weight (\approx kg)	Fertigbohrung Finished bore d_{max} (mm)	Nabenlänge Hub length l (mm)	€ Stück zentriert each centered	Richtdurchmesser Datum diameter d_d (mm)	Anzahl der Rillen No. of grooves	Ausführung Type	Gewicht Weight (\approx kg)	Fertigbohrung Finished bore d_{max} (mm)	Nabenlänge Hub length l (mm)	€ Stück zentriert each centered																							
45▲	1	○	0,2	16	24	auf Anfrage on request	140	1	○	0,9	28	24	auf Anfrage on request																							
	2	○	0,3	16	35			2	○	1,4	38	38																								
	3	○	0,4	16	35			3	○	1,7	38	40																								
50▲	1	○	0,3	20	24		150	1	×	1,1	28	24		auf Anfrage on request																						
	2	○	0,4	20	35			2	○	1,5	38	38																								
	3	○	0,5	20	40			3	○	1,9	38	40																								
56▲	1	○	0,3	20	24		160	1	×	1,2	32	30			auf Anfrage on request																					
	2	○	0,5	25	35			2	×	1,6	38	38																								
	3	○	0,7	25	40			3	×	2,4	42	40																								
63	1	○	0,3	25	24		170	1	×	1,7	40	30				auf Anfrage on request																				
	2	○	0,6	25	35			2	×	1,9	40	38																								
	3	○	0,9	25	40			3	×	3,0	42	40																								
71	1	○	0,3	25	24		180	1	×	2,1	32	30					auf Anfrage on request																			
	2	○	0,6	25	35			2	×	3,1	38	38																								
	3	○	1,0	30	40			3	×	3,5	42	40																								
75	1	○	0,4	24	24		190	1	×	2,3	35	30						auf Anfrage on request																		
	2	○	0,6	24	35			2	×	2,4	35	38																								
	3	○	1,1	28	40			3	×	4,0	35	40																								
80	1	○	0,4	25	24		200	1	×	2,4	32	38							auf Anfrage on request																	
	2	○	0,7	30	35			2	×	2,9	38	38																								
	3	○	1,1	38	35			3	×	4,5	42	40																								
85	1	○	0,3	25	24		212	1	×	2,6	35	30								auf Anfrage on request																
	2	○	0,7	30	35			2	×	3,4	35	38																								
	3	○	1,1	38	35			3	×	5,0	38	40																								
90	1	○	0,4	25	24		225	1	×	2,8	32	38									auf Anfrage on request															
	2	○	0,8	30	35			2	×	4,0	38	38																								
	3	○	1,2	38	38			3	×	5,3	42	40																								
95	1	○	0,4	28	24		250	1	×	3,3	32	38										auf Anfrage on request														
	2	○	0,8	28	35			2	×	4,8	38	38																								
	3	○	1,2	38	38			3	×	6,0	42	40																								
100	1	○	0,5	28	24	280	1	×	3,9	35	34	auf Anfrage on request																								
	2	○	0,9	30	35		2	×	5,2	42	38																									
	3	○	1,3	38	38		3	×	7,0	48	40																									
106	1	○	0,5	30	24	315	1	×	4,4	35	34		auf Anfrage on request																							
	2	○	1,0	28	35		2	×	6,8	42	38																									
	3	○	1,3	38	38		3	×	8,3	48	40																									
112	1	○	0,5	28	24	355	1	×	4,6	35	34			auf Anfrage on request																						
	2	○	1,0	30	35		2	×	8,0	42	40																									
	3	○	1,4	38	38		3	×	10,0	48	45																									
118	1	○	0,6	28	24	auf Anfrage on request	auf Anfrage on request	auf Anfrage on request	auf Anfrage on request	auf Anfrage on request	auf Anfrage on request				auf Anfrage on request	auf Anfrage on request																				
	2	○	1,1	38	35																															
	3	○	1,5	38	38																															
125	1	○	0,7	28	24												auf Anfrage on request						auf Anfrage on request	auf Anfrage on request	auf Anfrage on request	auf Anfrage on request	auf Anfrage on request	auf Anfrage on request	auf Anfrage on request							
	2	○	1,2	38	35																															
	3	○	1,6	38	40																															
132	1	○	0,8	30	24													auf Anfrage on request												auf Anfrage on request	auf Anfrage on request	auf Anfrage on request	auf Anfrage on request	auf Anfrage on request	auf Anfrage on request	auf Anfrage on request
	2	○	1,3	38	35																															
	3	○	1,6	40	40																															

▲ nur für Profil 10 only for section 10

Anzahl der Rillen No. of grooves z	1	2	3
Kranzbreite Face width b_2 (mm)	16	28	40

- Vollscheibe Solid pulley
 - Bodenscheibe Plate pulley (mit oder ohne Spiegel with or without holes)
 - × Armscheibe Spoked pulley
- Nabenlage: einseitig bündig
Hub position: one side flush
Material: EN-GJL 200 – DIN EN 1561

Keilrillenscheiben für zylindrische Bohrung – Rillen nach DIN 2211

V-grooved pulleys for plain boring – grooves to ISO/BS/DIN

Profil Section SPA/13

Richtdurchmesser Datum diameter d_d (mm)	Anzahl der Rillen No. of grooves	Ausführung Type	Gewicht Weight (\approx kg)	Fertigbohrung Finished bore d_{max} (mm)	Nabenlänge Hub length l (mm)	€ Stück zentriert each centered	Richtdurchmesser Datum diameter d_d (mm)	Anzahl der Rillen No. of grooves	Ausführung Type	Gewicht Weight (\approx kg)	Fertigbohrung Finished bore d_{max} (mm)	Nabenlänge Hub length l (mm)	€ Stück zentriert each centered
50▲	1	○	0,3	18	34	auf Anfrage on request	106	1	○	0,9	28	34	auf Anfrage on request
	2	○	0,5	18	49			2	○	1,7	28	49	
	3	○	0,6	18	47			3	○	2,2	32	42	
56▲	1	○	0,4	20	34		4▽	○	3,2	32	53		
	2	○	0,6	20	49		5▽	○	3,9	35	60		
	3	○	0,7	20	47		112	1	○	1,1	28	34	
63▲	1	○	0,5	25	34			2	○	1,8	38	49	
	2	○	0,8	25	49			3	○	2,4	38	42	
	3	○	0,9	25	47			4▽	○	3,4	42	53	
	4▽	○	1,2	25	60			5▽	○	4,0	42	60	
71▲	5▽	○	1,5	25	70		118	1	○	1,1	32	34	
	1	○	0,5	25	34			2	○	1,8	38	49	
	2	○	0,9	28	49			3	○	2,4	42	42	
	3	○	1,0	32	42			4▽	○	3,4	42	53	
	4▽	○	1,5	32	60			5▽	○	4,1	48	65	
75▲	5▽	○	1,8	32	70		125	1	○	1,4	32	34	
	1	○	0,5	24	34			2	○	1,9	38	49	
	2	○	1,0	24	49			3	○	2,6	42	42	
	3	○	1,1	24	42			4▽	○	3,5	42	53	
	4▽	○	1,8	24	60			5▽	○	4,4	48	65	
80▲	5▽	○	1,9	28	82		132	1	○	1,5	32	34	
	1	○	0,6	28	34			2	○	2,2	38	49	
	2	○	1,0	32	49			3	○	2,6	42	42	
	3	○	1,2	38	42			4▽	○	3,6	42	53	
	4▽	○	1,9	38	60			5▽	○	4,8	48	65	
85	5▽	○	2,0	38	55		140	1	○	1,5	32	34	
	1	○	0,6	24	34			2	○	2,3	38	49	
	2	○	1,2	28	49			3	○	2,6	42	42	
	3	○	1,4	28	42			4▽	○	3,7	42	53	
	4▽	○	2,0	28	53			5▽	○	5,0	48	65	
90	5▽	○	2,2	32	55	150	1	×	1,6	38	36		
	1	○	0,9	28	34		2	×	2,6	38	49		
	2	○	1,5	32	49		3	○	3,0	42	42		
	3	○	1,6	38	42		4▽	○	4,0	42	53		
	4▽	○	2,2	42	53		5▽	○	5,2	48	65		
95	5▽	○	2,5	42	67	160	1	×	1,8	38	36		
	1	○	0,8	28	34		2	×	2,4	38	49		
	2	○	1,6	28	49		3	×	2,8	42	42		
	3	○	1,9	28	42		4▽	○	3,6	48	60		
	4▽	○	2,5	32	53		5▽	○	5,5	48	70		
100	5▽	○	2,8	35	67	170	1	×	2,0	35	36		
	1	○	0,8	28	34		2	×	2,9	35	49		
	2	○	1,4	32	49		3	×	3,2	35	42		
	3	○	2,0	38	42		4▽	×	4,2	35	60		
	4▽	○	2,7	42	53		5▽	×	5,8	38	70		
5▽	○	3,1	42	60									

▲ nur für Profil 13 only for section 13

▽ $d_d + 4$ mm

Anzahl der Rillen No. of grooves z	1	2	3	4	5
Kranzbreite Face width b_2 (mm)	20	35	50	67	82

- Vollscheibe Solid pulley
 - Bodenscheibe Plate pulley (mit oder ohne Spiegel with or without holes)
 - × Armscheibe Spoked pulley
- Nabenlage: einseitig bündig
Hub position: one side flush
Material: EN-GJL 200 – DIN EN 1561

Keilrillenscheiben für zylindrische Bohrung – Rillen nach DIN 2211 V-grooved pulleys for plain boring – grooves to ISO/BS/DIN

Profil Section SPA/13

Richtdurchmesser Datum diameter d_d (mm)	Anzahl der Rillen No. of grooves	Ausführung Type	Gewicht Weight (\approx kg)	Fertigbohrung Finished bore d_{max} (mm)	Nabenlänge Hub length l (mm)	€ Stück zentriert each centered	Richtdurchmesser Datum diameter d_d (mm)	Anzahl der Rillen No. of grooves	Ausführung Type	Gewicht Weight (\approx kg)	Fertigbohrung Finished bore d_{max} (mm)	Nabenlänge Hub length l (mm)	€ Stück zentriert each centered
180	1	×	2,0	38	36	auf Anfrage on request	315	1	×	4,8	48	44	auf Anfrage on request
	2	×	3,2	42	49			2	×	6,6	48	53	
	3	×	3,6	42	42			3	×	8,8	55	47	
	4 ∇	×	4,7	48	60			4 ∇	×	11,1	55	60	
	5 ∇	×	6,1	48	70			5 ∇	×	12,5	60	70	
190	1	×	2,0	38	36		355	1	×	5,5	48	44	
	2	×	3,2	42	49			2	×	7,7	55	53	
	3	×	4,0	42	42			3	×	9,6	55	47	
	4 ∇	×	5,2	48	60			4 ∇	×	11,8	55	60	
	5 ∇	×	6,3	48	70			5 ∇	×	13,8	60	70	
200	1	×	2,4	38	36		400	1 ∇	×	6,9	50	50	
	2	×	2,9	42	49			3 ∇	×	10,5	60	47	
	3	×	4,2	48	42			4 ∇	×	12,4	60	67	
	4 ∇	×	5,0	55	60			5 ∇	×	15,9	60	82	
	5 ∇	×	6,5	55	70			450	1 ∇	×	7,5	55	
212	1	×	2,7	40	36	2 ∇	×		9,4	55	53		
	2	×	3,4	42	49	3 ∇	×		12,2	60	47		
	3	×	4,4	42	42	4 ∇	×		14,2	65	67		
	4 ∇	×	5,7	42	60	5 ∇	×		18,3	65	82		
	5 ∇	×	6,9	42	70	500	2 ∇	×	10,7	55	55		
225	1	×	2,8	40	36		3 ∇	×	13,5	60	60		
	2	×	3,9	42	49		4 ∇	×	16,3	65	67		
	3	×	4,6	42	42		5 ∇	×	22,8	65	82		
	4 ∇	×	6,5	42	60		560	1 ∇	×	14,0	55	60	
	5 ∇	×	7,3	42	70	2 ∇		×	13,1	55	60		
236	1	×	3,3	38	36	3 ∇		×	15,6	60	74		
	2	×	4,1	42	49	4 ∇		×	19,4	65	67		
	3	×	4,9	48	47	250		1	×	3,4	42	36	
	4 ∇	×	6,2	55	60		2	×	4,3	48	49		
	5 ∇	×	7,5	55	70		3	×	5,3	48	47		
250	1	×	3,4	42	36		4 ∇	×	7,0	55	60		
	2	×	4,3	48	49		5 ∇	×	7,9	60	70		
	3	×	5,3	48	47	280	1	×	3,9	42	44		
	4 ∇	×	7,0	55	60		2	×	5,4	48	53		
	5 ∇	×	7,9	60	70		3	×	6,5	48	47		
280	1	×	3,9	42	44		4 ∇	×	8,5	55	60		
	2	×	5,4	48	53		5 ∇	×	9,9	60	70		
	3	×	6,5	48	47	300	1	×	4,3	48	44		
	4 ∇	×	8,5	55	60		2	×	5,9	48	53		
	5 ∇	×	9,9	60	70		3	×	7,5	55	47		
300	1	×	4,3	48	44		4 ∇	×	9,8	55	60		
	2	×	5,9	48	53		5 ∇	×	11,3	60	70		
	3	×	7,5	55	47	$\nabla d_d + 4 \text{ mm}$							
	4 ∇	×	9,8	55	60								
	5 ∇	×	11,3	60	70								

Anzahl der Rillen No. of grooves z	1	2	3	4	5
Kranzbreite Face width b_2 (mm)	20	35	50	67	82

- Vollscheibe Solid pulley
 - Bodenscheibe Plate pulley (mit oder ohne Spiegel with or without holes)
 - × Armscheibe Spoked pulley
- Nabenlage: einseitig bündig
Hub position: one side flush
Material: EN-GJL 200 – DIN EN 1561

Keilrillenscheiben für zylindrische Bohrung – Rillen nach DIN 2211 V-grooved pulleys for plain boring – grooves to ISO/BS/DIN

Profil Section SPB/17

Richtdurchmesser Datum diameter d_d (mm)	Anzahl der Rillen No. of grooves	Ausführung Type	Gewicht Weight (\approx kg)	Fertigbohrung Finished bore d_{max} (mm)	Nabenlänge Hub length l (mm)	€ Stück zentriert each centered	Richtdurchmesser Datum diameter d_d (mm)	Anzahl der Rillen No. of grooves	Ausführung Type	Gewicht Weight (\approx kg)	Fertigbohrung Finished bore d_{max} (mm)	Nabenlänge Hub length l (mm)	€ Stück zentriert each centered					
56▲	1	○	0,6	20	41	auf Anfrage on request	112▲	1	○	1,5	32	41	auf Anfrage on request					
	2	○	1,0	20	60			2	○	2,4	38	60						
	3	○	1,1	22	62			3	○	3,1	38	55						
63▲	1	○	0,8	20	41		4v	○	4,8	42	67	118▲		1	○	1,6	32	41
	2	○	1,2	20	60		5v	○	5,6	42	75			2	○	2,4	38	60
	3	○	1,2	22	62		6v	○	6,2	42	85			3	○	3,2	42	55
71▲	1	○	0,8	22	41		4v	○	5,2	42	70	125▲		1	○	1,7	32	41
	2	○	1,3	22	60		5v	○	7,2	42	75			2	○	2,6	38	60
	3	○	1,6	22	55		6v	○	6,6	42	85			3	○	3,3	42	55
75▲	1	○	0,8	25	41		4v	○	4,7	42	70	132▲		1	○	1,9	30	41
	2	○	1,4	25	60		5v	○	8,6	42	75			2	○	2,6	30	60
	3	○	1,9	25	62		6v	○	8,0	48	85			3	○	3,5	42	55
80▲	1	○	1,0	28	41		4v	○	6,3	42	70	140		1	○	2,1	32	41
	2	○	1,7	28	60		5v	○	9,4	42	75			2	○	2,9	38	60
	3	○	2,1	28	55		6v	○	8,5	42	85			3	○	3,9	42	55
	4v	○	2,4	28	70		150	1	○	2,4	32			43				
	5v	○	2,7	28	80			2	○	3,2	38			48				
85▲	1	○	1,1	30	41			3	○	4,3	42	60						
	2	○	1,7	30	60			4v	○	6,8	42	70						
	3	○	2,2	30	55			5v	○	8,4	48	75						
	4v	○	2,7	30	70		6v	○	12,1	48	85							
	5v	○	3,0	30	75		160	1	×	2,5	38	43						
90▲	1	○	1,2	32	41			2	×	3,3	42	48						
	2	○	1,8	38	60			3	×	4,6	48	60						
	3	○	2,3	38	55			4v	○	7,0	48	70						
	4v	○	3,1	38	70			5v	○	9,4	48	75						
	5v	○	3,3	38	75		6v	○	12,9	55	85							
95▲	1	○	1,3	35	41		170	1	×	2,9	42	43						
	2	○	2,0	38	60			2	×	3,4	42	48						
	3	○	2,5	38	67			3	×	4,9	42	60						
5v	○	3,6	38	75	4v		○	7,2	48	70								
100▲	1	○	1,3	32	41		5v	○	8,9	48	75							
	2	○	2,1	38	60		6v	○	13,1	48	85							
	3	○	2,9	38	55	▲ nur für Profil 17 only for section 17												
	4v	○	3,8	38	70	▽ $d_d + 5,5$ mm												
	5v	○	4,5	38	75													
	6v	○	5,2	38	124													
106▲	1	○	1,5	28	41													
	2	○	2,0	28	60													
	3	○	3,0	30	55													
	4v	○	4,3	30	70													
	5v	○	5,1	32	75													
	6v	○	6,0	32	124													

Anzahl der Rillen No. of grooves z	1	2	3	4	5	6
Kranzbreite Face width b_2 (mm)	25	44	63	86	105	124

- Vollscheibe Solid pulley
 - Bodenscheibe Plate pulley (mit oder ohne Spiegel with or without holes)
 - × Armscheibe Spoked pulley
- Nabenlage: einseitig bündig
Hub position: one side flush
Material: EN-GJL 200 – DIN EN 1561

Keilrillenscheiben für zylindrische Bohrung – Rillen nach DIN 2211 V-grooved pulleys for plain boring – grooves to ISO/BS/DIN

Profil Section SPB/17

Richtdurchmesser Datum diameter d_d (mm)	Anzahl der Rillen No. of grooves	Ausführung Type	Gewicht Weight (\approx kg)	Fertigbohrung Finished bore d_{max} (mm)	Nabenlänge Hub length l (mm)	€ Stück zentriert each centered	Richtdurchmesser Datum diameter d_d (mm)	Anzahl der Rillen No. of grooves	Ausführung Type	Gewicht Weight (\approx kg)	Fertigbohrung Finished bore d_{max} (mm)	Nabenlänge Hub length l (mm)	€ Stück zentriert each centered		
180	1	×	3,1	38	43	auf Anfrage on request	315	1	×	6,4	48	49	auf Anfrage on request		
	2	×	3,9	42	48			2	×	8,2	55	55			
	3	×	5,3	48	60			3	×	12,9	55	67			
	4 ∇	×	7,4	48	70			4 ∇	×	13,0	60	80			
	5 ∇	○	9,1	55	75			5 ∇	×	17,6	65	80			
	6 ∇	○	10,8	60	85			6 ∇	×	20,6	75	90			
190	1	×	3,2	42	43		355	1	×	7,0	48	49		auf Anfrage on request	
	2	×	4,2	42	48			2	×	9,7	55	55			
	3	×	5,5	42	60			3	×	13,4	55	67			
	4 ∇	×	7,7	48	70			4 ∇	×	18,3	60	80			
	5 ∇	○	9,2	50	75			5 ∇	×	18,8	65	75			
	6 ∇	○	12,0	55	85			6 ∇	×	19,8	75	90			
200	1	×	3,4	38	43		400	1 ∇	×	8,5	50	49			auf Anfrage on request
	2	×	4,5	42	48			2 ∇	×	10,0	55	55			
	3	×	5,9	48	60			3 ∇	×	14,3	60	67			
	4 ∇	×	8,0	50	60			4 ∇	×	18,5	65	80			
	5 ∇	○	9,5	55	80			5 ∇	×	22,5	70	85			
	6 ∇	○	12,2	60	90			6 ∇	×	28,0	75	90			
212	1	×	3,8	42	43	450	1 ∇	×	9,9	50	55	auf Anfrage on request			
	2	×	4,7	42	48		2 ∇	×	10,9	55	55				
	3	×	6,2	48	60		3 ∇	×	15,1	60	67				
	4 ∇	×	7,7	50	70		4 ∇	×	20,5	65	80				
	5 ∇	×	10,3	50	80		5 ∇	×	26,0	70	80				
	6 ∇	○	13,5	55	90		6 ∇	×	28,9	75	90				
225	1	×	4,0	42	43	500	1 ∇	×	10,7	50	55		auf Anfrage on request		
	2	×	5,4	42	48		2 ∇	×	13,7	60	59				
	3	×	6,9	48	60		3 ∇	×	15,2	65	67				
	4 ∇	×	8,6	55	70		4 ∇	×	21,3	70	80				
	5 ∇	○	11,7	50	90		5 ∇	×	30,0	75	80				
	6 ∇	○	14,8	55	90		6 ∇	×	33,8	80	90				
250	1	×	4,2	42	43	560	2 ∇	×	15,0	60	55			auf Anfrage on request	
	2	×	6,1	48	55		3 ∇	×	24,2	65	67				
	3	×	8,6	55	60		4 ∇	×	26,0	70	80				
	4 ∇	×	9,8	60	70		5 ∇	×	34,4	75	80				
	5 ∇	×	13,2	65	80		6 ∇	×	39,0	80	90				
	6 ∇	×	17,0	65	90		630	2 ∇	×	20,2	60				80
280	1	×	5,7	48	49	3 ∇		×	27,0	65	80				
	2	×	7,0	48	55	4 ∇		×	30,8	75	86				
	3	×	9,7	55	60	5 ∇		×	37,2	80	90				
	4 ∇	×	11,5	60	70	6 ∇		×	44,0	90	100				
	5 ∇	×	15,5	65	80	300		1	×	5,9	48	49			auf Anfrage on request
	6 ∇	×	18,0	65	90		2	×	7,5	48	55				
300	1	×	5,9	48	49		3	×	10,5	55	67				
	2	×	7,5	48	55		4 ∇	×	12,4	60	80				
	3	×	10,5	55	67		5 ∇	×	16,5	65	80				
	4 ∇	×	12,4	60	80		6 ∇	×	18,3	70	90				
	5 ∇	×	16,5	65	80	$\nabla d_d + 5,5 \text{ mm}$									
	6 ∇	×	18,3	70	90										

Anzahl der Rillen No. of grooves z	1	2	3	4	5	6
Kranzbreite Face width b_2 (mm)	25	44	63	86	105	124

- Vollscheibe Solid pulley
 - Bodenscheibe Plate pulley (mit oder ohne Spiegel with or without holes)
 - × Armscheibe Spoked pulley
- Nabenlage: einseitig bündig
Hub position: one side flush
Material: EN-GJL 200 – DIN EN 1561

Keilrillenscheiben für zylindrische Bohrung – Rillen nach DIN 2211 V-grooved pulleys for plain boring – grooves to ISO/BS/DIN

Profil Section SPC/22

Richtdurchmesser Datum diameter d_d (mm)	Anzahl der Rillen No. of grooves	Ausführung Type	Gewicht Weight (\approx kg)	Fertigbohrung Finished bore d_{max} (mm)	Nabellänge Hub length l (mm)	€ Stück zentriert each centered
180	1	○	4,2	40	54	auf Anfrage on request
	2	○	7,2	50	64	
	3	○	10,4	55	90	
	4	○	10,5	55	95	
	5	○	18,0	60	100	
	6	○	23,6	65	115	
200	1	○	4,8	40	54	
	2	○	7,8	50	64	
	3	○	8,8	55	90	
	4	○	11,2	60	95	
	5	○	15,4	65	100	
	6	○	27,0	70	125	
225	1	×	5,5	48	54	
	2	×	7,8	52	64	
	3	×	10,6	52	90	
	4	×	13,1	55	95	
	5	×	16,7	60	100	
	6	×	35,0	60	115	
250	1	×	7,3	52	54	
	2	×	8,8	52	64	
	3	×	11,0	65	90	
	4	×	15,3	70	95	
	5	×	19,0	75	100	
	6	×	23,7	60	115	
280	1	×	8,7	52	54	
	2	×	10,9	55	64	
	3	×	15,6	70	90	
	4	×	17,5	75	95	
	5	×	20,5	75	100	
315	1	×	9,1	52	54	
	2	×	13,0	55	74	
	3	×	17,1	70	90	
	4	×	20,0	75	95	
	5	×	24,7	80	100	
	6	×	31,2	85	115	
335	2	×	14,0	55	74	
	3	×	18,3	55	90	
	4	×	22,4	60	95	
	5	×	28,3	65	100	
	6	×	34,4	75	115	
	355	2	×	15,2	60	74
3		×	19,2	70	90	
4		×	25,8	70	95	
5		×	32,0	75	100	
6		×	36,2	75	115	

Richtdurchmesser Datum diameter d_d (mm)	Anzahl der Rillen No. of grooves	Ausführung Type	Gewicht Weight (\approx kg)	Fertigbohrung Finished bore d_{max} (mm)	Nabellänge Hub length l (mm)	€ Stück zentriert each centered
400	3	×	20,6	70	90	auf Anfrage on request
	4	×	28,0	70	105	
	5	×	32,0	75	100	
450	2	×	21,1	70	80	
	3	×	26,3	75	90	
	4	×	31,1	75	105	
500	5	×	42,2	80	110	
	6	×	48,5	80	120	
	560	3	×	28,4	75	
4		×	34,1	75	105	
5		×	48,2	80	110	
630	6	×	52,5	80	120	
	3	×	31,1	75	90	
	4	×	39,0	75	105	
630	5	×	54,1	80	110	
	6	×	61,5	85	120	
	3	×	38,5	80	90	
630	4	×	48,1	80	105	
	5	×	62,2	85	110	
	6	×	73,2	85	120	

22

Anzahl der Rillen No. of grooves z	1	2	3	4	5	6
Kranzbreite Face width b_2 (mm)	38	64	90	116	142	168

- Vollscheibe Solid pulley
 - Bodenscheibe Plate pulley (mit oder ohne Spiegel with or without holes)
 - × Armscheibe Spoked pulley
- Nabenlage: einseitig bündig
Hub position: one side flush
Material: EN-GJL 200 – DIN EN 1561

Regelscheiben Variable speed pulleys



Regelscheiben für zylindrische Bohrung *Variable speed pulleys for plain boring* Material: GG

Bezeichnung Part number	D _A (mm)	D (mm)	Fertig- bohrung Finished bore d _{d max} (mm)	B (mm)	Profil Section	d _{d min} (mm)	d _{d max} (mm)	Regel- faktor Variance factor	Gewicht Weight (≈ kg)	€ Stück zentriert each centered
R 083-1	83	40	26	48	SPZ	63	79	1,25	0,90	auf Anfrage on request
R 093-1	93	45	28	48	Z/10	57	77	1,35	1,03	
					SPA	66	87	1,32		
					Z/10	61	87	1,43		
R 108-1	108	50	28	48	A/13	60	85	1,42	1,65	
					SPZ	79	94	1,19		
					SPA	81	102	1,26		
R 121-1	121	55	28	48	Z/10	73	93	1,27	1,75	
					A/13	75	100	1,33		
					SPZ	92	107	1,16		
R 121-1	121	55	28	48	SPA	94	115	1,22	1,75	
					Z/10	86	106	1,23		
					A/13	88	113	1,28		
R 138-1	138	55	38	48	SPZ	109	124	1,14	2,60	
					SPA	111	132	1,19		
					SPB	116	131	1,13		
					Z/10	103	123	1,19		
					A/13	105	130	1,24		
R 160-1	160	80	52	48	B/17	109	128	1,17	4,50	
					SPZ	119	134	1,13		
					SPA	121	143	1,18		
					SPB	126	153	1,21		
					Z/10	113	133	1,18		
R 180-1	180	80	52	48	A/13	115	141	1,23	5,40	
					B/17	119	150	1,26		
					SPA	141	163	1,16		
					SPB	146	173	1,18		
R 180-1	180	80	52	48	A/13	135	161	1,19	5,40	
					B/17	139	170	1,22		
					SPA	141	163	1,16		

Regelscheiben Variable speed pulleys

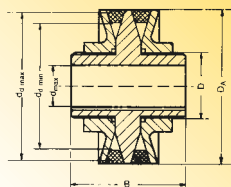
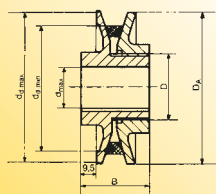

Regelscheiben für zylindrische Bohrung Variable speed pulleys for plain boring Material: GG

Bezeichnung Part number	D _A (mm)	D (mm)	Fertig- bohrung Finished bore d _{d max} (mm)	B (mm)	Profil Section	d _{d min} (mm)	d _{d max} (mm)	Regel- faktor Variance factor	Gewicht Weight (≈ kg)	€ Stück zentriert each centered
R 083-2	83	40	26	76	SPZ Z/10	63 57	79 77	1,25 1,35	1,50	auf Anfrage on request
R 093-2	93	45	28	76	SPZ SPA Z/10	67 66 61	89 87 87	1,33 1,32 1,43	1,75	
R 108-2	108	50	28	76	SPZ SPA Z/10 A/13	79 81 73 75	94 102 93 100	1,19 1,26 1,27 1,33	2,15	
R 121-2	121	55	28	76	SPZ SPA Z/10 A/13	92 94 86 88	107 115 106 113	1,16 1,22 1,23 1,28	2,70	
R 138-2	138	55	38	76	SPZ SPA SPB Z/10 A/13 B/17	109 111 116 103 105 109	124 132 131 123 130 128	1,14 1,19 1,13 1,19 1,24 1,17	4,50	
R 160-2	160	80	52	90	SPZ SPA SPB Z/10 A/13 B/17	119 121 126 113 115 119	134 143 153 133 141 150	1,13 1,18 1,21 1,18 1,23 1,26	7,50	
R 180-2	180	80	52	90	SPA SPB A/13 B/17	141 146 135 139	163 173 161 170	1,16 1,18 1,19 1,22	9,20	

Regelscheiben Variable speed pulleys

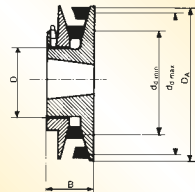

Regelscheiben für Taperbuchsen *Variable speed pulleys for taper bushes* Material: GG

Bezeichnung Part number	D _A (mm)	D (mm)	Fertig- bohrung Finished bore d _{max} (mm)	B (mm)	Profil Section	d _{d min} (mm)	d _{d max} (mm)	Regel- faktor Variance factor	Gewicht ohne Buchse Weight without bush (= kg)	Taper- Buchse Taper bush	€ Stück ohne Buchse each without bush
TB-R 092-1	92	46	25	31	SPZ	60	89	1,48	0,85	1008	auf Anfrage on request
TB-R 108-1	108	50	28	35	Z/10	55	88	1,60	1,20	1108	
					SPA	76	102	1,34			
					Z/10	68	92	1,35			
					A/13	70	100	1,43			
TB-R 120-1	120	55	28	35	B/17	87	97	1,11			
					SPZ	87	105	1,20			
					SPA	88	114	1,29			
					Z/10	80	104	1,30			
TB-R 138-1	138	65	32	38	A/13	82	112	1,36			
					B/17	98	108	1,10			
					SPZ	105	123	1,17			
					SPA	106	132	1,24			
TB-R 159-1	159	75	42	39	Z/10	98	122	1,24			
					A/13	100	130	1,30			
					B/17	116	126	1,09			
					SPZ	126	144	1,14			
TB-R 180-1	180	75	42	45	SPA	128	154	1,20			
					Z/10	122	152	1,24			
					A/13	128	152	1,18			
					B/17	125	148	1,18			
					SPZ	133	151	1,14			
					SPA	134	160	1,19			
					SPB	137	173	1,26			
Z/10	128	151	1,17								
A/13	128	158	1,23								
B/17	132	170	1,29								

Taperbuchse <i>Taper bush</i>	1008	1108	1215	1615
Bohrung d ₂ (mm) von ... bis ... Bore d ₂ (mm) from ... to ...	10-25	10-28	11-32	14-42
€/Stück each	auf Anfrage / on request			

GG = Grauguss Cast iron
Fertigungstechnische Änderungen vorbehalten.
We reserve the right to make technical changes.

Bohrungsdurchmesser d₂ siehe Seite 3-4.
Bore diameters d₂ see page 3-4.

Keilrippenscheiben für Taperbuchsen, Profil PJ

Ribbed belt pulleys for taper bushes, section PJ

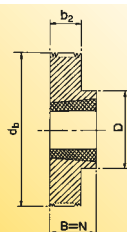

Ausf. Type 1

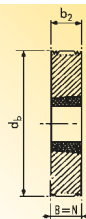

Ausf. Type 4

Bezeichnung Part number	Anzahl der Rillen No. of ribs	Aus- führung Type	Material	db (mm)	b ₂ (mm)	B (mm)	N (mm)	D (mm)	Taper- Buchse Taper bush	€ Stück ohne Buchse each without bush
TB 4 PJ 47,5	4	1	GG	47,5	13	23	23	47,5	1008	
TB 4 PJ 52,5	4	1	GG	52,5	13	23	23	47,5	1008	
TB 4 PJ 57,5	4	1	GG	57,5	13	23	23	54,0	1108	
TB 4 PJ 62,5	4	1	GG	62,5	13	23	23	54,0	1108	
TB 4 PJ 67,5	4	1	GG	67,5	13	23	23	54,0	1108	
TB 4 PJ 72,5	4	1	GG	72,5	13	23	23	54,0	1108	
TB 4 PJ 77,5	4	1	GG	77,5	13	26	26	70,0	1210	
TB 4 PJ 82,5	4	1	GG	82,5	13	26	26	78,0	1210	
TB 4 PJ 87,5	4	1	GG	87,5	13	26	26	78,0	1210	
TB 4 PJ 92,5	4	1	GG	92,5	13	26	26	78,0	1210	
TB 4 PJ 97,5	4	1	GG	97,5	13	26	26	78,0	1210	
TB 4 PJ 102,5	4	1	GG	102,5	13	26	26	85,0	1610	
TB 4 PJ 107,5	4	1	GG	107,5	13	26	26	85,0	1610	
TB 4 PJ 112,5	4	1	GG	112,5	13	26	26	85,0	1610	
TB 4 PJ 117,5	4	1	GG	117,5	13	26	26	85,0	1610	
TB 4 PJ 122,5	4	1	GG	122,5	13	26	26	85,0	1610	
TB 4 PJ 127,5	4	1	GG	127,5	13	26	26	85,0	1610	
TB 4 PJ 137,5	4	1	GG	137,5	13	26	26	85,0	1610	
TB 4 PJ 152,5	4	1	GG	152,5	13	26	26	85,0	1610	
TB 4 PJ 162,5	4	1	GG	162,5	13	26	26	85,0	1610	
TB 4 PJ 172,5	4	1	GG	172,5	13	26	26	85,0	1610	
TB 4 PJ 182,5	4	1	GG	182,5	13	26	26	85,0	1610	
TB 4 PJ 192,5	4	1	GG	192,5	13	26	26	85,0	1610	
TB 4 PJ 202,5	4	1	GG	202,5	13	33	33	100,0	2012	
TB 4 PJ 222,5	4	1	GG	222,5	13	33	33	100,0	2012	
TB 8 PJ 47,5	8	4	GG	47,5	23	23	23	—	1008	auf Anfrage on request
TB 8 PJ 52,5	8	4	GG	52,5	23	23	23	—	1008	
TB 8 PJ 57,5	8	4	GG	57,5	23	23	23	—	1108	
TB 8 PJ 62,5	8	4	GG	62,5	23	23	23	—	1108	
TB 8 PJ 67,5	8	4	GG	67,5	23	23	23	—	1108	
TB 8 PJ 72,5	8	4	GG	72,5	23	23	23	—	1108	
TB 8 PJ 77,5	8	1	GG	77,5	23	26	26	70,0	1210	
TB 8 PJ 82,5	8	1	GG	82,5	23	26	26	78,0	1210	
TB 8 PJ 87,5	8	1	GG	87,5	23	26	26	78,0	1210	
TB 8 PJ 92,5	8	1	GG	92,5	23	26	26	78,0	1210	
TB 8 PJ 97,5	8	1	GG	97,5	23	26	26	78,0	1210	
TB 8 PJ 102,5	8	1	GG	102,5	23	26	26	85,0	1610	
TB 8 PJ 107,5	8	1	GG	107,5	23	26	26	85,0	1610	
TB 8 PJ 112,5	8	1	GG	112,5	23	26	26	85,0	1610	
TB 8 PJ 117,5	8	1	GG	117,5	23	26	26	85,0	1610	
TB 8 PJ 122,5	8	1	GG	122,5	23	26	26	85,0	1610	
TB 8 PJ 127,5	8	1	GG	127,5	23	26	26	85,0	1610	
TB 8 PJ 137,5	8	1	GG	137,5	23	26	26	85,0	1610	
TB 8 PJ 152,5	8	1	GG	152,5	23	26	26	85,0	1610	
TB 8 PJ 162,5	8	1	GG	162,5	23	26	26	85,0	1610	
TB 8 PJ 172,5	8	1	GG	172,5	23	26	26	85,0	1610	
TB 8 PJ 182,5	8	1	GG	182,5	23	26	26	85,0	1610	
TB 8 PJ 192,5	8	1	GG	192,5	23	26	26	85,0	1610	
TB 8 PJ 202,5	8	1	GG	202,5	23	33	33	100,0	2012	
TB 8 PJ 222,5	8	1	GG	222,5	23	33	33	100,0	2012	

Taperbuchse Taper bush	1008	1108	1210	1610	2012
Bohrung d ₂ (mm) von ... bis ... Bore d ₂ (mm) from ... to ...	10-25	10-28	11-32	14-42	14-50
€/Stück each	auf Anfrage / on request				

GG = Grauguss Cast iron
 Weitere Abmessungen auf Anfrage.
 Further sizes on request.
 Fertigungstechnische Änderungen vorbehalten.
 We reserve the right to make technical changes.
 Bohrungsdurchmesser d₂ siehe Seite 3-4.
 Bore diameters d₂ see page 3-4.

Keilrippenscheiben für Taperbuchsen, Profil PJ Ribbed belt pulleys for taper bushes, section PJ

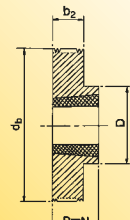

Ausf. Type 1

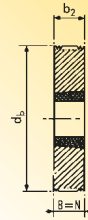

Ausf. Type 4

Bezeichnung Part number	Anzahl der Rillen No. of ribs	Aus- führung Type	Material	d _b (mm)	b ₂ (mm)	B (mm)	N (mm)	D (mm)	Taper- Buchse Taper bush	€ Stück ohne Buchse each without bush
TB 12 PJ 62,5	12	2	GG	62,5	32	32	23	50,0	1108	
TB 12 PJ 67,5	12	2	GG	67,5	32	32	23	50,0	1108	
TB 12 PJ 72,5	12	2	GG	72,5	32	32	23	50,0	1108	
TB 12 PJ 77,5	12	2	GG	77,5	32	32	26	62,0	1210	
TB 12 PJ 82,5	12	2	GG	82,5	32	32	26	62,0	1210	
TB 12 PJ 87,5	12	2	GG	87,5	32	32	26	70,0	1610	
TB 12 PJ 92,5	12	2	GG	92,5	32	32	26	70,0	1610	
TB 12 PJ 97,5	12	2	GG	97,5	32	32	26	70,0	1610	
TB 12 PJ 102,5	12	2	GG	102,5	32	32	26	70,0	1610	
TB 12 PJ 107,5	12	2	GG	107,5	32	32	26	70,0	1610	
TB 12 PJ 112,5	12	2	GG	112,5	32	32	26	70,0	1610	
TB 12 PJ 117,5	12	2	GG	117,5	32	32	26	70,0	1610	
TB 12 PJ 122,5	12	2	GG	122,5	32	32	26	70,0	1610	
TB 12 PJ 127,5	12	1	GG	127,5	32	32	33	100,0	2012	
TB 12 PJ 137,5	12	1	GG	137,5	32	32	33	100,0	2012	
TB 12 PJ 152,5	12	1	GG	152,5	32	32	33	100,0	2012	
TB 12 PJ 162,5	12	1	GG	162,5	32	32	33	100,0	2012	
TB 12 PJ 172,5	12	1	GG	172,5	32	32	33	100,0	2012	
TB 12 PJ 182,5	12	1	GG	182,5	32	46	46	110,0	2517	
TB 12 PJ 192,5	12	1	GG	192,5	32	46	46	110,0	2517	
TB 12 PJ 202,5	12	1	GG	202,5	32	46	46	110,0	2517	
TB 12 PJ 222,5	12	1	GG	222,5	32	46	46	110,0	2517	
TB 16 PJ 62,5	16	2	GG	62,5	41	41	23	50,0	1108	auf Anfrage on request
TB 16 PJ 67,5	16	2	GG	67,5	41	41	23	50,0	1108	
TB 16 PJ 72,5	16	2	GG	72,5	41	41	26	62,0	1210	
TB 16 PJ 77,5	16	2	GG	77,5	41	41	26	62,0	1210	
TB 16 PJ 82,5	16	2	GG	82,5	41	41	26	62,0	1210	
TB 16 PJ 87,5	16	2	GG	87,5	41	41	26	70,0	1610	
TB 16 PJ 92,5	16	2	GG	92,5	41	41	26	70,0	1610	
TB 16 PJ 97,5	16	2	GG	97,5	41	41	26	70,0	1610	
TB 16 PJ 102,5	16	2	GG	102,5	41	41	26	70,0	1610	
TB 16 PJ 107,5	16	2	GG	107,5	41	41	26	70,0	1610	
TB 16 PJ 112,5	16	2	GG	112,5	41	41	33	85,0	2012	
TB 16 PJ 117,5	16	2	GG	117,5	41	41	33	85,0	2012	
TB 16 PJ 122,5	16	2	GG	122,5	41	41	33	85,0	2012	
TB 16 PJ 127,5	16	2	GG	127,5	41	41	33	85,0	2012	
TB 16 PJ 137,5	16	2	GG	137,5	41	41	33	85,0	2012	
TB 16 PJ 152,5	16	2	GG	152,5	41	41	33	85,0	2012	
TB 16 PJ 162,5	16	2	GG	162,5	41	41	33	85,0	2012	
TB 16 PJ 172,5	16	2	GG	172,5	41	41	33	85,0	2012	
TB 16 PJ 182,5	16	1	GG	182,5	41	46	46	110,0	2517	
TB 16 PJ 192,5	16	1	GG	192,5	41	46	46	110,0	2517	
TB 16 PJ 202,5	16	1	GG	202,5	41	46	46	110,0	2517	
TB 16 PJ 222,5	16	1	GG	222,5	41	46	46	110,0	2517	

Taperbuchse Taper bush	1108	1210	1610	2012	2517
Bohrung d ₂ (mm) von ... bis ... Bore d ₂ (mm) from ... to ...	10-28	11-32	14-42	14-50	16-60
€/Stück each	auf Anfrage / on request				

GG = Grauguss Cast iron
 Weitere Abmessungen auf Anfrage.
 Further sizes on request.
 Fertigungstechnische Änderungen vorbehalten.
 We reserve the right to make technical changes.
 Bohrungsdurchmesser d₂ siehe Seite 3-4.
 Bore diameters d₂ see page 3-4.

Keilrippenscheiben für Taperbuchsen, Profil PL Ribbed belt pulleys for taper bushes, section PL

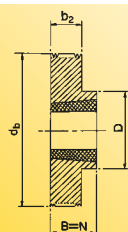

Ausf. Type 1

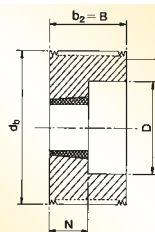

Ausf. Type 2

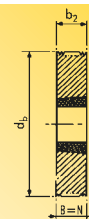

Ausf. Type 4

Bezeichnung Part number	Anzahl der Rillen No. of ribs	Aus- führung Type	Material	d _b (mm)	b ₂ (mm)	B (mm)	N (mm)	D (mm)	Taper- Buchse Taper bush	€ Stück ohne Buchse each without bush
TB 6 PL 78	6	2	GG	78	33	33	26	62,0	1210	auf Anfrage on request
TB 6 PL 83	6	2	GG	83	33	33	26	62,0	1210	
TB 6 PL 88	6	2	GG	88	33	33	26	70,0	1610	
TB 6 PL 93	6	2	GG	93	33	33	26	70,0	1610	
TB 6 PL 98	6	2	GG	98	33	33	26	70,0	1610	
TB 6 PL 103	6	2	GG	103	33	33	26	70,0	1610	
TB 6 PL 108	6	2	GG	108	33	33	26	70,0	1610	
TB 6 PL 113	6	2	GG	113	33	33	26	70,0	1610	
TB 6 PL 118	6	2	GG	118	33	33	26	70,0	1610	
TB 6 PL 123	6	4	GG	123	33	33	33	—	2012	
TB 6 PL 133	6	4	GG	133	33	33	33	—	2012	
TB 6 PL 148	6	4	GG	148	33	33	33	—	2012	
TB 6 PL 158	6	4	GG	158	33	33	33	—	2012	
TB 6 PL 168	6	4	GG	168	33	33	33	—	2012	
TB 6 PL 178	6	1	GG	178	33	46	46	110,0	2517	
TB 6 PL 188	6	1	GG	188	33	46	46	110,0	2517	
TB 6 PL 198	6	1	GG	198	33	46	46	110,0	2517	
TB 6 PL 218	6	1	GG	218	33	46	46	110,0	2517	
TB 6 PL 238	6	1	GG	238	33	46	46	110,0	2517	
TB 6 PL 258	6	1	GG	258	33	46	46	110,0	2517	
TB 6 PL 278	6	1	GG	278	33	46	46	110,0	2517	
TB 6 PL 298	6	1	GG	298	33	46	46	110,0	2517	
TB 6 PL 318	6	1	GG	318	33	46	46	110,0	2517	
TB 6 PL 348	6	1	GG	348	33	46	46	110,0	2517	
TB 6 PL 388	6	1	GG	388	33	46	46	110,0	2517	
TB 8 PL 78	8	2	GG	78	42	42	26	62,0	1210	
TB 8 PL 83	8	2	GG	83	42	42	26	62,0	1210	
TB 8 PL 88	8	2	GG	88	42	42	26	70,0	1610	
TB 8 PL 93	8	2	GG	93	42	42	26	70,0	1610	
TB 8 PL 98	8	2	GG	98	42	42	26	70,0	1610	
TB 8 PL 103	8	2	GG	103	42	42	33	85,0	2012	
TB 8 PL 108	8	2	GG	108	42	42	33	85,0	2012	
TB 8 PL 113	8	2	GG	113	42	42	33	85,0	2012	
TB 8 PL 118	8	2	GG	118	42	42	33	85,0	2012	
TB 8 PL 123	8	2	GG	123	42	42	33	85,0	2012	
TB 8 PL 133	8	2	GG	133	42	42	33	85,0	2012	
TB 8 PL 148	8	2	GG	148	42	42	33	85,0	2012	
TB 8 PL 158	8	2	GG	158	42	42	33	85,0	2012	
TB 8 PL 168	8	2	GG	168	42	42	33	85,0	2012	
TB 8 PL 178	8	1	GG	178	42	46	46	110,0	2517	
TB 8 PL 188	8	1	GG	188	42	46	46	110,0	2517	
TB 8 PL 198	8	1	GG	198	42	46	46	110,0	2517	
TB 8 PL 218	8	1	GG	218	42	46	46	110,0	2517	
TB 8 PL 238	8	1	GG	238	42	46	46	110,0	2517	
TB 8 PL 258	8	1	GG	258	42	46	46	110,0	2517	
TB 8 PL 278	8	1	GG	278	42	46	46	110,0	2517	
TB 8 PL 298	8	1	GG	298	42	46	46	110,0	2517	
TB 8 PL 318	8	1	GG	318	42	46	46	110,0	2517	
TB 8 PL 348	8	1	GG	348	42	46	46	110,0	2517	
TB 8 PL 388	8	1	GG	388	42	46	46	110,0	2517	

Taperbuchse Taper bush	1210	1610	2012	2517
Bohrung d ₂ (mm) von ... bis ... Bore d ₂ (mm) from ... to ...	11-32	14-42	14-50	16-60
€/Stück each	auf Anfrage / on request			

GG = Grauguss Cast iron
Weitere Abmessungen auf Anfrage.
Further sizes on request.
Fertigungstechnische Änderungen vorbehalten.
We reserve the right to make technical changes.
Bohrungsdurchmesser d₂ siehe Seite 3-4.
Bore diameters d₂ see page 3-4.

Keilrippenscheiben für Taperbuchsen, Profil PL Ribbed belt pulleys for taper bushes, section PL

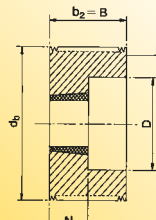

Ausf. Type 2

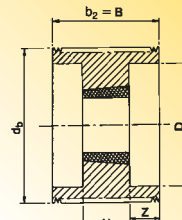

Ausf. Type 3

Bezeichnung Part number	Anzahl der Rillen No. of ribs	Aus- führung Type	Material	d _b (mm)	b ₂ (mm)	B (mm)	N (mm)	D (mm)	Taper- Buchse Taper bush	€ Stück ohne Buchse each without bush
TB 10 PL 88	10	3	GG	88	53	53	26	70,0	1610	auf Anfrage on request
TB 10 PL 93	10	3	GG	93	53	53	26	70,0	1610	
TB 10 PL 98	10	3	GG	98	53	53	26	70,0	1610	
TB 10 PL 103	10	2	GG	103	53	53	33	85,0	2012	
TB 10 PL 108	10	2	GG	108	53	53	33	85,0	2012	
TB 10 PL 118	10	2	GG	118	53	53	33	85,0	2012	
TB 10 PL 123	10	2	GG	123	53	53	33	85,0	2012	
TB 10 PL 133	10	2	GG	133	53	53	33	85,0	2012	
TB 10 PL 148	10	2	GG	148	53	53	33	85,0	2012	
TB 10 PL 158	10	2	GG	158	53	53	33	85,0	2012	
TB 10 PL 168	10	2	GG	168	53	53	33	85,0	2012	
TB 10 PL 178	10	2	GG	178	53	53	46	105,0	2517	
TB 10 PL 188	10	2	GG	188	53	53	46	105,0	2517	
TB 10 PL 198	10	2	GG	198	53	53	46	105,0	2517	
TB 10 PL 218	10	2	GG	218	53	53	46	105,0	2517	
TB 10 PL 238	10	2	GG	238	53	53	46	105,0	2517	
TB 10 PL 258	10	2	GG	258	53	53	46	105,0	2517	
TB 10 PL 278	10	2	GG	278	53	53	46	105,0	2517	
TB 10 PL 298	10	2	GG	298	53	53	46	105,0	2517	
TB 10 PL 318	10	2	GG	318	53	53	46	105,0	2517	
TB 10 PL 348	10	2	GG	348	53	53	46	105,0	2517	
TB 10 PL 388	10	2	GG	388	53	53	46	105,0	2517	
TB 12 PL 88	12	3	GG	88	62	62	26	70,0	1610	
TB 12 PL 93	12	3	GG	93	62	62	26	70,0	1610	
TB 12 PL 98	12	3	GG	98	62	62	26	70,0	1610	
TB 12 PL 103	12	3	GG	103	62	62	33	85,0	2012	
TB 12 PL 108	12	3	GG	108	62	62	33	85,0	2012	
TB 12 PL 113	12	3	GG	113	62	62	33	85,0	2012	
TB 12 PL 118	12	3	GG	118	62	62	33	85,0	2012	
TB 12 PL 123	12	3	GG	123	62	62	33	85,0	2012	
TB 12 PL 133	12	3	GG	133	62	62	33	85,0	2012	
TB 12 PL 148	12	2	GG	148	62	62	46	105,0	2517	
TB 12 PL 158	12	2	GG	158	62	62	46	105,0	2517	
TB 12 PL 168	12	2	GG	168	62	62	46	105,0	2517	
TB 12 PL 178	12	2	GG	178	62	62	46	105,0	2517	
TB 12 PL 188	12	2	GG	188	62	62	46	105,0	2517	
TB 12 PL 198	12	2	GG	198	62	62	46	105,0	2517	
TB 12 PL 218	12	2	GG	218	62	62	46	105,0	2517	
TB 12 PL 238	12	2	GG	238	62	62	52	130,0	3020	
TB 12 PL 258	12	2	GG	258	62	62	52	130,0	3020	
TB 12 PL 278	12	2	GG	278	62	62	52	130,0	3020	
TB 12 PL 298	12	2	GG	298	62	62	52	130,0	3020	
TB 12 PL 318	12	2	GG	318	62	62	52	130,0	3020	
TB 12 PL 348	12	2	GG	348	62	62	52	130,0	3020	
TB 12 PL 388	12	2	GG	388	62	62	52	130,0	3020	

Taperbuchse Taper bush	1610	2012	2517	3020
Bohrung d ₂ (mm) von ... bis ... Bore d ₂ (mm) from ... to ...	14-42	14-50	16-60	25-75
€/Stück each	auf Anfrage / on request			

GG = Grauguss Cast iron
Weitere Abmessungen auf Anfrage.
Further sizes on request.
Fertigungstechnische Änderungen vorbehalten.
We reserve the right to make technical changes.
Bohrungsdurchmesser d₂ siehe Seite 3-4.
Bore diameters d₂ see page 3-4.

Keilrippenscheiben für Taperbuchsen, Profil PL Ribbed belt pulleys for taper bushes, section PL

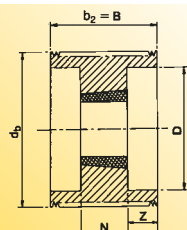

Ausf. Type 3

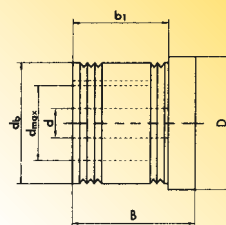

Ausf. Type VB (für zyl. Bohrung for plain boring)

Bezeichnung Part number	Anzahl der Rillen No. of ribs	Ausführung Type	Material	d _b (mm)	b ₂ (mm)	B (mm)	N (mm)	D (mm)	Taper-Buchse Taper bush	€ Stück ohne Buchse each without bush
TB 16 PL 103	16	3	GG	103	80	80	33	85,0	2012	auf Anfrage on request
TB 16 PL 108	16	3	GG	108	80	80	33	85,0	2012	
TB 16 PL 113	16	3	GG	113	80	80	33	85,0	2012	
TB 16 PL 118	16	3	GG	118	80	80	33	85,0	2012	
TB 16 PL 123	16	3	GG	123	80	80	33	85,0	2012	
TB 16 PL 133	16	3	GG	133	80	80	33	85,0	2012	
TB 16 PL 148	16	3	GG	148	80	80	46	105,0	2517	
TB 16 PL 158	16	3	GG	158	80	80	46	105,0	2517	
TB 16 PL 168	16	3	GG	168	80	80	46	105,0	2517	
TB 16 PL 178	16	3	GG	178	80	80	46	105,0	2517	
TB 16 PL 188	16	3	GG	188	80	80	46	105,0	2517	
TB 16 PL 198	16	3	GG	198	80	80	46	105,0	2517	
TB 16 PL 218	16	3	GG	218	80	80	46	105,0	2517	
TB 16 PL 238	16	3	GG	238	80	80	52	130,0	3020	
TB 16 PL 258	16	3	GG	258	80	80	52	130,0	3020	
TB 16 PL 278	16	3	GG	278	80	80	52	130,0	3020	
TB 16 PL 298	16	3	GG	298	80	80	52	130,0	3020	
TB 16 PL 318	16	3	GG	318	80	80	52	130,0	3020	
TB 16 PL 348	16	3	GG	348	80	80	52	130,0	3020	
TB 16 PL 388	16	3	GG	388	80	80	52	130,0	3020	

Taperbuchse Taper bush	2012	2517	3020
Bohrung d ₂ (mm) von ... bis ... Bore d ₂ (mm) from ... to ...	14-50	16-60	25-75
€/Stück each	auf Anfrage / on request		

Bohrungsdurchmesser d₂ siehe Seite 3-4.
Bore diameters d₂ see page 3-4.

Keilrippenscheiben mit zylindrischer Bohrung, Profil PJ Ribbed belt pulleys for plain boring, section PJ

Bezeichnung Part number	Anzahl der Rillen No. of ribs	Ausführung Type	Material	d _b (mm)	b ₁ (mm)	B (mm)	D (mm)	Vorbohrung Pilot bore d (mm)	Fertigbohrung Finished bore d _{max} (mm)	Gewicht Weight (= kg)	€ Stück each
4 PJ 22,5	4	VB	GG	22,5	13	20	25	8	12,0	0,045	auf Anfrage on request
4 PJ 27,5	4	VB	GG	27,5	13	20	30	8	14,0	0,070	
4 PJ 32,5	4	VB	GG	32,5	13	20	35	8	18,0	0,100	
4 PJ 37,5	4	VB	GG	37,5	13	20	40	8	20,0	0,135	
4 PJ 42,5	4	VB	GG	42,5	13	20	45	8	22,0	0,180	
8 PJ 22,5	8	VB	GG	22,5	23	30	25	8	12,0	0,063	
8 PJ 27,5	8	VB	GG	27,5	23	30	30	8	14,0	0,100	
8 PJ 32,5	8	VB	GG	32,5	23	30	35	8	18,0	0,150	
8 PJ 37,5	8	VB	GG	37,5	23	30	40	8	20,0	0,200	
8 PJ 42,5	8	VB	GG	42,5	23	30	45	8	22,0	0,265	
12 PJ 22,5	12	VB	GG	22,5	32	40	25	8	12,0	0,086	
12 PJ 27,5	12	VB	GG	27,5	32	40	30	8	14,0	0,140	
12 PJ 32,5	12	VB	GG	32,5	32	40	35	8	18,0	0,200	
12 PJ 37,5	12	VB	GG	37,5	32	40	40	8	20,0	0,280	
12 PJ 42,5	12	VB	GG	42,5	32	40	45	8	22,0	0,360	

GG = Grauguss Cast iron

Weitere Abmessungen auf Anfrage. Further sizes on request. Fertigungstechnische Änderungen vorbehalten. We reserve the right to make technical changes.

Flachriemenscheiben für Taperbuchsen Flat belt pulleys for taper bushes



Außendurchmesser x Breite Outside diameter x width (mm)	Taperbuchse Taper bush	€ Stück ohne Buchse each without bush	Außendurchmesser x Breite Outside diameter x width (mm)	Taperbuchse Taper bush	€ Stück ohne Buchse each without bush
63 x 50	1108	auf Anfrage on request	224 x 50	2517	auf Anfrage on request
80 x 50	1210		224 x 80	2517	
80 x 80	1615		224 x 100	3020	
90 x 50	1615		224 x 125	3030	
90 x 80	1615		224 x 160	3030	
90 x 100	1615		250 x 80	2517	
100 x 50	1615		250 x 100	3020	
100 x 80	1615		250 x 125	3030	
100 x 100	1615		250 x 160	3030	
125 x 50	2012		280 x 100	3020	
125 x 80	2517		280 x 125	3030	
125 x 100	2517		280 x 160	3535	
125 x 125	2517		280 x 200	4040	
140 x 50	2012		315 x 100	3020	
140 x 80	2517		315 x 125	3030	
140 x 100	3020		315 x 160	3535	
140 x 125	3030		315 x 200	4040	
150 x 50	2012		355 x 100	3030	
150 x 80	2517		355 x 125	3030	
150 x 100	3020		355 x 160	3535	
150 x 125	3030		355 x 200	4040	
150 x 160	3030		400 x 100	3535	
160 x 50	2012		400 x 125	3535	
160 x 80	2517		400 x 160	3535	
160 x 100	3020		400 x 200	4040	
160 x 125	3030		450 x 160	3535	
160 x 160	3030		450 x 200	4040	
180 x 80	2517		500 x 160	4040	
180 x 100	3020		500 x 200	4545	
180 x 125	3030		560 x 160	4040	
180 x 160	3030	560 x 200	4545		
200 x 80	2517	630 x 160	4545		
200 x 100	3020	630 x 200	5050		
200 x 125	3030				
200 x 160	3030				

Taperbuchse Taper bush	1108	1210	1615	2012	2517	3020	3030	3535	4040	4545	5050
Bohrung d ₂ (mm) von ... bis ... Bore d ₂ (mm) from ... to ...	10-28	11-32	14-42	14-50	16-60	25-75	35-75	35-90	40-100	55-110	70-125
€/Stück each	auf Anfrage / on request										

Motorspannschienen

Motor slide rails

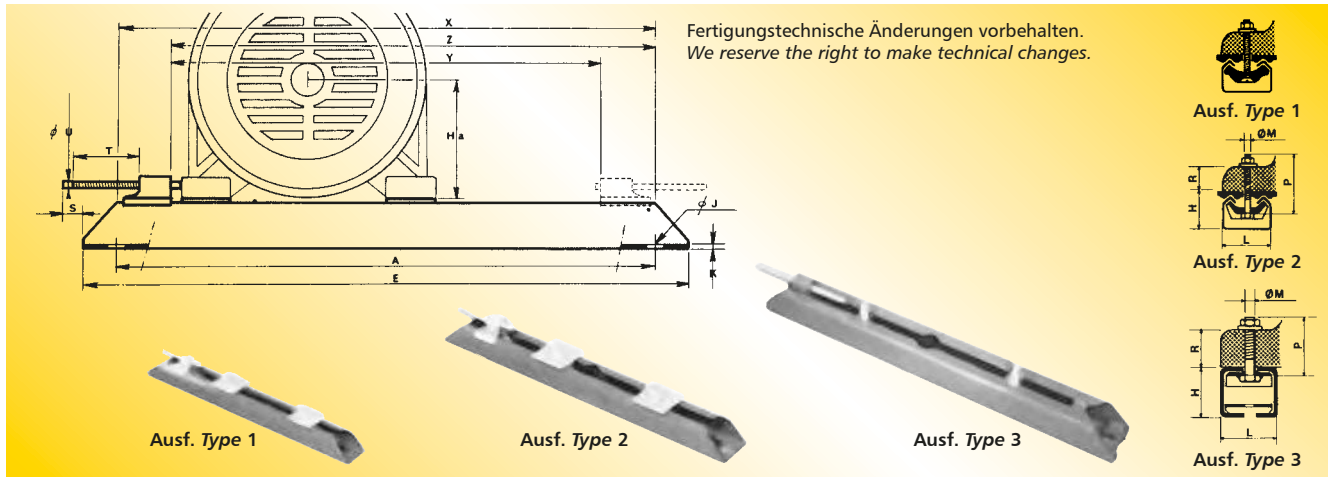

Bezeichnung Part number	S71/6VS	N300/6VS	S100/8VS	S132/10VS	N600/10VS	S180/12VS	S225/16GS	S280/20GS	S355/24GS	
Ausführung Type	1	1	2	2	2	2	3	3	3	
Motorachshöhe Motor shaft centre height Ha (mm)	56/63/71	80	80/90/100	100/112/132	160	160/180	200/225	250/280	315/355	
Abmessungen Dimensions	A (mm)	280,0	343,0	355,0	480,0	580,0	630,0	800,0	1000,0	1250,0
	E (mm)	312,0	375,0	395,0	530,0	630,0	686,0	864,0	1072,0	1330,0
	H (mm)	28,0	28,0	40,0	49,5	49,5	60,5	75,0	100,0	125,0
	Ø J (mm)	10,5	10,5	13,0	15,0	15,0	19,0	19,0	27,0	30,0
	K (mm)	1,5	1,5	2,5	7,0	7,0	7,0	8,0	10,0	13,0
	L (mm)	40,2	40,2	50,0	60,0	60,0	75,0	90,0	112,0	130,0
	Ø M (mm)	6,0	6,0	8,0	10,0	10,0	12,0	16,0	20,0	24,0
	P (mm)	35,0	35,0	45,0	55,0	55,0	70,0	70,0	80,0	100,0
	R (mm)	13,0	13,0	18,5	23,5	23,5	34,0	41,0	48,0	62,0
	S (mm)	20,0	20,0	30,0	37,0	37,0	50,0	167,0	200,0	230,0
T (mm)	75,0	75,0	97,0	119,0	119,0	154,0	300,0	360,0	430,0	
□ U (mm)	6,0	6,0	8,0	9,0	9,0	12,0	16,0	19,0	21,0	
Nutzlänge Working length	X (mm)	262,0	325,0	324,0	442,0	542,0	—	—	—	
	Y (mm)	206,0	265,0	264,0	368,0	473,0	475,0	623,0	764,0	946,0
	Z (mm)	234,0	295,0	294,0	405,0	502,5	525,0	698,0	864,0	1064,0
Gewicht je Paar Weight per pair (≈ kg)	1,120	1,300	2,970	6,100	6,500	10,650	16,200	36,100	59,500	
€/Satz set	auf Anfrage / on request									

Vorteile der MS Motorspannschienen

- Sie sind unzerbrechlich, weil sie ganz aus Stahl hergestellt sind.
- Die genormten Motorbefestigungsschrauben sind leicht auswechselbar, z. B. bei starken Motorfüßen oder bei zu befestigenden Zusatzteilen.
- Leichtes Aufsetzen des Motors:
Nach dem Einstecken der Motorbefestigungsschrauben in die Motorfüße wird das Ganze mit den Spezialmuttern in die Stahlspannschienen eingeschoben.
- Alle Einzelteile sind bestens gegen Korrosion durch entsprechende Oberflächenbehandlung geschützt.
- Stahlspannschienen: phosphatiert und grün einbrennlackiert.
- Spannschrauben: elektro-verzinkt.
- Motorbefestigungsschrauben:
für S 71 bis S 180 elektro-verzinkt,
für S 225 bis S 355 phosphatiert und mit Rostschutz versehen.

Die mit „S“ gekennzeichneten Abmessungen (z. B. S 71) entsprechen der französischen Norm U.T.E. C-51106. Die Zahlen 71, 100, 132, 180, 225, 280 und 355 bezeichnen die maximalen Motorachshöhen in mm für den jeweiligen Spannschienen-Typ.

Die Zahlen hinter dem Schrägstrich (6, 8, 10, 12, 16, 20, 24) geben den Gewindedurchmesser der entsprechenden Befestigungsschrauben an (6 = M6).

Die Buchstaben VS bzw. GS bezeichnen die Ausführung der Spannkloben:

- VS = verschiebbarer Spannkloben
- GS = geschweißter Spannkloben

Die Typen N 300, N 400 und N 600 sind nicht genormt. Es handelt sich jeweils um die verlängerte Ausführung der genormten Schiene, sodass hierfür die gleichen Ersatzteile verwendet werden können.

Ein Satz Spannschienen besteht aus 2 Schienen inklusive aller Befestigungsteile.

Advantages of MS motor slide rails

- Rugged all steel construction.
- The standard motor fixing bolts are easily replaced, e. g. for heavier motor feet or for the mounting of auxiliary equipment.
- Easy motor mounting. After inserting the motor mounting bolts into the motor feet, the whole unit is pushed into the rails.
- All parts are fully corrosion protected.
- Steel tension rails: Phosphated and stone-enamelled in green.
- The adjusting bolts are zinc plated.
- The motor mounting bolts:
for S 71 up to S 180 are zinc plated,
for S 225 up to S 355 are phosphated and rust protected.

The sizes marked with "S" (e. g. S 71) correspond to the French standard U.T.E. C-51106.

The numbers 71, 100, 132, 180, 225, 280, and 355 indicate the max. motor shaft height in mm for the individual rail types.

The numbers following the slash (6, 8, 10, 12, 16, 20, 24) indicate the thread diameters of the fixing bolts (6 = M6).

The letters VS and GS indicate the design of the adjusting screw bracket:

- VS = sliding bracket
- GS = fixed bracket

Slide rail part number N 300, N 400, and N 600 are not standardised. They are longer than the standard slide rails but all of the same spare parts can be used.

One set of slide rails consists of 2 rails with all fixing parts.

Motorspannschlitten Motor slide bases

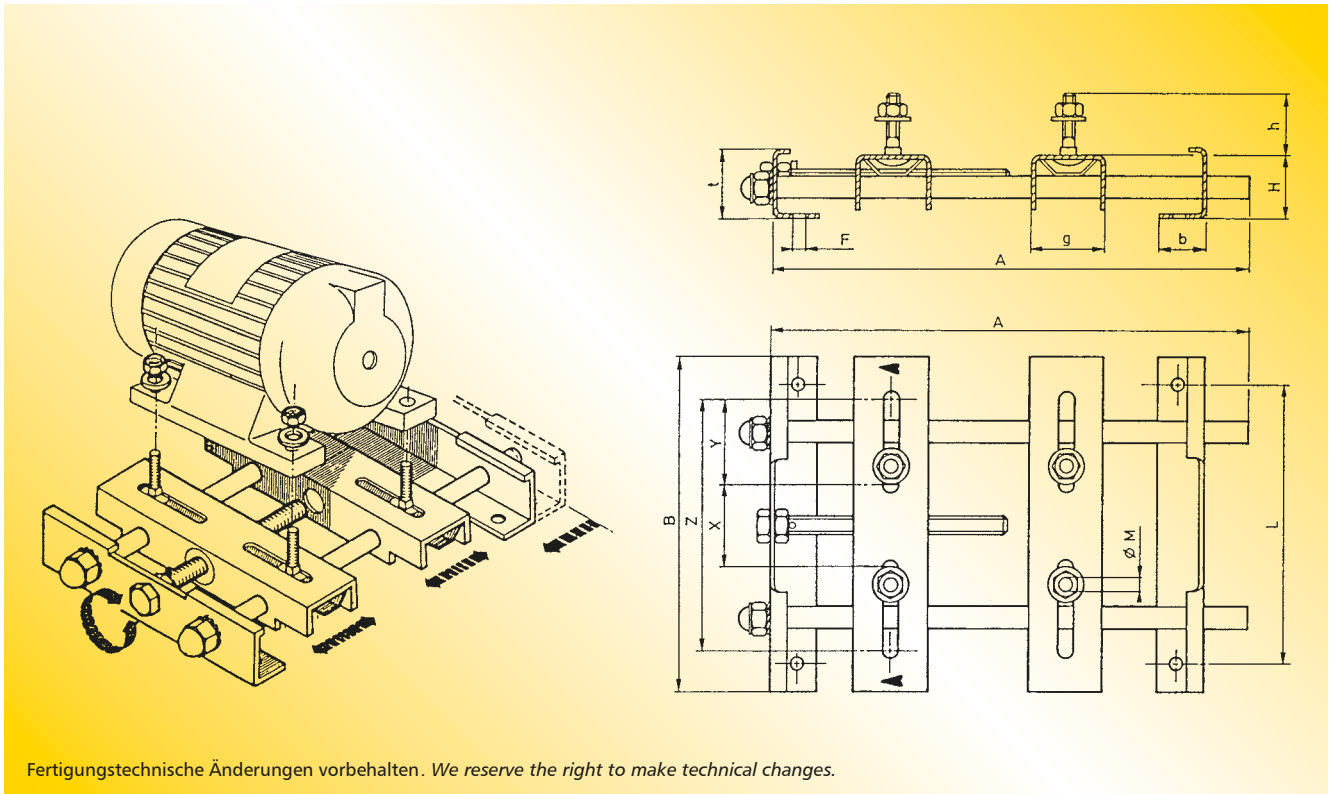

Fertigungstechnische Änderungen vorbehalten. We reserve the right to make technical changes.

Bezeichnung Part number	MS 100	MS 132
Motorachshöhe Motor shaft centre height Ha (mm)	100,0	132,0
A (mm)	300,0	450,0
B (mm)	180,0	265,0
F (mm)	10,0	13,0
H (mm)	35,0	50,0
L (mm)	150,0	225,0
M	M 8 x 35	M 10 x 40
b (mm)	30,0	45,0
g (mm)	40,0	55,0
h (mm)	35,0	40,0
t (mm)	40,0	55,0
u (mm)	25,0	35,0
v (mm)	20,0	25,0
w (mm)	9,0	18,0
x (mm)	46,0	105,0
y (mm)	50,0	50,0
z (mm)	145,0	204,0
Gewicht Weight (≈ kg)	2,180	4,520
€/Stück each	auf Anfrage / on request	

Standard-Zahnscheiben für zylindrische Bohrung

Timing belt pulleys for plain boring

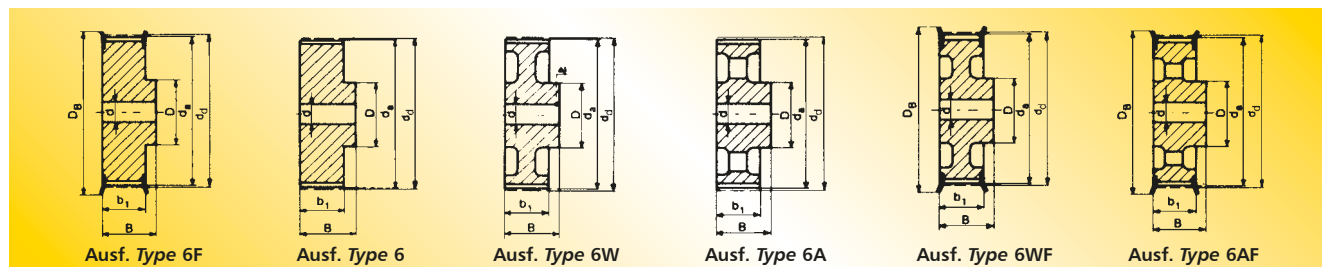

Type XL – Teilung Pitch 5,08 mm für Riemenbreite for belt width 025, 031, 037

Bezeichnung Part No.	Anzahl der Zähne No. of teeth	Aus- führung Type	Material	d _d (mm)	d _s (mm)	D _B (mm)	b ₁ (mm)	B (mm)	D (mm)	Vor- bohrung Pilot bore d (mm)	Fertig- bohrung Finished bore d _{max} (mm)	Gewicht Weight (≈ kg)	€ Stück each
10 XL 037	10	6F	St	16,17	15,66	23	14,3	19,8	9,5	5,0	6,4	0,02	auf Anfrage on request
11 XL 037	11	6F	St	17,79	17,28	23	14,3	19,8	9,5	5,0	6,4	0,02	
12 XL 037	12	6F	St	19,40	18,89	25	14,3	19,8	12,7	5,0	7,9	0,03	
14 XL 037	14	6F	St	22,64	22,13	28	14,3	19,8	14,3	6,0	9,5	0,04	
15 XL 037	15	6F	St	24,26	23,75	28	14,3	19,8	15,9	6,0	11,1	0,04	
16 XL 037	16	6F	St	25,87	25,36	32	14,3	19,8	17,5	6,0	12,7	0,05	
18 XL 037	18	6F	St	29,11	28,60	36	14,3	19,8	19,0	6,0	14,3	0,06	
20 XL 037	20	6F	St	32,34	31,83	38	14,3	22,2	23,8	6,0	17,5	0,08	
21 XL 037	21	6F	St	33,96	33,45	38	14,3	22,2	23,8	6,0	17,5	0,09	
22 XL 037	22	6F	St	35,57	35,06	42	14,3	22,2	25,4	6,0	19,1	0,10	
24 XL 037	24	6F	St	38,81	38,30	44	14,3	22,2	27,0	6,0	20,6	0,12	
26 XL 037	26	6F	St	42,04	41,53	48	14,3	22,2	30,0	6,0	23,0	0,14	
28 XL 037	28	6F	St	45,28	44,77	51	14,3	22,2	30,2	6,0	23,0	0,16	
30 XL 037	30	6F	St	48,51	48,00	54	14,3	22,2	34,9	6,0	23,0	0,19	
32 XL 037	32	6	Al	51,74	51,23	—	14,3	25,4	38,0	8,0	23,0	0,11	
36 XL 037	36	6	Al	58,21	57,70	—	14,3	25,4	38,0	8,0	23,0	0,13	
40 XL 037	40	6	Al	64,68	64,17	—	14,3	25,4	38,0	8,0	23,0	0,17	
42 XL 037	42	6WF	Al	67,91	67,40	—	14,3	25,4	38,0	8,0	23,0	0,13	
44 XL 037	44	6WF	Al	71,15	70,64	—	14,3	25,4	38,0	8,0	23,0	0,15	
48 XL 037	48	6WF	Al	77,62	77,11	—	14,3	25,4	38,0	8,0	23,0	0,16	
60 XL 037	60	6A	Al	97,02	96,51	—	14,3	25,4	38,0	8,0	23,0	0,18	
72 XL 037	72	6A	Al	116,43	115,92	—	14,3	25,4	38,0	8,0	23,0	0,23	

Type L – Teilung Pitch 9,525 mm für Riemenbreite for belt width 050

10 L 050	10	6F	St	30,32	29,56	36	19	26	22	6,0	13,0	0,11	auf Anfrage on request
12 L 050	12	6F	St	36,38	35,62	42	19	26	28	6,0	17,0	0,19	
13 L 050	13	6F	St	39,41	38,65	44	19	26	28	6,0	19,0	0,21	
14 L 050	14	6F	St	42,45	41,68	48	19	26	33	8,0	20,0	0,25	
15 L 050	15	6F	St	45,48	44,72	51	19	26	36	8,0	23,0	0,30	
16 L 050	16	6F	St	48,51	47,75	54	19	26	38	8,0	23,0	0,33	
17 L 050	17	6F	St	51,54	50,78	57	19	26	40	10,0	24,0	0,36	
18 L 050	18	6F	St	54,57	53,81	60	19	26	40	10,0	24,0	0,41	
19 L 050	19	6F	St	57,61	56,84	60	19	26	40	10,0	24,0	0,45	
20 L 050	20	6F	St	60,64	59,88	66	19	26	46	10,0	28,0	0,50	
21 L 050	21	6F	St	63,67	62,91	71	19	26	46	10,0	28,0	0,55	
22 L 050	22	6F	St	66,70	65,94	75	19	26	50	10,0	30,0	0,62	
24 L 050	24	6F	St	72,77	72,00	79	19	26	50	12,0	30,0	0,68	
26 L 050	26	6F	St	78,83	78,07	87	19	26	50	12,0	30,0	0,82	
28 L 050	28	6F	St	84,89	84,13	91	19	26	50	12,0	30,0	0,92	
30 L 050	30	6F	St	90,96	90,20	97	19	26	50	12,0	30,0	1,10	
32 L 050	32	6F	St	97,02	96,26	103	19	26	50	12,0	30,0	1,20	
36 L 050	36	6WF	GG	109,15	108,38	115	19	26	50	12,0	30,0	1,00	
40 L 050	40	6WF	GG	121,28	120,51	127	19	26	50	12,0	30,0	1,10	
44 L 050	44	6AF	GG	133,40	132,64	140	19	26	50	12,0	30,0	1,20	
48 L 050	48	6AF	GG	145,53	144,77	152	19	26	50	12,0	30,0	1,30	
60 L 050	60	6A	GG	181,91	181,15	—	19	28	50	15,0	30,0	1,30	
72 L 050	72	6A	GG	218,30	217,53	—	19	28	50	15,0	30,0	1,70	
84 L 050	84	6A	GG	254,68	253,92	—	19	28	50	15,0	30,0	1,90	

St = Stahl Steel Al = Aluminium GG = Grauguss Cast iron

Fertigungstechnische Änderungen vorbehalten. We reserve the right to make technical changes.

Standard-Zahnscheiben für zylindrische Bohrung Timing belt pulleys for plain boring

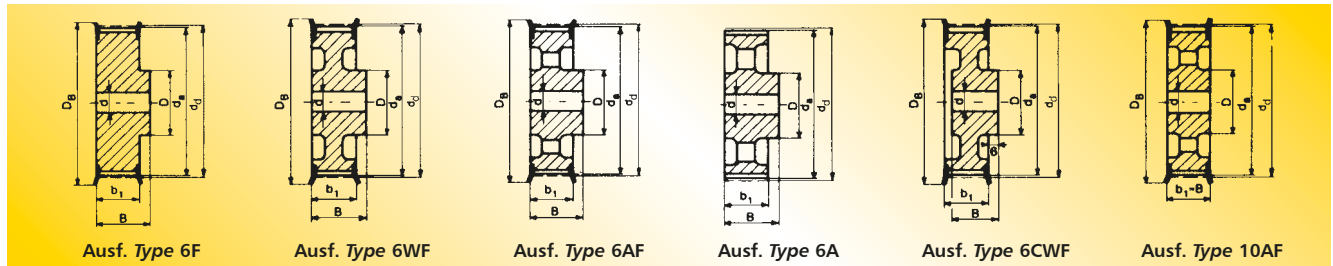

Type L – Teilung Pitch 9,525 mm für Riemenbreite for belt width 075

Bezeichnung Part No.	Anzahl der Zähne No. of teeth	Aus- führung Type	Material	d _d (mm)	d _s (mm)	D _B (mm)	b ₁ (mm)	B (mm)	D (mm)	Vor- bohrung Pilot bore d (mm)	Fertig- bohrung Finished bore d _{max} (mm)	Gewicht Weight (≈ kg)	€ Stück each
10 L 075	10	6F	St	30,32	29,56	36	25	32	22	6	13	0,15	auf Anfrage on request
12 L 075	12	6F	St	36,38	35,62	42	25	32	28	8	17	0,23	
13 L 075	13	6F	St	39,41	38,65	44	25	32	30	8	19	0,26	
14 L 075	14	6F	St	42,45	41,68	48	25	32	33	8	20	0,32	
15 L 075	15	6F	St	45,48	44,72	51	25	32	36	8	23	0,35	
16 L 075	16	6F	St	48,51	47,75	54	25	32	38	8	23	0,42	
17 L 075	17	6F	St	51,54	50,78	57	25	32	40	10	24	0,45	
18 L 075	18	6F	St	54,57	53,81	60	25	32	40	10	24	0,51	
19 L 075	19	6F	St	57,61	56,84	60	25	32	40	10	24	0,57	
20 L 075	20	6F	St	60,64	59,88	66	25	32	46	10	28	0,63	
21 L 075	21	6F	St	63,67	62,91	71	25	32	46	10	28	0,70	
22 L 075	22	6F	St	66,70	65,94	75	25	32	50	10	30	0,75	
24 L 075	24	6F	St	72,77	72,00	79	25	32	50	12	30	0,85	
26 L 075	26	6F	St	78,83	78,07	87	25	32	50	12	30	1,00	
28 L 075	28	6F	St	84,89	84,13	91	25	32	50	12	30	1,20	
30 L 075	30	6F	St	90,96	90,20	97	25	32	50	12	30	1,40	
32 L 075	32	6F	St	97,02	96,26	103	25	32	50	12	30	1,50	
36 L 075	36	6WF	GG	109,15	108,38	115	25	32	55	12	32	1,30	
40 L 075	40	6WF	GG	121,28	120,51	127	25	32	60	12	35	1,60	
44 L 075	44	6AF	GG	133,40	132,64	140	25	32	60	12	35	1,70	
48 L 075	48	6AF	GG	145,53	144,77	152	25	32	60	12	35	1,90	
60 L 075	60	6A	GG	181,91	181,15	—	26	35	60	15	35	1,80	
72 L 075	72	6A	GG	218,30	217,53	—	26	35	60	15	35	2,30	
84 L 075	84	6A	GG	254,68	253,92	—	26	35	60	15	35	2,50	

Type L – Teilung Pitch 9,525 mm für Riemenbreite for belt width 100

10 L 100	10	6F	St	30,32	29,56	36	31	38	22	6	13	0,81	auf Anfrage on request
12 L 100	12	6F	St	36,38	35,62	42	31	38	28	8	17	0,29	
13 L 100	13	6F	St	39,41	38,65	44	31	38	28	8	19	0,30	
14 L 100	14	6F	St	42,45	41,68	48	31	38	33	8	20	0,38	
15 L 100	15	6F	St	45,48	44,72	51	31	38	36	8	23	0,40	
16 L 100	16	6F	St	48,51	47,75	54	31	38	38	8	23	0,51	
17 L 100	17	6F	St	51,54	50,78	57	31	38	40	10	24	0,54	
18 L 100	18	6F	St	54,57	53,81	60	31	38	40	10	24	0,62	
19 L 100	19	6F	St	57,61	56,84	60	31	38	40	10	24	0,69	
20 L 100	20	6F	St	60,64	59,88	66	31	38	46	10	28	0,76	
21 L 100	21	6F	St	63,67	62,91	71	31	38	46	10	28	0,82	
22 L 100	22	6F	St	66,70	65,94	75	31	38	50	10	30	0,92	
24 L 100	24	6F	St	72,77	72,00	79	31	38	50	12	30	1,10	
26 L 100	26	6F	St	78,83	78,07	87	31	38	50	12	30	1,30	
28 L 100	28	6F	St	84,89	84,13	91	31	38	50	12	30	1,40	
30 L 100	30	6F	St	90,96	90,20	97	31	38	50	12	30	1,70	
32 L 100	32	6F	St	97,02	96,26	103	31	38	50	12	30	1,80	
36 L 100	36	6CWF	GG	109,15	108,38	115	32	32	55	12	32	1,50	
40 L 100	40	6CWF	GG	121,28	120,51	127	32	32	60	12	35	1,80	
44 L 100	44	10AF	GG	133,40	132,64	140	32	32	60	12	35	1,90	
48 L 100	48	10AF	GG	145,53	144,77	152	32	32	60	12	35	2,10	
60 L 100	60	6A	GG	181,91	181,15	—	32	35	60	15	35	2,00	
72 L 100	72	6A	GG	218,30	217,53	—	32	35	60	15	35	2,50	
84 L 100	84	6A	GG	254,68	253,92	—	32	35	60	15	35	2,70	

St = Stahl Steel GG = Grauguss Cast iron

Fertigungstechnische Änderungen vorbehalten. We reserve the right to make technical changes.

Standard-Zahnscheiben für zylindrische Bohrung

Timing belt pulleys for plain boring

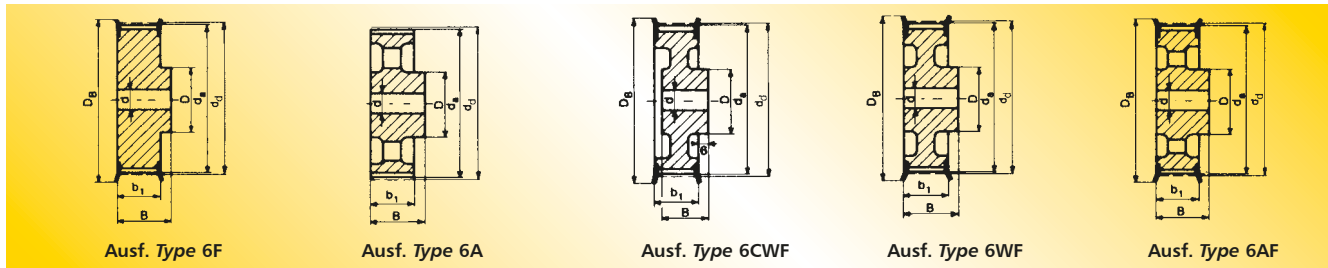

Type H – Teilung *Pitch* 12,7 mm für Riemenbreite *for belt width* 075

Bezeichnung Part No.	Anzahl der Zähne No. of teeth	Aus- führung Type	Material	d_d (mm)	d_a (mm)	D_B (mm)	b_1 (mm)	B (mm)	D (mm)	Vor- bohrung Pilot bore d (mm)	Fertig- bohrung Finished bore d_{max} (mm)	Gewicht Weight (≈ kg)	€ Stück each
14 H 075	14	6F	St	56,60	55,22	64,0	26,4	40	40	10	24	0,50	auf Anfrage on request
16 H 075	16	6F	St	64,67	63,31	70,0	26,4	40	46	10	26	0,60	
18 H 075	18	6F	St	72,77	71,39	79,0	26,4	40	54	12	32	0,80	
19 H 075	19	6F	St	76,81	75,44	82,5	26,4	40	58	12	35	1,00	
20 H 075	20	6F	St	80,85	79,48	87,0	26,4	40	62	12	35	1,10	
21 H 075	21	6F	St	84,89	83,52	91,0	26,4	40	67	12	38	1,20	
22 H 075	22	6F	St	88,94	87,56	94,0	26,4	40	70	12	38	1,40	
24 H 075	24	6F	St	97,02	95,65	102,0	26,4	40	75	12	42	1,60	
26 H 075	26	6F	St	105,11	103,73	112,0	26,4	40	80	15	45	1,80	
28 H 075	28	6F	GG	113,19	111,82	120,0	26,4	40	80	15	45	2,00	
30 H 075	30	6F	GG	121,28	119,90	128,0	26,4	40	80	15	45	2,10	
32 H 075	32	6F	GG	129,36	127,99	135,0	26,4	40	70	15	45	2,20	
36 H 075	36	6F	GG	145,53	144,16	152,0	26,4	40	80	20	45	2,40	
40 H 075	40	6F	GG	161,70	160,33	168,0	26,4	40	80	20	45	2,80	
44 H 075	44	6AF	GG	177,87	176,50	184,0	26,4	40	80	20	45	2,70	
48 H 075	48	6AF	GG	194,04	192,67	200,0	26,4	40	90	20	50	3,00	

Type H – Teilung *Pitch* 12,7 mm für Riemenbreite *for belt width* 100

14 H 100	14	6F	St	56,60	55,22	63	31	41	40	10	24	0,65	auf Anfrage on request
16 H 100	16	6F	St	64,68	63,31	71	31	41	46	10	28	0,85	
18 H 100	18	6F	St	72,77	71,39	79	31	41	54	12	32	1,10	
19 H 100	19	6F	St	76,81	75,44	83	31	41	58	12	34	1,20	
20 H 100	20	6F	St	80,85	79,48	87	31	41	62	12	35	1,40	
21 H 100	21	6F	St	84,89	83,52	91	31	41	67	12	38	1,60	
22 H 100	22	6F	St	88,94	87,56	93	31	41	70	12	41	1,70	
24 H 100	24	6F	St	97,02	95,65	103	31	41	75	12	45	2,00	
26 H 100	26	6CWF	GG	105,11	103,73	111	32	32	55	15	32	1,40	
28 H 100	28	6CWF	GG	113,19	111,82	119	32	32	60	15	35	1,60	
30 H 100	30	6CWF	GG	121,28	119,90	127	32	32	60	15	35	1,70	
32 H 100	32	6WF	GG	129,36	127,99	135	32	40	70	20	40	2,20	
36 H 100	36	6WF	GG	145,53	144,16	152	32	40	80	20	45	3,00	
40 H 100	40	6AF	GG	161,70	160,33	168	32	40	80	20	45	2,80	
44 H 100	44	6AF	GG	177,87	176,50	184	32	40	80	20	45	3,10	
48 H 100	48	6AF	GG	194,04	192,67	200	32	40	80	20	45	3,30	
60 H 100	60	6A	GG	242,55	241,18	—	34	45	80	20	45	5,50	
72 H 100	72	6A	GG	291,06	289,69	—	34	45	80	20	45	7,10	
84 H 100	84	6A	GG	339,57	338,20	—	34	45	80	20	45	8,20	
96 H 100	96	6A	GG	388,08	386,71	—	34	45	80	20	45	9,90	
120 H 100	120	6A	GG	485,10	483,73	—	34	50	90	20	50	13,10	

St = Stahl Steel GG = Grauguss Cast iron

Fertigungstechnische Änderungen vorbehalten. We reserve the right to make technical changes.

Standard-Zahnscheiben für zylindrische Bohrung Timing belt pulleys for plain boring

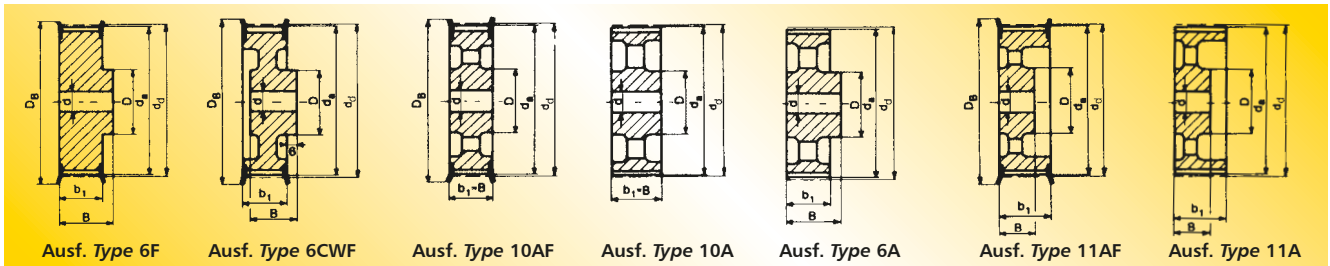

Type H – Teilung Pitch 12,7 mm für Riemenbreite for belt width 150

Bezeichnung Part No.	Anzahl der Zähne No. of teeth	Aus- führung Type	Material	d _d (mm)	d _s (mm)	D _B (mm)	b ₁ (mm)	B (mm)	D (mm)	Vor- bohrung Pilot bore d (mm)	Fertig- bohrung Finished bore d _{max} (mm)	Gewicht Weight (≈ kg)	€ Stück each
14 H 150	14	6F	St	56,60	55,22	63	44	54	40	12	24	0,82	auf Anfrage on request
16 H 150	16	6F	St	64,68	63,31	71	44	54	46	12	28	1,10	
18 H 150	18	6F	St	72,77	71,39	79	44	54	54	12	32	1,50	
19 H 150	19	6F	St	76,81	75,44	83	44	54	58	12	34	1,70	
20 H 150	20	6F	St	80,85	79,48	87	44	54	62	12	35	1,80	
21 H 150	21	6F	St	84,89	83,52	91	44	54	67	12	38	2,20	
22 H 150	22	6F	St	88,94	87,56	93	44	54	70	12	41	2,30	
24 H 150	24	6F	St	97,02	95,65	103	44	54	75	12	45	2,60	
26 H 150	26	6CWF	GG	105,11	103,73	111	45	35	55	15	32	1,70	
28 H 150	28	6CWF	GG	113,19	111,82	119	45	35	60	15	35	1,90	
30 H 150	30	6CWF	GG	121,28	119,90	127	45	35	60	15	35	2,10	
32 H 150	32	6CWF	GG	129,36	127,99	135	45	45	70	20	40	2,60	
36 H 150	36	6CWF	GG	145,53	144,16	152	45	45	80	20	45	3,20	
40 H 150	40	10AF	GG	161,70	160,33	168	45	45	80	20	45	3,80	
44 H 150	44	10AF	GG	177,87	176,50	184	45	45	80	20	45	3,70	
48 H 150	48	10AF	GG	194,04	192,67	200	45	45	80	20	45	4,00	
60 H 150	60	10A	GG	242,55	241,18	—	46	46	85	20	48	5,10	
72 H 150	72	10A	GG	291,06	289,69	—	46	46	85	20	48	7,90	
84 H 150	84	10A	GG	339,57	338,20	—	46	46	85	20	48	8,90	
96 H 150	96	10A	GG	388,08	386,71	—	46	46	85	20	48	10,10	
120 H 150	120	6A	GG	485,10	483,73	—	46	55	95	24	55	17,20	

Type H – Teilung Pitch 12,7 mm für Riemenbreite for belt width 200

14 H 200	14	6F	St	56,60	55,22	63	58	68	40	12	24	1,1	auf Anfrage on request
16 H 200	16	6F	St	64,68	63,31	71	58	68	46	15	28	1,4	
18 H 200	18	6F	St	72,77	71,39	79	58	68	54	15	32	1,8	
19 H 200	19	6F	St	76,81	75,44	83	58	68	58	15	34	2,1	
20 H 200	20	6F	St	80,85	79,48	87	58	68	62	15	35	2,3	
21 H 200	21	6F	St	84,89	83,52	91	58	68	67	15	38	2,6	
22 H 200	22	6F	St	88,94	87,56	93	58	68	70	15	41	2,8	
24 H 200	24	6F	St	97,02	95,65	103	58	68	75	15	45	3,4	
26 H 200	26	6CWF	GG	105,11	103,73	111	58	42	60	15	35	2,3	
28 H 200	28	6CWF	GG	113,19	111,82	119	58	42	60	15	35	2,5	
30 H 200	30	6CWF	GG	121,28	119,90	127	58	42	70	15	40	2,9	
32 H 200	32	6CWF	GG	129,36	127,99	135	58	47	70	20	40	3,2	
36 H 200	36	6CWF	GG	145,53	144,16	152	58	47	80	20	45	3,8	
40 H 200	40	11AF	GG	161,70	160,33	168	58	45	80	20	45	4,1	
44 H 200	44	11AF	GG	177,87	176,50	184	58	45	80	20	45	4,4	
48 H 200	48	11AF	GG	194,04	192,67	200	58	45	85	20	48	5,1	
60 H 200	60	11A	GG	242,55	241,18	—	60	50	90	20	50	7,1	
72 H 200	72	11A	GG	291,06	289,69	—	60	50	90	20	50	8,0	
84 H 200	84	11A	GG	339,57	338,20	—	60	50	90	20	50	12,0	
96 H 200	96	11A	GG	388,08	386,71	—	60	50	90	20	50	13,6	
120 H 200	120	10A	GG	485,10	483,73	—	60	60	100	24	57	16,6	

Standard-Zahnscheiben für zylindrische Bohrung Timing belt pulleys for plain boring

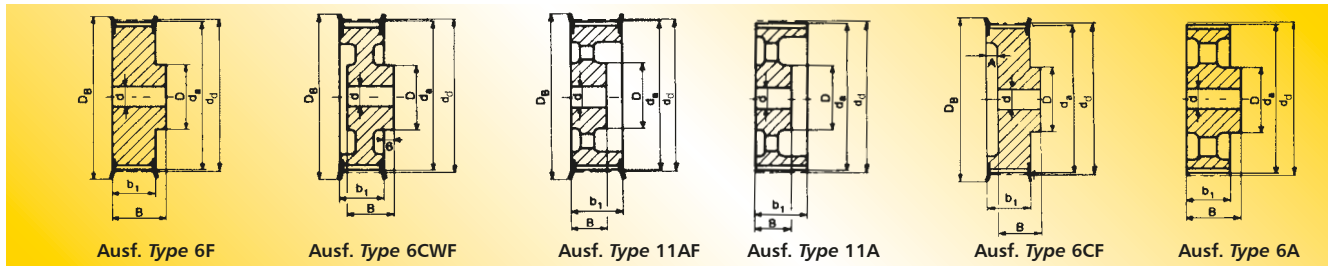

Type H – Teilung *Pitch 12,7 mm* für Riemenbreite *for belt width 300*

Bezeichnung Part No.	Anzahl der Zähne No. of teeth	Aus- führung Type	Material	d _d (mm)	d _s (mm)	D _B (mm)	b ₁ (mm)	B (mm)	D (mm)	A (mm)	Vor- bohrung Pilot bore d (mm)	Fertig- bohrung Finished bore d _{max} (mm)	Gewicht Weight (≈ kg)	€ Stück each
16 H 300	16	6F	St	64,68	63,31	71	84	94	46	—	15	28	2,0	auf Anfrage on request
18 H 300	18	6F	St	72,77	71,39	79	84	94	54	—	15	32	2,6	
19 H 300	19	6F	St	76,81	75,44	83	84	94	58	—	15	34	2,9	
20 H 300	20	6F	St	80,85	79,48	87	84	94	62	—	15	35	3,2	
21 H 300	21	6F	St	84,89	83,52	91	84	94	67	—	15	38	3,6	
22 H 300	22	6F	St	88,94	87,56	93	84	94	70	—	15	41	4,0	
24 H 300	24	6F	St	97,02	95,65	103	84	94	75	—	15	45	4,7	
26 H 300	26	6CWF	GG	105,11	103,73	111	84	57	60	—	15	35	3,3	
28 H 300	28	6CWF	GG	113,19	111,82	119	84	57	60	—	15	35	3,6	
30 H 300	30	6CWF	GG	121,28	119,90	127	84	57	70	—	15	40	4,2	
32 H 300	32	6CWF	GG	129,36	127,99	135	84	57	70	—	20	40	4,3	
36 H 300	36	6CWF	GG	145,53	144,16	152	84	57	80	—	20	45	5,2	
40 H 300	40	11AF	GG	161,70	160,33	168	84	55	80	—	20	45	5,6	
44 H 300	44	11AF	GG	177,87	176,50	184	84	55	80	—	20	45	5,9	
48 H 300	48	11AF	GG	194,04	192,67	200	84	55	85	—	20	48	6,6	
60 H 300	60	11A	GG	242,55	241,18	—	86	55	100	—	20	57	9,9	
72 H 300	72	11A	GG	291,06	289,69	—	86	55	100	—	20	57	13,0	
84 H 300	84	11A	GG	339,57	338,20	—	86	55	100	—	20	57	15,1	
96 H 300	96	11A	GG	388,08	386,71	—	86	55	100	—	20	57	18,2	
120 H 300	120	11A	GG	485,10	483,73	—	86	65	110	—	24	62	26,0	

Type XH – Teilung *Pitch 22,225 mm* für Riemenbreite *for belt width 200*

18 XH 200	18	6CF	GG	127,34	124,55	142	64,4	60	85	18	20	50	5,0	auf Anfrage on request
20 XH 200	20	6CF	GG	141,49	138,69	155	64,4	60	95	18	20	55	6,0	
22 XH 200	22	6CF	GG	155,64	152,84	170	64,4	60	110	18	20	65	7,2	
24 XH 200	24	6CF	GG	169,79	166,69	184	64,4	60	125	18	25	70	8,6	
26 XH 200	26	6CF	GG	183,94	181,14	198	64,4	60	140	18	25	80	10,1	
28 XH 200	28	6CWF	GG	198,08	195,29	212	64,4	60	120	18	25	70	9,6	
30 XH 200	30	6CWF	GG	212,23	209,44	227	64,4	60	120	18	25	70	10,4	
32 XH 200	32	6CWF	GG	226,38	223,59	240	64,4	60	130	18	25	75	11,2	
40 XH 200	40	6CWF	GG	282,98	280,18	297	64,4	60	140	18	25	80	16,0	
48 XH 200	48	6A	GG	339,57	336,78	—	65,0	80	150	—	30	85	18,4	
60 XH 200	60	6A	GG	424,47	421,67	—	65,0	80	150	—	30	85	24,3	
72 XH 200	72	6A	GG	509,36	506,57	—	65,0	80	150	—	40	85	28,1	
84 XH 200	84	6A	GG	594,25	591,46	—	65,0	80	160	—	40	90	31,9	
96 XH 200	96	6A	GG	679,15	676,35	—	65,0	80	160	—	40	90	37,0	

St = Stahl Steel GG = Grauguss Cast iron

Fertigungstechnische Änderungen vorbehalten. We reserve the right to make technical changes.

Standard-Zahnscheiben für zylindrische Bohrung Timing belt pulleys for plain boring

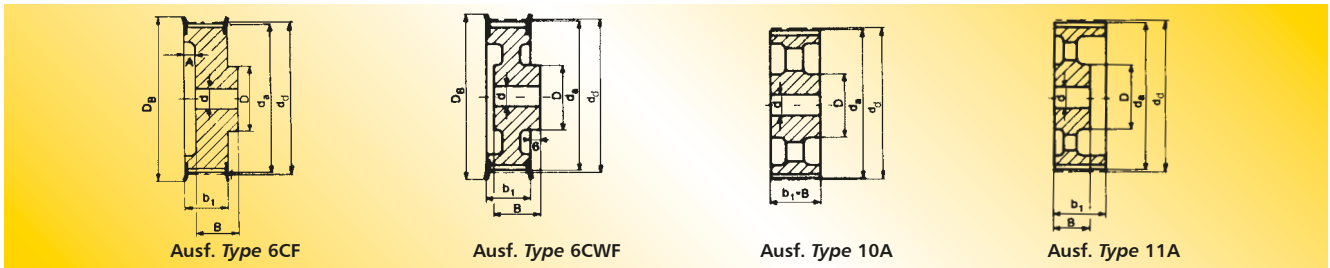

Type XH – Teilung Pitch 22,225 mm für Riemenbreite for belt width 300

Bezeichnung Part No.	Anzahl der Zähne No. of teeth	Aus- führung Type	Material	d _d (mm)	d _s (mm)	D _B (mm)	b ₁ (mm)	B (mm)	D (mm)	A (mm)	Vor- bohrung Pilot bore d (mm)	Fertig- bohrung Finished bore d _{max} (mm)	Gewicht Weight (≈ kg)	€ Stück each
18 XH 300	18	6CF	GG	127,34	124,55	142	91,4	70	85	35	20	50	6,8	auf Anfrage on request
20 XH 300	20	6CF	GG	141,49	138,69	155	91,4	70	95	35	20	55	7,4	
22 XH 300	22	6CF	GG	155,64	152,84	170	91,4	70	110	35	20	65	9,0	
24 XH 300	24	6CF	GG	169,79	166,69	184	91,4	70	125	35	25	70	10,6	
26 XH 300	26	6CF	GG	183,94	181,14	198	91,4	70	140	35	25	80	13,0	
28 XH 300	28	6CWF	GG	198,08	195,29	212	91,4	70	120	35	25	70	12,0	
30 XH 300	30	6CWF	GG	212,23	209,44	227	91,4	70	120	35	25	70	13,0	
32 XH 300	32	6CWF	GG	226,38	223,59	240	91,4	70	130	35	25	75	14,7	
40 XH 300	40	6CWF	GG	282,98	280,18	297	91,4	70	140	35	25	80	19,9	
48 XH 300	48	10A	GG	339,57	336,78	—	92,0	92	150	—	30	85	22,5	
60 XH 300	60	10A	GG	424,47	421,67	—	92,0	92	150	—	30	85	31,5	
72 XH 300	72	10A	GG	509,36	506,57	—	92,0	92	150	—	40	85	36,4	
84 XH 300	84	10A	GG	594,25	591,46	—	92,0	92	160	—	40	90	43,4	
96 XH 300	96	10A	GG	679,15	676,35	—	92,0	92	160	—	40	90	48,5	

Type XH – Teilung Pitch 22,225 mm für Riemenbreite for belt width 400

18 XH 400	18	6CF	GG	127,34	124,55	142	118,4	85	85	47	20	50	8,5	auf Anfrage on request
20 XH 400	20	6CF	GG	141,49	138,69	155	118,4	85	95	47	20	55	9,4	
22 XH 400	22	6CF	GG	155,64	152,84	170	118,4	85	110	47	20	65	11,5	
24 XH 400	24	6CF	GG	169,79	166,69	184	118,4	85	125	47	25	70	13,4	
26 XH 400	26	6CF	GG	183,94	181,14	198	118,4	85	140	47	25	80	15,6	
28 XH 400	28	6CWF	GG	198,08	195,29	212	118,4	85	120	47	25	70	14,5	
30 XH 400	30	6CWF	GG	212,23	209,44	227	118,4	85	120	47	25	70	16,0	
32 XH 400	32	6CWF	GG	226,38	223,59	240	118,4	85	130	47	25	75	18,0	
40 XH 400	40	6CWF	GG	282,98	280,18	297	118,4	85	140	47	25	80	24,0	
48 XH 400	48	11A	GG	339,57	336,78	—	119,0	92	150	—	30	85	30,8	
60 XH 400	60	11A	GG	424,47	421,67	—	119,0	92	150	—	30	85	36,2	
72 XH 400	72	11A	GG	509,36	506,57	—	119,0	92	150	—	40	85	42,7	
84 XH 400	84	11A	GG	594,25	591,46	—	119,0	92	160	—	40	90	49,7	
96 XH 400	96	11A	GG	679,15	676,35	—	119,0	92	160	—	40	90	59,9	

Standard-Zahnscheiben für Taperbuchsen

Timing belt pulleys for taper bushes

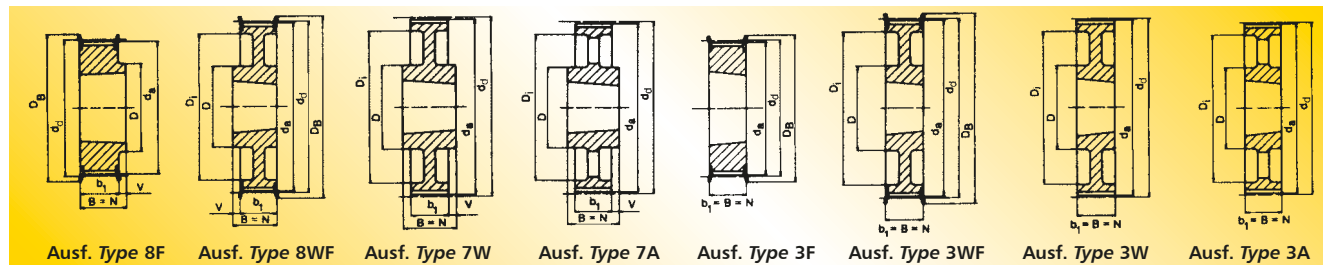

Type L – Teilung Pitch 9,525 mm für Riemenbreite for belt width 050

Bezeichnung Part No.	Anzahl der Zähne No. of teeth	Aus- führung Type	Material	d _d (mm)	d _s (mm)	D _B (mm)	b ₁ (mm)	B (mm)	N (mm)	V (mm)	Z (mm)	D (mm)	D _i (mm)	Taper- Buchse Taper bush	Gewicht ohne Buchse Weight without bush (≈ kg)	€ Stück ohne Buchse each without bush
TB 18 L 050	18	8F	St	54,57	53,81	60	19,0	22,0	22,0	3,0	—	44	—	1108	0,2	auf Anfrage on request
TB 19 L 050	19	8F	St	57,61	56,84	60	19,0	22,0	22,0	3,0	—	44	—	1108	0,2	
TB 20 L 050	20	8F	St	60,64	59,88	66	19,0	22,0	22,0	3,0	—	48	—	1108	0,2	
TB 21 L 050	21	8F	St	63,67	62,91	71	19,0	22,0	22,0	3,0	—	48	—	1108	0,3	
TB 22 L 050	22	8F	St	66,70	65,94	75	19,0	22,0	22,0	3,0	—	51	—	1108	0,3	
TB 23 L 050	23	8F	GG	69,73	68,97	79	19,0	22,0	22,0	3,0	—	54	—	1108	0,4	
TB 24 L 050	24	8F	GG	72,77	72,00	79	19,0	22,0	22,0	3,0	—	54	—	1108	0,4	
TB 25 L 050	25	8F	GG	75,80	75,04	83	19,0	22,0	22,0	3,0	—	56	—	1108	0,5	
TB 26 L 050	26	8F	GG	78,83	78,07	87	19,0	22,0	22,0	3,0	—	60	—	1108	0,5	
TB 27 L 050	27	8F	GG	81,86	81,10	87	19,0	22,0	22,0	3,0	—	65	—	1108	0,6	
TB 28 L 050	28	8F	GG	84,89	84,13	91	19,0	22,0	22,0	3,0	—	65	—	1108	0,6	
TB 30 L 050	30	8F	GG	90,96	90,20	97	19,0	22,0	22,0	3,0	—	70	—	1108	0,8	
TB 32 L 050	32	8F	GG	97,02	96,26	103	19,0	22,0	22,0	3,0	—	74	—	1108	0,9	
TB 36 L 050	36	8F	GG	109,15	108,39	115	19,0	22,0	22,0	3,0	—	87	—	1108	1,2	
TB 40 L 050	40	8F	GG	121,28	120,51	127	19,0	25,0	25,0	6,0	—	97	—	1610	1,5	
TB 48 L 050	48	8WF	GG	145,53	144,77	152	19,0	25,0	25,0	6,0	—	88	124	1610	2,3	
TB 60 L 050	60	7W	GG	181,91	181,15	—	19,0	25,0	25,0	3,0	—	92	166	1610	2,0	
TB 72 L 050	72	7A	GG	218,30	217,53	—	19,0	25,0	25,0	3,0	—	92	202	1610	3,0	
TB 84 L 050	84	7A	GG	254,68	253,90	—	19,0	25,0	25,0	3,0	—	92	236	1610	4,0	
TB 96 L 050	96	7A	GG	291,06	290,30	—	19,0	32,0	32,0	6,5	—	106	270	2012	5,5	
TB 120 L 050	120	7A	GG	363,83	363,07	—	19,0	32,0	32,0	6,5	—	106	343	2012	6,8	

Type L – Teilung Pitch 9,525 mm für Riemenbreite for belt width 075

TB 18 L 075	18	3F	St	54,57	53,81	60	25,0	25,0	25,0	—	—	—	—	1108	0,2	auf Anfrage on request
TB 19 L 075	19	3F	St	57,61	56,84	60	25,0	25,0	25,0	—	—	—	—	1108	0,3	
TB 20 L 075	20	3F	St	60,64	59,88	66	25,0	25,0	25,0	—	—	—	—	1108	0,3	
TB 21 L 075	21	3F	St	63,67	62,91	71	25,0	25,0	25,0	—	—	—	—	1108	0,4	
TB 22 L 075	22	3F	St	66,70	65,94	75	25,0	25,0	25,0	—	—	—	—	1108	0,4	
TB 23 L 075	23	3F	GG	69,73	68,97	79	25,0	25,0	25,0	—	—	—	—	1108	0,4	
TB 24 L 075	24	3F	GG	72,77	72,00	79	25,0	25,0	25,0	—	—	—	—	1108	0,5	
TB 25 L 075	25	3F	GG	75,80	75,04	83	25,0	25,0	25,0	—	—	—	—	1108	0,6	
TB 26 L 075	26	3F	GG	78,83	78,07	87	25,0	25,0	25,0	—	—	—	—	1108	0,6	
TB 27 L 075	27	3F	GG	81,86	81,10	87	25,0	25,0	25,0	—	—	—	—	1108	0,7	
TB 28 L 075	28	3F	GG	84,89	84,13	91	25,0	25,0	25,0	—	—	—	—	1108	0,7	
TB 30 L 075	30	3F	GG	90,96	90,20	97	25,0	25,0	25,0	—	—	—	—	1108	0,9	
TB 32 L 075	32	3F	GG	97,02	96,26	103	25,0	25,0	25,0	—	—	—	—	1108	1,0	
TB 36 L 075	36	3F	GG	109,15	108,39	115	25,0	25,0	25,0	—	—	—	—	1610	1,2	
TB 40 L 075	40	3F	GG	121,28	120,51	127	25,0	25,0	25,0	—	—	—	—	1610	1,7	
TB 48 L 075	48	3WF	GG	145,53	144,77	152	25,0	25,0	25,0	—	—	92	124	1610	2,5	
TB 60 L 075	60	3W	GG	181,91	181,15	—	25,0	25,0	25,0	—	—	92	166	1610	3,0	
TB 72 L 075	72	3A	GG	218,30	217,53	—	25,0	25,0	25,0	—	—	92	202	1610	4,0	
TB 84 L 075	84	7A	GG	254,68	253,90	—	25,0	32,0	32,0	3,5	—	106	236	2012	5,2	
TB 96 L 075	96	7A	GG	291,06	290,30	—	25,0	32,0	32,0	3,5	—	106	270	2012	6,5	
TB 120 L 075	120	7A	GG	363,83	363,07	—	25,0	32,0	32,0	3,5	—	106	343	2012	7,6	

Taperbuchse Taper bush	1108	1610	2012
Bohrung d ₂ (mm) von ... bis ... Bore d ₂ (mm) from ... to ...	10-28	14-42	14-50
€/Stück each	auf Anfrage / on request		

St = Stahl Steel
GG = Grauguss Cast iron
Fertigungstechnische Änderungen vorbehalten.
We reserve the right to make technical changes.
Bohrungsdurchmesser d₂ siehe Seite 3-4.
Bore diameters d₂ see page 3-4.

Standard-Zahnscheiben für Taperbuchsen Timing belt pulleys for taper bushes

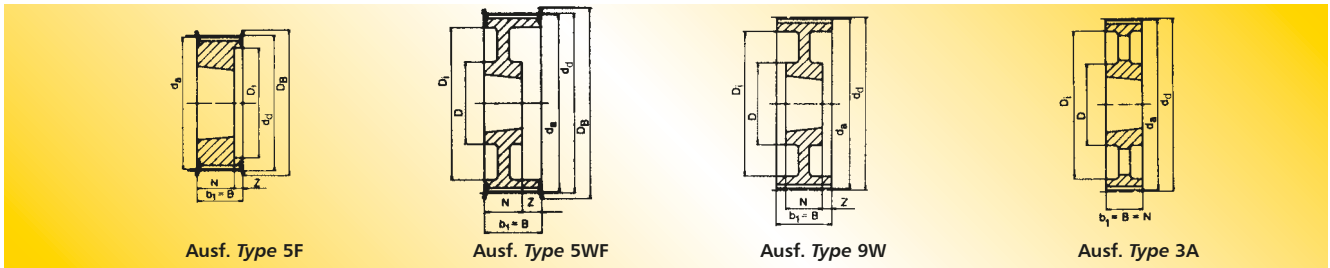

Type L – Teilung Pitch 9,525 mm für Riemenbreite for belt width 100

Bezeichnung Part No.	Anzahl der Zähne No. of teeth	Aus- führung Type	Material	d _d (mm)	d _s (mm)	D _B (mm)	b ₁ (mm)	B (mm)	N (mm)	V (mm)	Z (mm)	D (mm)	D ₁ (mm)	Taper- Buchse Taper bush	Gewicht ohne Buchse Weight without bush (= kg)	€ Stück ohne Buchse each without bush
TB 18 L 100	18	5F	St	54,57	53,81	60	31,0	31,0	22,0	—	9,0	—	38	1108	0,2	auf Anfrage on request
TB 19 L 100	19	5F	St	57,61	56,84	60	31,0	31,0	22,0	—	9,0	—	38	1108	0,3	
TB 20 L 100	20	5F	St	60,64	59,88	66	31,0	31,0	22,0	—	9,0	—	45	1108	0,4	
TB 21 L 100	21	5F	St	63,67	62,91	71	31,0	31,0	22,0	—	9,0	—	47	1108	0,4	
TB 22 L 100	22	5F	St	66,70	65,94	75	31,0	31,0	22,0	—	9,0	—	51	1108	0,4	
TB 23 L 100	23	5F	GG	69,73	68,97	79	32,0	32,0	22,0	—	10,0	—	54	1108	0,5	
TB 24 L 100	24	5F	GG	72,77	72,00	79	32,0	32,0	22,0	—	10,0	—	54	1108	0,6	
TB 25 L 100	25	5F	GG	75,80	75,04	83	32,0	32,0	22,0	—	10,0	—	56	1108	0,6	
TB 26 L 100	26	5F	GG	78,83	78,07	87	32,0	32,0	22,0	—	10,0	—	60	1108	0,7	
TB 27 L 100	27	5F	GG	81,86	81,10	87	32,0	32,0	22,0	—	10,0	—	62	1108	0,8	
TB 28 L 100	28	5F	GG	84,89	84,13	91	32,0	32,0	22,0	—	10,0	—	65	1108	0,8	
TB 30 L 100	30	5F	GG	90,96	90,20	97	32,0	32,0	25,0	—	7,0	—	71	1210	0,9	
TB 32 L 100	32	5F	GG	97,02	96,26	103	32,0	32,0	25,0	—	7,0	—	75	1210	1,0	
TB 36 L 100	36	5F	GG	109,15	108,39	115	32,0	32,0	25,0	—	7,0	—	89	1610	1,4	
TB 40 L 100	40	5F	GG	121,28	120,51	127	32,0	32,0	25,0	—	7,0	—	101	1610	1,7	
TB 48 L 100	48	5WF	GG	145,53	144,77	152	32,0	32,0	25,0	—	7,0	92	124	1610	2,7	
TB 60 L 100	60	9W	GG	181,91	181,15	—	32,0	32,0	25,0	—	3,5	92	166	1610	2,4	
TB 72 L 100	72	3A	GG	218,30	217,53	—	32,0	32,0	32,0	—	—	106	202	2012	4,4	
TB 84 L 100	84	3A	GG	254,68	253,90	—	32,0	32,0	32,0	—	—	106	236	2012	6,0	
TB 96 L 100	96	3A	GG	291,06	290,30	—	32,0	32,0	32,0	—	—	106	270	2012	7,1	
TB 120 L 100	120	3A	GG	363,83	363,07	—	32,0	32,0	32,0	—	—	106	343	2012	8,5	

Taperbuchse Taper bush	1108	1210	1610	2012
Bohrung d ₂ (mm) von ... bis ... Bore d ₂ (mm) from ... to ...	10-28	11-32	14-42	14-50
€/Stück each	auf Anfrage / on request			

St = Stahl Steel/
GG = Grauguss Cast iron
Fertigungstechnische Änderungen vorbehalten.
We reserve the right to make technical changes.
Bohrungsdurchmesser d₂ siehe Seite 3-4.
Bore diameters d₂ see page 3-4.

Standard-Zahnscheiben für Taperbuchsen

Timing belt pulleys for taper bushes

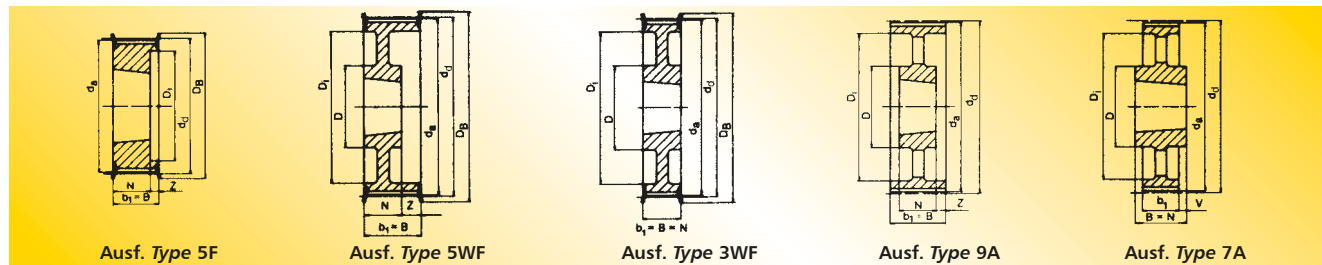

Type H – Teilung Pitch 12,7 mm für Riemenbreite for belt width 100

Bezeichnung Part No.	Anzahl der Zähne No. of teeth	Aus- führung Type	Material	d _d (mm)	d _s (mm)	D _B (mm)	b ₁ (mm)	B (mm)	N (mm)	V (mm)	Z (mm)	D (mm)	D _i (mm)	Taper- Buchse Taper bush	Gewicht ohne Buchse Weight without bush (≈ kg)	€ Stück ohne Buchse each without bush
TB 16 H 100	16	5F	St	64,68	63,31	71	31,0	31,0	22,0	—	9,0	—	45	1108	0,4	auf Anfrage on request
TB 18 H 100	18	5F	St	72,77	71,39	79	31,0	31,0	25,0	—	6,0	—	52	1210	0,5	
TB 19 H 100	19	5F	St	76,81	75,44	83	31,0	31,0	25,0	—	6,0	—	56	1210	0,6	
TB 20 H 100	20	5F	St	80,55	79,48	87	31,0	31,0	25,0	—	6,0	—	60	1210	0,7	
TB 21 H 100	21	5F	GG	84,89	83,52	91	32,0	32,0	25,0	—	7,0	—	63	1210	0,8	
TB 22 H 100	22	5F	GG	88,94	87,56	93	32,0	32,0	25,0	—	7,0	—	67	1210	0,9	
TB 23 H 100	23	5F	GG	92,98	91,61	97	32,0	32,0	25,0	—	7,0	—	71	1610	0,9	
TB 24 H 100	24	5F	GG	97,02	95,65	103	32,0	32,0	25,0	—	7,0	—	75	1610	1,0	
TB 25 H 100	25	5F	GG	101,06	99,69	106	32,0	32,0	25,0	—	7,0	—	79	1610	1,0	
TB 26 H 100	26	5F	GG	105,11	103,73	111	32,0	32,0	25,0	—	7,0	—	83	1610	1,2	
TB 27 H 100	27	5F	GG	109,15	107,78	115	32,0	32,0	25,0	—	7,0	—	87	1610	1,3	
TB 28 H 100	28	5F	GG	113,19	111,82	119	32,0	32,0	25,0	—	7,0	—	91	1610	1,5	
TB 30 H 100	30	5F	GG	121,28	119,90	127	32,0	32,0	25,0	—	7,0	—	99	1610	1,7	
TB 32 H 100	32	5WF	GG	129,36	127,99	135	32,0	32,0	25,0	—	7,0	92	108	1610	2,0	
TB 36 H 100	36	5WF	GG	145,53	144,16	152	32,0	32,0	25,0	—	7,0	92	124	1610	2,7	
TB 40 H 100	40	5WF	GG	161,70	160,33	168	32,0	32,0	25,0	—	7,0	92	140	1610	3,6	
TB 44 H 100	44	3WF	GG	177,87	176,50	184	32,0	32,0	32,0	—	—	106	153	2012	3,8	
TB 48 H 100	48	3WF	GG	194,04	192,67	200	32,0	32,0	32,0	—	—	106	169	2012	3,2	
TB 60 H 100	60	9A	GG	242,55	241,18	—	34,0	34,0	32,0	—	1,0	106	223	2012	4,8	
TB 72 H 100	72	9A	GG	291,06	289,69	—	34,0	34,0	32,0	—	1,0	106	270	2012	5,7	
TB 84 H 100	84	9A	GG	339,57	338,20	—	34,0	34,0	32,0	—	1,0	106	318	2012	6,8	
TB 96 H 100	96	7A	GG	388,08	386,71	—	34,0	45,0	45,0	5,5	—	119	366	2517	8,2	
TB 120 H 100	120	7A	GG	485,10	483,73	—	34,0	45,0	45,0	5,5	—	119	462	2517	12,1	

Type H – Teilung Pitch 12,7 mm für Riemenbreite for belt width 150

TB 18 H 150	18	5F	St	72,77	71,39	79	45,0	45,0	25,0	—	20,0	—	53	1210	0,6	auf Anfrage on request
TB 19 H 150	19	5F	St	76,81	75,44	83	45,0	45,0	25,0	—	20,0	—	56	1210	0,7	
TB 20 H 150	20	5F	St	80,55	79,48	87	45,0	45,0	25,0	—	20,0	—	60	1210	0,8	
TB 21 H 150	21	5F	GG	84,89	83,52	91	45,0	45,0	25,0	—	20,0	—	64	1210	1,0	
TB 22 H 150	22	5F	GG	88,94	87,56	93	45,0	45,0	25,0	—	20,0	—	68	1210	1,2	
TB 23 H 150	23	5F	GG	92,98	91,61	97	45,0	45,0	25,0	—	20,0	—	71	1610	1,3	
TB 24 H 150	24	5F	GG	97,02	95,65	103	45,0	45,0	25,0	—	20,0	—	74	1610	1,2	
TB 25 H 150	25	5F	GG	101,06	99,69	106	45,0	45,0	25,0	—	20,0	—	78	1610	1,2	
TB 26 H 150	26	5F	GG	105,11	103,73	111	45,0	45,0	25,0	—	20,0	—	82	1610	1,4	
TB 27 H 150	27	5F	GG	109,15	107,78	115	45,0	45,0	25,0	—	20,0	—	87	1610	1,6	
TB 28 H 150	28	5F	GG	113,19	111,82	119	45,0	45,0	25,0	—	20,0	—	91	1610	1,8	
TB 30 H 150	30	5F	GG	121,28	119,90	127	45,0	45,0	25,0	—	20,0	—	99	1610	2,0	
TB 32 H 150	32	5WF	GG	129,36	127,99	135	45,0	45,0	25,0	—	20,0	92	108	1610	2,3	
TB 36 H 150	36	5WF	GG	145,53	144,16	152	45,0	45,0	25,0	—	20,0	92	124	1610	3,1	
TB 40 H 150	40	5WF	GG	161,70	160,33	168	45,0	45,0	25,0	—	20,0	92	140	1610	4,0	
TB 44 H 150	44	5WF	GG	177,87	176,50	184	45,0	45,0	32,0	—	13,0	106	153	2012	4,4	
TB 48 H 150	48	5WF	GG	194,04	192,67	200	45,0	45,0	32,0	—	13,0	106	169	2012	4,8	
TB 60 H 150	60	9A	GG	242,55	241,18	—	46,0	46,0	32,0	—	7,0	106	223	2012	5,4	
TB 72 H 150	72	9A	GG	291,06	289,69	—	46,0	46,0	32,0	—	7,0	106	270	2012	6,5	
TB 84 H 150	84	9A	GG	339,57	338,20	—	46,0	46,0	32,0	—	7,0	106	320	2012	8,4	
TB 96 H 150	96	9A	GG	388,08	386,71	—	46,0	46,0	45,0	—	0,5	119	366	2517	11,0	
TB 120 H 150	120	9A	GG	485,10	483,73	—	46,0	46,0	45,0	—	0,5	119	462	2517	14,8	

Taperbuchse Taper bush	1108	1210	1610	2012	2517
Bohrung d ₂ (mm) von ... bis ... Bore d ₂ (mm) from ... to ...	10-28	11-32	14-42	14-50	16-60
€/Stück each	auf Anfrage / on request				

St = Stahl Steel – GG = Grauguss Cast iron
Fertigungstechnische Änderungen vorbehalten.
We reserve the right to make technical changes.

Bohrungsdurchmesser d₂ siehe Seite 3-4.
Bore diameters d₂ see page 3-4.

Standard-Zahnscheiben für Taperbuchsen Timing belt pulleys for taper bushes

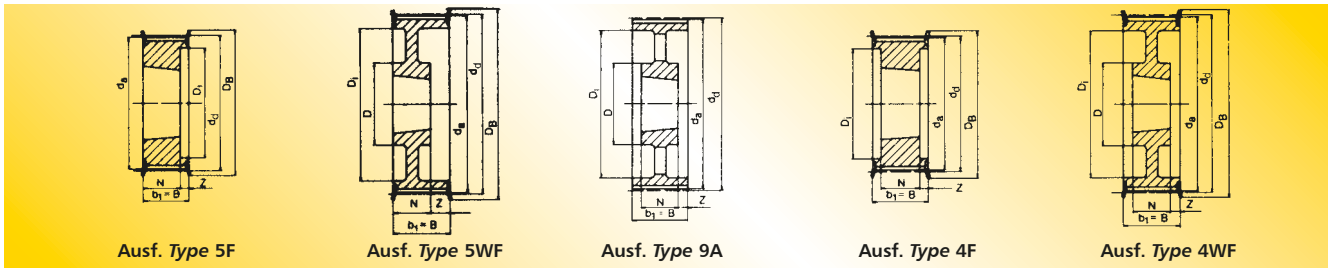

Type H – Teilung Pitch 12,7 mm für Riemenbreite for belt width 200

Bezeichnung Part No.	Anzahl der Zähne No. of teeth	Aus- führung Type	Material	d _d (mm)	d _s (mm)	D _B (mm)	b ₁ (mm)	B (mm)	N (mm)	V (mm)	Z (mm)	D (mm)	D _i (mm)	Taper- Buchse Taper bush	Gewicht ohne Buchse Weight without bush (= kg)	€ Stück ohne Buchse each without bush
TB 18 H 200	18	5F	St	72,77	71,39	79	58,0	58,0	25,0	—	33,0	—	52	1210	0,8	auf Anfrage on request
TB 19 H 200	19	5F	St	76,81	75,44	83	58,0	58,0	25,0	—	33,0	—	56	1610	0,9	
TB 20 H 200	20	5F	St	80,55	79,48	87	58,0	58,0	25,0	—	33,0	—	60	1610	1,0	
TB 21 H 200	21	5F	GG	84,89	83,52	91	58,0	58,0	25,0	—	33,0	—	64	1610	1,7	
TB 22 H 200	22	5F	GG	88,94	87,56	93	58,0	58,0	25,0	—	33,0	—	68	1610	1,5	
TB 23 H 200	23	5F	GG	92,98	91,61	97	58,0	58,0	25,0	—	33,0	—	71	1610	1,8	
TB 24 H 200	24	5F	GG	97,02	95,65	103	58,0	58,0	25,0	—	33,0	—	74	1610	1,5	
TB 25 H 200	25	5F	GG	101,06	99,69	106	58,0	58,0	25,0	—	33,0	—	78	1610	1,5	
TB 26 H 200	26	5F	GG	105,11	103,73	111	58,0	58,0	25,0	—	33,0	—	82	1610	1,8	
TB 27 H 200	27	5F	GG	109,15	107,78	115	58,0	58,0	25,0	—	33,0	—	87	1610	1,9	
TB 28 H 200	28	5F	GG	113,19	111,82	119	58,0	58,0	25,0	—	33,0	—	91	1610	1,9	
TB 30 H 200	30	5F	GG	121,28	119,90	127	58,0	58,0	25,0	—	33,0	—	99	1610	2,3	
TB 32 H 200	32	5F	GG	129,36	127,99	135	58,0	58,0	32,0	—	26,0	—	107	2012	3,0	
TB 36 H 200	36	5WF	GG	145,53	144,16	152	58,0	58,0	32,0	—	26,0	102	124	2012	3,0	
TB 40 H 200	40	5WF	GG	161,70	160,33	168	58,0	58,0	32,0	—	26,0	106	140	2012	3,6	
TB 44 H 200	44	5WF	GG	177,87	176,50	184	58,0	58,0	32,0	—	26,0	106	153	2012	4,5	
TB 48 H 200	48	5WF	GG	194,04	192,67	200	58,0	58,0	45,0	—	13,0	119	169	2517	4,6	
TB 60 H 200	60	9A	GG	242,55	241,18	—	60,0	60,0	45,0	—	7,5	119	223	2517	7,0	
TB 72 H 200	72	9A	GG	291,06	289,69	—	60,0	60,0	45,0	—	7,5	119	270	2517	8,0	
TB 84 H 200	84	9A	GG	339,57	338,20	—	60,0	60,0	45,0	—	7,5	119	320	2517	9,0	
TB 96 H 200	96	9A	GG	388,08	386,71	—	60,0	60,0	45,0	—	7,5	119	366	2517	11,5	
TB 120 H 200	120	9A	GG	485,10	483,73	—	60,0	60,0	45,0	—	7,5	119	462	2517	15,4	

Type H – Teilung Pitch 12,7 mm für Riemenbreite for belt width 300

TB 20 H 300	20	4F	St	80,55	79,48	87	84,0	84,0	38,0	—	23,0	—	65	1615	1,5	auf Anfrage on request
TB 21 H 300	21	4F	GG	84,89	83,52	91	84,0	84,0	38,0	—	23,0	—	66	1615	1,2	
TB 22 H 300	22	4F	GG	88,94	87,56	93	84,0	84,0	38,0	—	23,0	—	67	1615	1,6	
TB 23 H 300	23	4F	GG	92,98	91,61	97	84,0	84,0	38,0	—	23,0	—	71	1615	1,8	
TB 24 H 300	24	4F	GG	97,02	95,65	103	84,0	84,0	38,0	—	23,0	—	75	1615	2,1	
TB 25 H 300	25	4F	GG	101,06	99,69	106	84,0	84,0	38,0	—	23,0	—	79	1615	2,0	
TB 26 H 300	26	4F	GG	105,11	103,73	111	84,0	84,0	38,0	—	23,0	—	83	1615	2,7	
TB 27 H 300	27	4F	GG	109,15	107,78	115	84,0	84,0	32,0	—	26,0	—	87	2012	3,0	
TB 28 H 300	28	4F	GG	113,19	111,82	119	84,0	84,0	32,0	—	26,0	—	91	2012	2,4	
TB 30 H 300	30	4F	GG	121,28	119,90	127	84,0	84,0	32,0	—	26,0	—	99	2012	2,9	
TB 32 H 300	32	4F	GG	129,36	127,99	135	84,0	84,0	45,0	—	19,5	—	107	2517	3,3	
TB 36 H 300	36	4F	GG	145,53	144,16	152	84,0	84,0	45,0	—	19,5	—	124	2517	4,5	
TB 40 H 300	40	4F	GG	161,70	160,33	168	84,0	84,0	45,0	—	19,5	—	137	2517	6,0	
TB 44 H 300	44	4WF	GG	177,87	176,50	184	86,0	86,0	45,0	—	20,5	119	153	2517	6,6	
TB 48 H 300	48	4WF	GG	194,04	192,67	200	86,0	86,0	45,0	—	20,5	119	169	2517	7,6	
TB 60 H 300	60	9A	GG	242,55	241,18	—	86,0	86,0	45,0	—	20,5	119	223	2517	8,4	
TB 72 H 300	72	9A	GG	291,06	289,69	—	86,0	86,0	45,0	—	20,5	119	270	2517	10,4	
TB 84 H 300	84	9A	GG	339,57	338,20	—	86,0	86,0	45,0	—	20,5	119	320	2517	12,5	
TB 96 H 300	96	9A	GG	388,08	386,71	—	86,0	86,0	76,0	—	5,0	150	362	3030	14,2	
TB 120 H 300	120	9A	GG	485,10	483,73	—	86,0	86,0	76,0	—	5,0	150	460	3030	18,8	

Taperbuchse Taper bush	1210	1610	1615	2012	2517	3030
Bohrung d ₂ (mm) von ... bis ... Bore d ₂ (mm) from ... to ...	11-32	14-42	14-42	14-50	16-60	35-75
€/Stück each	auf Anfrage / on request					

St = Stahl Steel – GG = Grauguss Cast iron
Fertigungstechnische Änderungen vorbehalten.
We reserve the right to make technical changes.

Bohrungsdurchmesser d₂ siehe Seite 3-4.
Bore diameters d₂ see page 3-4.

Standard-Zahnscheiben für Taperbuchsen

Timing belt pulleys for taper bushes

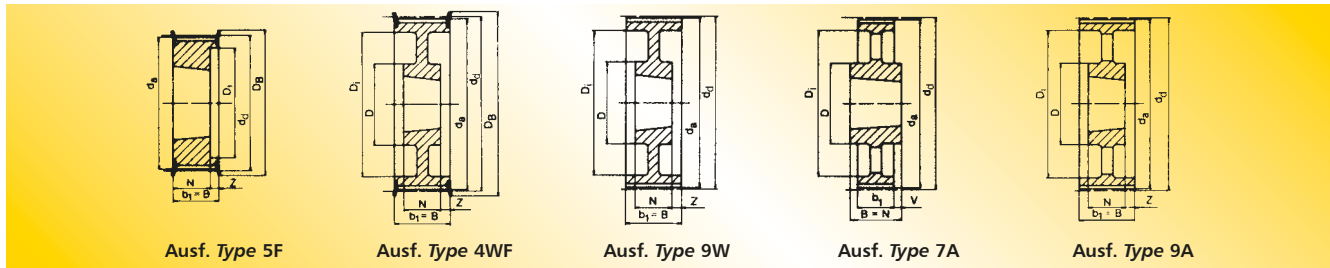

Type XH – Teilung Pitch 22,225 mm für Riemenbreite for belt width 200

Bezeichnung Part No.	Anzahl der Zähne No. of teeth	Aus- führung Type	Material	d _d (mm)	d _s (mm)	D _B (mm)	b ₁ (mm)	B (mm)	N (mm)	V (mm)	Z (mm)	D (mm)	D _i (mm)	Taper- Buchse Taper bush	Gewicht ohne Buchse Weight without bush (≈ kg)	€ Stück ohne Buchse each without bush
TB 18 XH 200	18	5F	GG	127,34	124,55	138	64	64	45	—	20,0	—	95	2517	2,6	auf Anfrage on request
TB 20 XH 200	20	5F	GG	141,49	138,69	154	64	64	45	—	20,0	—	110	2517	3,6	
TB 22 XH 200	22	5F	GG	155,64	152,84	168	64	64	45	—	20,0	—	120	2517	4,8	
TB 24 XH 200	24	5F	GG	169,79	166,69	183	64	64	45	—	20,0	—	135	2517	6,1	
TB 26 XH 200	26	5F	GG	183,94	181,14	198	64	64	45	—	20,0	—	150	2517	7,4	
TB 28 XH 200	28	4WF	GG	198,08	195,29	211	64	64	45	—	10,0	120	165	2517	9,0	
TB 30 XH 200	30	4WF	GG	212,23	209,44	226	64	64	45	—	10,0	120	180	2517	8,6	
TB 32 XH 200	32	4WF	GG	226,38	223,59	240	64	64	45	—	10,0	120	195	2517	9,8	
TB 40 XH 200	40	4WF	GG	282,98	280,18	296	64	64	51	—	6,5	160	245	3020	13,3	
TB 48 XH 200	48	9W	GG	339,57	336,78	—	64	64	51	—	6,5	160	300	3020	19,0	

Type XH – Teilung Pitch 22,225 mm für Riemenbreite for belt width 300

TB 18 XH 300	18	5F	GG	127,34	124,55	138	90	90	45	—	45,0	—	95	2517	3,7	auf Anfrage on request
TB 20 XH 300	20	5F	GG	141,49	138,69	154	90	90	45	—	45,0	—	110	2517	4,7	
TB 22 XH 300	22	5F	GG	155,64	152,84	168	90	90	45	—	45,0	—	120	2517	6,0	
TB 24 XH 300	24	5F	GG	169,79	166,69	183	90	90	45	—	45,0	—	135	2517	7,6	
TB 26 XH 300	26	5F	GG	183,94	181,14	198	90	90	45	—	45,0	—	150	2517	9,8	
TB 28 XH 300	28	5F	GG	198,08	195,29	211	90	90	51	—	39,0	—	165	3020	11,6	
TB 30 XH 300	30	5F	GG	212,23	209,44	226	90	90	51	—	39,0	—	180	3020	11,9	
TB 32 XH 300	32	5F	GG	226,38	223,59	240	90	90	51	—	39,0	—	195	3020	13,8	
TB 40 XH 300	40	4WF	GG	282,98	280,18	296	90	90	51	—	19,5	160	245	3020	19,5	
TB 48 XH 300	48	9W	GG	339,57	336,78	—	90	90	51	—	19,5	160	300	3020	27,0	

Taperbuchse Taper bush	2517	3020	3535	4040
Bohrung d ₂ (mm) von ... bis ... Bore d ₂ (mm) from ... to ...	16-60	25-75	35-90	40-100
€/Stück each	auf Anfrage / on request			

GG = Grauguss Cast iron
Fertigungstechnische Änderungen vorbehalten.
We reserve the right to make technical changes.

Bohrungsdurchmesser d₂ siehe Seite 3-4.
Bore diameters d₂ see page 3-4.

Standard-Zahnscheiben für Taperbuchsen Timing belt pulleys for taper bushes

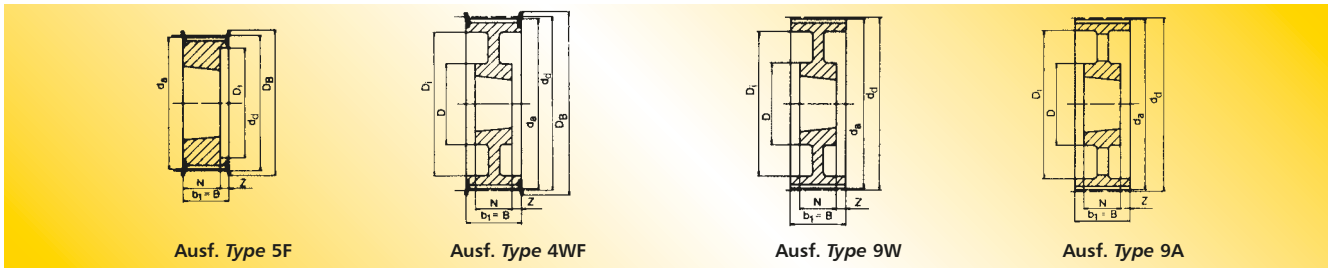

Type XH – Teilung Pitch 22,225 mm für Riemenbreite for belt width 400

Bezeichnung Part No.	Anzahl der Zähne No. of teeth	Aus- führung Type	Mate- rial	d_d (mm)	d_s (mm)	D_B (mm)	b_1 (mm)	B (mm)	N (mm)	V (mm)	Z (mm)	D (mm)	D_1 (mm)	Taper- Buchse Taper bush	Gewicht ohne Buchse Weight without bush (= kg)	€ Stück ohne Buchse each without bush
TB 20 XH 400	20	5F	GG	141,49	138,69	154	119	119	45	—	74,0	—	110	2517	6,0	auf Anfrage on request
TB 22 XH 400	22	5F	GG	155,64	152,84	168	119	119	45	—	74,0	—	120	2517	7,2	
TB 24 XH 400	24	5F	GG	169,79	166,69	183	119	119	51	—	68,0	—	135	3020	8,4	
TB 26 XH 400	26	5F	GG	183,94	181,14	198	119	119	51	—	68,0	—	150	3020	10,3	
TB 28 XH 400	28	5F	GG	198,08	195,29	211	119	119	51	—	68,0	—	165	3020	12,3	
TB 30 XH 400	30	5F	GG	212,23	209,44	226	119	119	51	—	68,0	—	180	3020	14,3	
TB 32 XH 400	32	5F	GG	226,38	223,59	240	119	119	51	—	68,0	—	195	3020	19,9	
TB 40 XH 400	40	4WF	GG	282,98	280,18	296	119	119	89	—	15,0	190	245	3535	24,6	
TB 48 XH 400	48	9W	GG	339,57	336,78	—	119	119	89	—	15,0	190	300	3535	30,0	

Taperbuchse Taper bush	2517	3020	3535	4040
Bohrung d_2 (mm) von ... bis ... Bore d_2 (mm) from ... to ...	16-60	25-75	35-90	40-100
€/Stück each	auf Anfrage / on request			

GG = Grauguss Cast iron
Fertigungstechnische Änderungen vorbehalten.
We reserve the right to make technical changes.

Bohrungsdurchmesser d_2 siehe Seite 3-4.
Bore diameters d_2 see page 3-4.

HTD®-Zahnscheiben für zylindrische Bohrung HTD® pulleys for plain boring

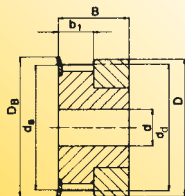

Ausf. Type 1F

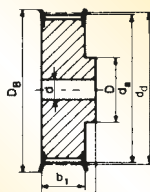

Ausf. Type 6F

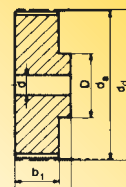

Ausf. Type 6

Type 3M – Teilung Pitch 3 mm für Riemenbreite for belt width 6 mm keine Lagerware non stock items

Bezeichnung Part No.	Anzahl der Zähne No. of teeth	Aus- führung Type	Material	d _d (mm)	d _s (mm)	D _B (mm)	b ₁ (mm)	B (mm)	D (mm)	Vor- bohrung Pilot bore d (mm)	Fertig- bohrung Finished bore d _{max} (mm)	Gewicht Weight (≈ kg)	€ Stück each
10-3M-6	10	1F	Al	9,55	8,79	13,0	7,2	14,5	13,0	—	3		auf Anfrage on request
12-3M-6	12	1F	Al	11,46	10,70	15,0	7,2	14,5	15,0	—	5		
14-3M-6	14	1F	Al	13,37	12,61	16,0	7,2	14,5	16,0	—	6		
15-3M-6	15	1F	Al	14,32	13,56	17,5	7,2	14,5	17,5	—	6		
16-3M-6	16	6F	Al	15,28	14,52	18,0	9,8	17,5	10,0	4	7		
18-3M-6	18	6F	Al	17,19	16,43	19,5	9,8	17,5	11,0	6	8		
20-3M-6	20	6F	Al	19,10	18,34	23,0	9,8	17,5	13,0	6	9		
21-3M-6	21	6F	Al	20,05	19,29	25,0	9,8	17,5	14,0	6	9		
22-3M-6	22	6F	Al	21,01	20,25	25,0	9,8	17,5	14,0	6	9		
24-3M-6	24	6F	Al	22,92	22,16	25,0	9,8	17,5	14,0	6	9		
26-3M-6	26	6F	Al	24,83	24,07	28,0	9,8	17,5	16,0	6	11		
28-3M-6	28	6F	Al	26,74	25,98	32,0	9,8	17,5	18,0	6	12		
30-3M-6	30	6F	Al	28,65	27,89	32,0	9,8	17,5	20,0	6	14		
32-3M-6	32	6F	Al	30,56	29,80	36,0	9,8	17,5	22,0	6	15		
36-3M-6	36	6F	Al	34,38	33,62	38,0	10,3	18,0	26,0	6	16		
40-3M-6	40	6F	Al	38,20	37,44	42,0	10,3	18,0	28,0	6	18		
44-3M-6	44	6F	Al	42,02	41,26	48,0	10,3	18,0	33,0	6	20		
48-3M-6	48	6	Al	45,84	45,08	—	10,3	18,6	33,0	8	20		
60-3M-6	60	6	Al	57,30	56,54	—	10,3	18,6	33,0	8	20		
72-3M-6	72	6	Al	68,75	67,99	—	10,3	18,6	33,0	8	20		

Type 3M – Teilung Pitch 3 mm für Riemenbreite for belt width 9 mm

10-3M-9	10	1F	Al	9,55	8,79	13,0	10,2	17,5	13,0	—	3	0,004	auf Anfrage on request
12-3M-9	12	1F	Al	11,46	10,70	15,0	10,2	17,5	15,0	—	5	0,006	
14-3M-9	14	1F	Al	13,37	12,61	16,0	10,2	17,5	16,0	—	6	0,007	
15-3M-9	15	1F	Al	14,32	13,56	17,5	10,2	17,5	17,5	—	6	0,008	
16-3M-9	16	6F	Al	15,28	14,52	18,0	12,8	20,6	10,0	4	7	0,007	
18-3M-9	18	6F	Al	17,19	16,43	19,5	12,8	20,6	11,0	6	8	0,008	
20-3M-9	20	6F	Al	19,10	18,34	23,0	12,8	20,6	13,0	6	9	0,010	
21-3M-9	21	6F	Al	20,05	19,29	25,0	12,8	20,6	14,0	6	9	0,013	
22-3M-9	22	6F	Al	21,01	20,25	25,0	12,8	20,6	14,0	6	9	0,014	
24-3M-9	24	6F	Al	22,92	22,16	25,0	12,8	20,6	14,0	6	9	0,016	
26-3M-9	26	6F	Al	24,83	24,07	28,0	12,8	20,6	16,0	6	11	0,018	
28-3M-9	28	6F	Al	26,74	25,98	32,0	12,8	20,6	18,0	6	12	0,024	
30-3M-9	30	6F	Al	28,65	27,89	32,0	12,8	20,6	20,0	6	14	0,028	
32-3M-9	32	6F	Al	30,56	29,80	36,0	12,8	20,6	22,0	6	15	0,032	
36-3M-9	36	6F	Al	34,38	33,62	38,0	13,4	22,2	26,0	6	16	0,045	
40-3M-9	40	6F	Al	38,20	37,44	42,0	13,4	22,2	28,0	6	18	0,055	
44-3M-9	44	6F	Al	42,02	41,26	48,0	13,4	22,2	33,0	6	20	0,074	
48-3M-9	48	6	Al	45,84	45,08	—	13,4	22,2	33,0	8	20	0,074	
60-3M-9	60	6	Al	57,30	56,54	—	13,4	22,2	33,0	8	20	0,106	
72-3M-9	72	6	Al	68,75	67,99	—	13,4	22,2	33,0	8	20	0,145	

Al = Aluminium

Fertigungstechnische Änderungen vorbehalten. We reserve the right to make technical changes.

HTD®-Zahnscheiben für zylindrische Bohrung HTD® pulleys for plain boring

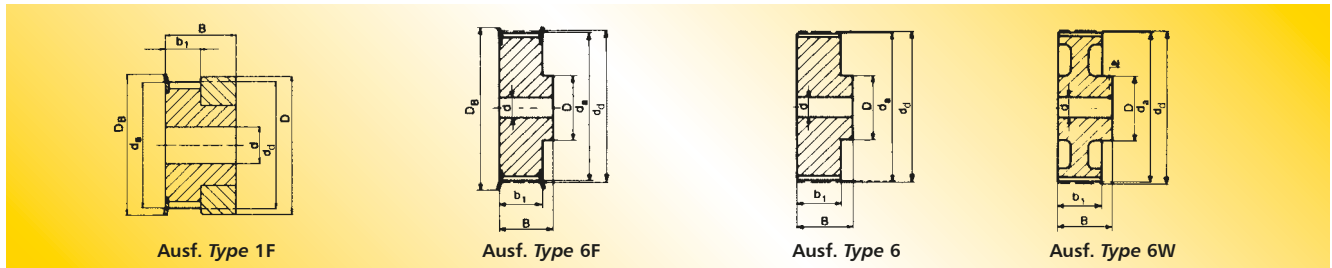

Type 3M – Teilung Pitch 3 mm für Riemenbreite for belt width 15 mm

Bezeichnung Part No.	Anzahl der Zähne No. of teeth	Aus- führung Type	Material	d _d (mm)	d _s (mm)	D _B (mm)	b ₁ (mm)	B (mm)	D (mm)	Vor- bohrung Pilot bore d (mm)	Fertig- bohrung Finished bore d _{max} (mm)	Gewicht Weight (≈ kg)	€ Stück each
10-3M-15	10	1F	Al	9,55	8,79	13,0	17,0	26	13,0	—	3	0,006	auf Anfrage on request
12-3M-15	12	1F	Al	11,46	10,70	15,0	17,0	26	15,0	—	5	0,008	
14-3M-15	14	1F	Al	13,37	12,61	16,0	17,0	26	16,0	—	6	0,010	
15-3M-15	15	1F	Al	14,32	13,56	17,5	17,0	26	17,5	—	6	0,012	
16-3M-15	16	6F	Al	15,28	14,52	18,0	19,5	26	10,0	4	7	0,010	
18-3M-15	18	6F	Al	17,19	16,43	19,5	19,5	26	11,0	6	8	0,012	
20-3M-15	20	6F	Al	19,10	18,34	23,0	19,5	26	13,0	6	9	0,014	
21-3M-15	21	6F	Al	20,05	19,29	25,0	19,5	26	14,0	6	9	0,016	
22-3M-15	22	6F	Al	21,01	20,25	25,0	19,5	26	14,0	6	9	0,018	
24-3M-15	24	6F	Al	22,92	22,16	25,0	19,5	26	14,0	6	9	0,020	
26-3M-15	26	6F	Al	24,83	24,07	28,0	19,5	26	16,0	6	11	0,027	
28-3M-15	28	6F	Al	26,74	25,98	32,0	19,5	26	18,0	6	12	0,030	
30-3M-15	30	6F	Al	28,65	27,89	32,0	19,5	26	20,0	6	14	0,035	
32-3M-15	32	6F	Al	30,56	29,80	36,0	19,5	26	22,0	6	15	0,042	
36-3M-15	36	6F	Al	34,38	33,62	38,0	20,0	30	26,0	6	16	0,060	
40-3M-15	40	6F	Al	38,20	37,44	42,0	20,0	30	28,0	6	18	0,075	
44-3M-15	44	6F	Al	42,02	41,26	48,0	20,0	30	33,0	6	20	0,100	
48-3M-15	48	6	Al	45,84	45,08	—	20,0	30	33,0	8	20	0,103	
60-3M-15	60	6	Al	57,30	56,54	—	20,0	30	33,0	8	20	0,150	
72-3M-15	72	6	Al	68,75	67,99	—	20,0	30	33,0	8	20	0,212	

Type 5M – Teilung Pitch 5 mm für Riemenbreite for belt width 9 mm

12-5M-9	12	6F	St	19,10	17,96	23	14,5	20,0	13,0	4	7	0,028	auf Anfrage on request
14-5M-9	14	6F	St	22,28	21,14	25	14,5	20,0	14,0	6	8	0,034	
15-5M-9	15	6F	St	23,87	22,73	28	14,5	20,0	16,0	6	10	0,042	
16-5M-9	16	6F	St	25,46	24,32	28	14,5	20,0	16,5	6	10	0,050	
18-5M-9	18	6F	St	28,65	27,51	32	14,5	20,0	20,0	6	12	0,070	
20-5M-9	20	6F	St	31,83	30,69	36	14,5	22,5	23,0	6	14	0,094	
21-5M-9	21	6F	St	33,42	32,28	38	14,5	22,5	24,0	6	14	0,110	
22-5M-9	22	6F	St	35,01	33,87	38	14,5	22,5	25,5	6	14	0,118	
24-5M-9	24	6F	St	38,20	37,06	42	14,5	22,5	27,0	6	16	0,145	
26-5M-9	26	6F	St	41,38	40,24	44	14,5	22,5	30,0	6	18	0,170	
28-5M-9	28	6F	St	44,56	43,42	48	14,5	22,5	30,5	6	18	0,200	
30-5M-9	30	6F	St	47,75	46,61	51	14,5	22,5	35,0	6	20	0,236	
32-5M-9	32	6F	St	50,93	49,79	54	14,5	22,5	38,0	8	22	0,270	
36-5M-9	36	6F	St	57,30	56,16	60	14,5	22,5	38,0	8	22	0,324	
40-5M-9	40	6F	St	63,66	62,52	71	14,5	22,5	38,0	8	22	0,400	
44-5M-9	44	6W	Al	70,03	68,89	—	14,5	25,5	38,0	8	22	0,170	
48-5M-9	48	6W	Al	76,39	75,25	—	14,5	25,5	45,0	8	25	0,182	
60-5M-9	60	6W	Al	95,49	94,35	—	14,5	25,5	45,0	8	25	0,230	
72-5M-9	72	6W	Al	114,59	113,45	—	14,5	25,5	45,0	8	25	0,270	

HTD®-Zahnscheiben für zylindrische Bohrung HTD® pulleys for plain boring

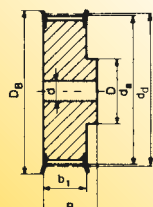

Ausf. Type 6F

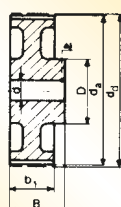

Ausf. Type 6W

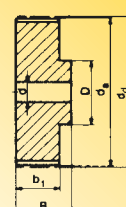

Ausf. Type 6

Type 5M – Teilung Pitch 5 mm für Riemenbreite for belt width 15 mm

Bezeichnung Part No.	Anzahl der Zähne No. of teeth	Aus- führung Type	Material	d _d (mm)	d _a (mm)	D _B (mm)	b ₁ (mm)	B (mm)	D (mm)	Vor- bohrung Pilot bore d (mm)	Fertig- bohrung Finished bore d _{max} (mm)	Gewicht Weight (≈ kg)	€ Stück each
12-5M-15	12	6F	St	19,10	17,96	25	20,5	26	13,0	4	7	0,034	auf Anfrage on request
14-5M-15	14	6F	St	22,28	21,14	25	20,5	26	14,0	6	8	0,046	
15-5M-15	15	6F	St	23,87	22,73	28	20,5	26	16,0	6	10	0,056	
16-5M-15	16	6F	St	25,46	24,32	28	20,5	26	16,5	6	10	0,064	
18-5M-15	18	6F	St	28,65	27,51	32	20,5	26	20,0	6	12	0,086	
20-5M-15	20	6F	St	31,83	30,69	36	20,5	26	23,0	6	14	0,112	
21-5M-15	21	6F	St	33,42	32,28	38	20,5	26	24,0	6	14	0,130	
22-5M-15	22	6F	St	35,01	33,87	38	20,5	26	25,5	6	14	0,140	
24-5M-15	24	6F	St	38,20	37,06	42	20,5	28	27,0	6	16	0,180	
26-5M-15	26	6F	St	41,38	40,24	44	20,5	28	30,0	6	18	0,220	
28-5M-15	28	6F	St	44,56	43,42	48	20,5	28	30,5	6	18	0,250	
30-5M-15	30	6F	St	47,75	46,61	51	20,5	28	35,0	6	20	0,300	
32-5M-15	32	6F	St	50,93	49,79	54	20,5	28	38,0	8	22	0,350	
36-5M-15	36	6F	St	57,30	56,16	60	20,5	28	38,0	8	22	0,426	
40-5M-15	40	6F	St	63,66	62,52	71	20,5	28	38,0	8	22	0,520	
44-5M-15	44	6W	Al	70,03	68,89	—	20,5	30	38,0	8	22	0,225	
48-5M-15	48	6W	Al	76,39	75,25	—	20,5	30	38,0	8	25	0,187	
60-5M-15	60	6W	Al	95,49	94,35	—	20,5	30	50,0	8	25	0,305	
72-5M-15	72	6W	Al	114,59	113,45	—	20,5	30	50,0	8	25	0,375	

Type 5M – Teilung Pitch 5 mm für Riemenbreite for belt width 25 mm

12-5M-25	12	6F	St	19,10	17,96	25	30	36	13,0	4	7	0,050	auf Anfrage on request
14-5M-25	14	6F	St	22,28	21,14	25	30	36	14,0	6	8	0,070	
15-5M-25	15	6F	St	23,87	22,73	28	30	36	16,0	6	10	0,080	
16-5M-25	16	6F	St	25,46	24,32	28	30	36	16,5	6	10	0,100	
18-5M-25	18	6F	St	28,65	27,51	32	30	36	20,0	6	12	0,120	
20-5M-25	20	6F	St	31,83	30,69	36	30	36	23,0	6	14	0,160	
21-5M-25	21	6F	St	33,42	32,28	38	30	38	24,0	6	14	0,190	
22-5M-25	22	6F	St	35,01	33,87	38	30	38	25,5	6	14	0,210	
24-5M-25	24	6F	St	38,20	37,06	42	30	38	27,0	6	16	0,250	
26-5M-25	26	6F	St	41,38	40,24	44	30	38	30,0	6	18	0,300	
28-5M-25	28	6F	St	44,56	43,42	48	30	38	30,5	6	18	0,350	
30-5M-25	30	6F	St	47,75	46,61	51	30	38	35,0	6	20	0,420	
32-5M-25	32	6F	St	50,93	49,79	54	30	38	38,0	8	22	0,480	
36-5M-25	36	6F	St	57,30	56,16	60	30	38	38,0	8	22	0,590	
40-5M-25	40	6F	St	63,66	62,52	71	30	38	38,0	8	22	0,740	
44-5M-25	44	6W	Al	70,03	68,89	—	30	40	38,0	8	22	0,320	
48-5M-25	48	6W	Al	76,39	75,25	—	30	40	38,0	8	25	0,275	
60-5M-25	60	6W	Al	95,49	94,35	—	30	40	50,0	8	25	0,435	
72-5M-25	72	6W	Al	114,59	113,45	—	30	40	50,0	8	25	0,525	

St = Stahl Steel Al = Aluminium

Fertigungstechnische Änderungen vorbehalten. We reserve the right to make technical changes.

HTD®-Zahnscheiben für zylindrische Bohrung HTD® pulleys for plain boring

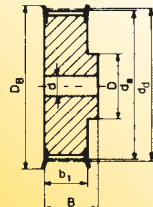

Ausf. Type 6F

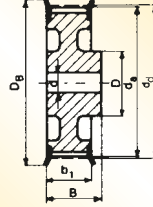

Ausf. Type 6WF

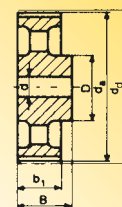

Ausf. Type 6A

Type 8M – Teilung Pitch 8 mm für Riemenbreite for belt width 20 mm

Bezeichnung Part No.	Anzahl der Zähne No. of teeth	Aus- führung Type	Material	d _d (mm)	d _s (mm)	D _B (mm)	b ₁ (mm)	B (mm)	D (mm)	D _i (mm)	Vor- bohrung Pilot bore d (mm)	Fertig- bohrung Finished bore d _{max} (mm)	Gewicht Weight (≈ kg)	€ Stück each
22-8M-20	22	6F	St	56,02	54,65	60,0	28	38	43	—	12	30	0,54	auf Anfrage on request
24-8M-20	24	6F	St	61,12	59,75	66,0	28	38	45	—	12	30	0,65	
26-8M-20	26	6F	St	66,21	64,84	71,0	28	38	50	—	12	35	0,80	
28-8M-20	28	6F	St	71,30	69,93	75,0	28	38	50	—	15	35	0,87	
30-8M-20	30	6F	St	76,39	75,02	83,0	28	38	55	—	15	35	1,02	
32-8M-20	32	6F	St	81,49	80,12	87,0	28	38	60	—	15	40	1,20	
34-8M-20	34	6F	St	86,58	85,22	91,0	28	38	70	—	15	45	1,40	
36-8M-20	36	6F	St	91,67	90,30	98,5	28	38	70	—	15	45	1,55	
38-8M-20	38	6F	St	96,77	95,39	103,0	28	38	75	—	15	45	1,65	
40-8M-20	40	6F	GG	101,86	100,49	106,0	28	38	75	—	15	45	1,80	
44-8M-20	44	6F	GG	112,05	110,67	119,0	28	38	75	—	15	45	2,10	
48-8M-20	48	6F	GG	122,23	120,86	127,0	28	38	75	—	15	45	2,44	
56-8M-20	56	6WF	GG	142,60	141,23	148,0	28	38	80	117	15	45	2,60	
64-8M-20	64	6WF	GG	162,97	161,60	168,0	28	38	80	137	15	45	2,90	
72-8M-20	72	6WF	GG	183,35	181,97	192,0	28	38	80	158	15	45	3,10	
80-8M-20	80	6A	GG	203,72	202,35	—	28	38	90	180	15	50	3,80	
90-8M-20	90	6A	GG	229,18	227,81	—	28	38	90	204	15	50	4,20	
112-8M-20	112	6A	GG	285,21	283,83	—	28	38	90	260	18	50	5,20	
144-8M-20	144	6A	GG	366,69	365,32	—	28	38	90	341	20	50	7,50	
168-8M-20	168	6A	GG	427,81	426,44	—	28	38	100	402	20	55	10,00	
192-8M-20	192	6A	GG	488,92	487,55	—	28	38	100	463	20	55	14,40	

Type 8M – Teilung Pitch 8 mm für Riemenbreite for belt width 30 mm

22-8M-30	22	6F	St	56,02	54,65	60,0	38	48	43	—	12	30	0,69	auf Anfrage on request
24-8M-30	24	6F	St	61,12	59,75	66,0	38	48	45	—	12	30	0,84	
26-8M-30	26	6F	St	66,21	64,84	71,0	38	48	50	—	12	35	1,00	
28-8M-30	28	6F	St	71,30	69,93	75,0	38	48	50	—	15	35	1,12	
30-8M-30	30	6F	St	76,39	75,02	83,0	38	48	55	—	15	35	1,32	
32-8M-30	32	6F	St	81,49	80,12	87,0	38	48	60	—	15	40	1,50	
34-8M-30	34	6F	St	86,58	85,22	91,0	38	48	70	—	15	45	1,80	
36-8M-30	36	6F	St	91,67	90,30	98,5	38	48	70	—	15	45	1,99	
38-8M-30	38	6F	St	96,77	95,39	103,0	38	48	75	—	15	45	2,27	
40-8M-30	40	6F	GG	101,86	100,49	106,0	38	48	75	—	15	45	2,40	
44-8M-30	44	6F	GG	112,05	110,67	119,0	38	48	75	—	15	45	2,80	
48-8M-30	48	6F	GG	122,23	120,86	127,0	38	48	75	—	15	45	3,20	
56-8M-30	56	6WF	GG	142,60	141,23	148,0	38	48	90	117	15	50	3,60	
64-8M-30	64	6WF	GG	162,97	161,60	168,0	38	48	90	137	15	50	4,30	
72-8M-30	72	6WF	GG	183,35	181,97	192,0	38	48	95	158	15	50	4,80	
80-8M-30	80	6A	GG	203,72	202,35	—	38	48	100	180	15	55	5,10	
90-8M-30	90	6A	GG	229,18	227,81	—	38	48	100	204	15	55	5,70	
112-8M-30	112	6A	GG	285,21	283,83	—	38	48	100	260	18	55	6,80	
144-8M-30	144	6A	GG	366,69	365,32	—	38	48	100	341	20	55	9,30	
168-8M-30	168	6A	GG	427,81	426,44	—	38	48	100	402	20	55	11,40	
192-8M-30	192	6A	GG	488,92	487,55	—	38	48	100	463	20	55	16,00	

HTD®-Zahnscheiben für zylindrische Bohrung HTD® pulleys for plain boring

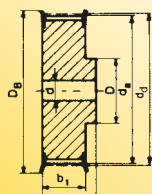

Ausf. Type 6F

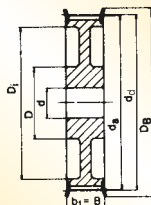

Ausf. Type 10WF

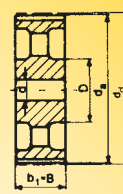

Ausf. Type 10A

Type 8M – Teilung Pitch 8 mm für Riemenbreite for belt width 50 mm

Bezeichnung Part No.	Anzahl der Zähne No. of teeth	Aus- führung Type	Material	d _d (mm)	d _s (mm)	D _B (mm)	b ₁ (mm)	B (mm)	D (mm)	D _i (mm)	Vor- bohrung Pilot bore d (mm)	Fertig- bohrung Finished bore d _{max} (mm)	Gewicht Weight (≈ kg)	€ Stück each
22-8M-50	22	6F	St	56,02	54,65	60,0	60	70	43	—	12	30	1,00	auf Anfrage on request
24-8M-50	24	6F	St	61,12	59,75	66,0	60	70	45	—	12	30	1,20	
26-8M-50	26	6F	St	66,21	64,84	71,0	60	70	50	—	12	35	1,50	
28-8M-50	28	6F	St	71,30	69,93	75,0	60	70	50	—	15	35	1,67	
30-8M-50	30	6F	St	76,39	75,02	83,0	60	70	55	—	15	35	1,97	
32-8M-50	32	6F	St	81,49	80,12	87,0	60	70	60	—	15	40	2,27	
34-8M-50	34	6F	St	86,58	85,22	91,0	60	70	70	—	15	45	2,69	
36-8M-50	36	6F	St	91,67	90,30	98,5	60	70	70	—	15	45	2,97	
38-8M-50	38	6F	St	96,77	95,39	103,0	60	70	75	—	15	45	3,23	
40-8M-50	40	6F	GG	101,86	100,49	106,0	60	70	75	—	18	45	3,50	
44-8M-50	44	6F	GG	112,05	110,67	119,0	60	70	75	—	18	45	3,90	
48-8M-50	48	6F	GG	122,23	120,86	127,0	60	70	80	—	18	45	4,30	
56-8M-50	56	10WF	GG	142,60	141,23	148,0	60	60	90	117	18	50	5,00	
64-8M-50	64	10WF	GG	162,97	161,60	168,0	60	60	100	137	18	55	5,60	
72-8M-50	72	10WF	GG	183,35	181,97	192,0	60	60	100	158	18	55	6,80	
80-8M-50	80	10A	GG	203,72	202,35	—	60	60	110	180	18	60	6,90	
90-8M-50	90	10A	GG	229,18	227,81	—	60	60	110	204	18	60	8,60	
112-8M-50	112	10A	GG	285,21	283,83	—	60	60	110	260	18	60	9,60	
144-8M-50	144	10A	GG	366,69	365,32	—	60	60	110	341	20	60	13,80	
168-8M-50	168	10A	GG	427,81	426,44	—	60	60	120	402	20	65	16,00	
192-8M-50	192	10A	GG	488,92	487,55	—	60	60	130	463	20	70	22,40	

Type 8M – Teilung Pitch 8 mm für Riemenbreite for belt width 85 mm

22-8M-85	22	6F	St	56,02	54,65	60,0	95	105	43	—	12	30	1,55	auf Anfrage on request
24-8M-85	24	6F	St	61,12	59,75	66,0	95	105	45	—	12	30	1,90	
26-8M-85	26	6F	St	66,21	64,84	71,0	95	105	50	—	12	35	2,25	
28-8M-85	28	6F	St	71,30	69,93	75,0	95	105	50	—	15	35	2,55	
30-8M-85	30	6F	St	76,39	75,02	83,0	95	105	55	—	15	35	3,00	
32-8M-85	32	6F	St	81,49	80,12	87,0	95	105	60	—	15	40	3,57	
34-8M-85	34	6F	St	86,58	85,22	91,0	95	105	70	—	15	45	4,00	
36-8M-85	36	6F	St	91,67	90,30	98,5	95	105	70	—	15	45	4,50	
38-8M-85	38	6F	St	96,77	95,39	103,0	95	105	75	—	15	45	4,90	
40-8M-85	40	6F	GG	101,86	100,49	106,0	95	105	75	—	18	45	5,20	
44-8M-85	44	6F	GG	112,05	110,67	119,0	95	105	75	—	18	45	6,60	
48-8M-85	48	6F	GG	122,23	120,86	127,0	95	105	80	—	18	45	7,60	
56-8M-85	56	6F	GG	142,60	141,23	148,0	95	105	80	—	20	50	9,80	
64-8M-85	64	10WF	GG	162,97	161,60	168,0	95	95	100	137	20	55	10,40	
72-8M-85	72	10WF	GG	183,35	181,97	192,0	95	95	110	158	20	60	11,40	
80-8M-85	80	10A	GG	203,72	202,35	—	95	95	110	180	20	60	11,10	
90-8M-85	90	10A	GG	229,18	227,81	—	95	95	110	204	20	60	13,20	
112-8M-85	112	10A	GG	285,21	283,83	—	95	95	110	260	24	60	16,30	
144-8M-85	144	10A	GG	366,69	365,32	—	95	95	120	341	24	65	21,50	
168-8M-85	168	10A	GG	427,81	426,44	—	95	95	120	402	24	65	26,10	
192-8M-85	192	10A	GG	488,92	487,55	—	95	95	130	463	24	70	30,60	

St = Stahl Steel GG = Grauguss Cast iron

Fertigungstechnische Änderungen vorbehalten. We reserve the right to make technical changes.

HTD®-Zahnscheiben für zylindrische Bohrung HTD® pulleys for plain boring

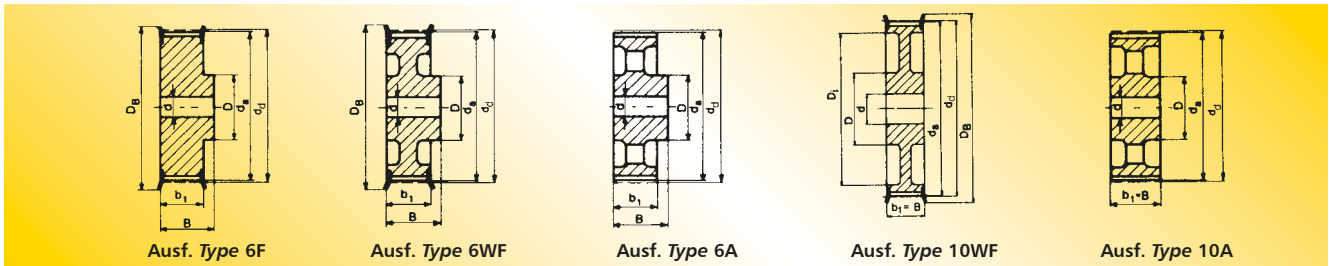

Type 14M – Teilung *Pitch* 14 mm für Riemenbreite *for belt width* 40 mm

Bezeichnung Part No.	Anzahl der Zähne No. of teeth	Aus- führung Type	Material	d _d (mm)	d _s (mm)	D _B (mm)	b ₁ (mm)	B (mm)	D (mm)	D _i (mm)	Vor- bohrung Pilot bore d (mm)	Fertig- bohrung Finished bore d _{max} (mm)	Gewicht Weight (≈ kg)	€ Stück each
28-14M-40	28	6F	GG	124,78	122,12	127	54	69	100	—	24	60	4,73	auf Anfrage on request
29-14M-40	29	6F	GG	129,23	126,57	138	54	69	100	—	24	60	5,09	
30-14M-40	30	6F	GG	133,69	130,99	138	54	69	100	—	24	60	5,45	
32-14M-40	32	6F	GG	142,60	139,88	154	54	69	100	—	24	70	6,17	
34-14M-40	34	6F	GG	151,52	148,79	160	54	69	100	—	24	70	6,88	
36-14M-40	36	6F	GG	160,43	157,68	168	54	69	100	—	24	70	7,60	
38-14M-40	38	6F	GG	169,34	166,60	183	54	69	120	—	24	70	8,28	
40-14M-40	40	6F	GG	178,25	175,49	188	54	69	120	—	24	70	9,26	
44-14M-40	44	6F	GG	196,08	193,28	211	54	69	120	—	24	70	10,32	
48-14M-40	48	6WF	GG	213,90	211,11	226	54	69	135	172	24	70	11,50	
56-14M-40	56	6WF	GG	249,55	246,76	256	54	69	135	207	28	70	13,05	
64-14M-40	64	6WF	GG	285,21	282,41	296	54	69	135	242	28	70	14,40	
72-14M-40	72	6A	GG	320,86	318,06	—	54	69	135	278	28	70	16,90	
80-14M-40	80	6A	GG	356,51	353,71	—	54	69	135	314	28	70	18,50	
90-14M-40	90	6A	GG	401,07	398,28	—	54	69	135	358	28	70	20,00	
112-14M-40	112	6A	GG	499,11	496,32	—	54	69	135	456	28	70	26,70	
144-14M-40	144	6A	GG	641,71	638,92	—	54	69	135	600	28	70	35,00	
168-14M-40	168	6A	GG	748,66	745,87	—	54	69	135	706	28	70	44,20	
192-14M-40	192	6A	GG	855,62	852,82	—	54	69	135	813	28	70	52,20	
216-14M-40	216	6A	GG	962,57	959,77	—	54	69	150	920	28	80	60,00	

Type 14M – Teilung *Pitch* 14 mm für Riemenbreite *for belt width* 55 mm

28-14M-55	28	6F	GG	124,78	122,12	127	70	85	100	—	24	60	5,60	auf Anfrage on request
29-14M-55	29	6F	GG	129,23	126,57	138	70	85	100	—	24	60	6,10	
30-14M-55	30	6F	GG	133,69	130,99	138	70	85	100	—	24	60	6,60	
32-14M-55	32	6F	GG	142,60	139,88	154	70	85	100	—	24	70	7,60	
34-14M-55	34	6F	GG	151,52	148,79	160	70	85	100	—	24	70	8,60	
36-14M-55	36	6F	GG	160,43	157,68	168	70	85	100	—	24	70	9,60	
38-14M-55	38	6F	GG	169,34	166,60	183	70	85	120	—	24	70	10,80	
40-14M-55	40	6F	GG	178,25	175,49	188	70	85	120	—	24	70	11,20	
44-14M-55	44	6F	GG	196,08	193,28	211	70	85	120	—	24	70	12,50	
48-14M-55	48	10WF	GG	213,90	211,11	226	70	70	135	172	24	70	13,70	
56-14M-55	56	10WF	GG	249,55	246,76	256	70	70	135	207	28	70	14,50	
64-14M-55	64	10WF	GG	285,21	282,41	296	70	70	135	242	28	70	15,60	
72-14M-55	72	10A	GG	320,86	318,06	—	70	70	135	278	28	70	18,50	
80-14M-55	80	10A	GG	356,51	353,71	—	70	70	135	314	28	70	20,00	
90-14M-55	90	10A	GG	401,07	398,28	—	70	70	135	358	28	70	22,60	
112-14M-55	112	10A	GG	499,11	496,32	—	70	70	135	456	28	70	29,50	
144-14M-55	144	10A	GG	641,71	638,92	—	70	70	135	600	28	70	39,00	
168-14M-55	168	10A	GG	748,66	745,87	—	70	70	135	706	28	70	48,50	
192-14M-55	192	10A	GG	855,62	852,82	—	70	70	135	813	28	70	57,80	
216-14M-55	216	10A	GG	962,57	959,77	—	70	70	150	920	28	80	67,00	

GG = Grauguss Cast iron

Fertigungstechnische Änderungen vorbehalten. We reserve the right to make technical changes.

HTD®-Zahnscheiben für zylindrische Bohrung HTD® pulleys for plain boring

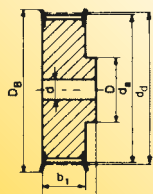

Ausf. Type 6F

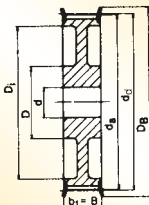

Ausf. Type 10WF

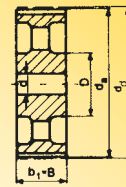

Ausf. Type 10A

Type 14M – Teilung Pitch 14 mm für Riemenbreite for belt width 85 mm

Bezeichnung Part No.	Anzahl der Zähne No. of teeth	Aus- führung Type	Material	d _d (mm)	d _s (mm)	D _B (mm)	b ₁ (mm)	B (mm)	D (mm)	D _i (mm)	Vor- bohrung Pilot bore d (mm)	Fertig- bohrung Finished bore d _{max} (mm)	Gewicht Weight (≈ kg)	€ Stück each
28-14M-85	28	6F	GG	124,78	122,12	127	102	117	100	—	24	60	7,70	auf Anfrage on request
29-14M-85	29	6F	GG	129,23	126,57	138	102	117	100	—	24	60	8,40	
30-14M-85	30	6F	GG	133,69	130,99	138	102	117	100	—	24	60	9,10	
32-14M-85	32	6F	GG	142,60	139,88	154	102	117	100	—	24	60	10,50	
34-14M-85	34	6F	GG	151,52	148,79	160	102	117	100	—	24	70	11,90	
36-14M-85	36	6F	GG	160,43	157,68	168	102	117	100	—	32	70	13,20	
38-14M-85	38	6F	GG	169,34	166,60	183	102	117	120	—	32	70	15,15	
40-14M-85	40	6F	GG	178,25	175,49	188	102	117	135	—	32	70	17,10	
44-14M-85	44	6F	GG	196,08	193,28	211	102	117	135	—	32	70	23,30	
48-14M-85	48	6F	GG	213,90	211,11	226	102	117	150	—	32	80	25,00	
56-14M-85	56	10WF	GG	249,55	246,76	256	102	102	150	207	32	80	25,00	
64-14M-85	64	10WF	GG	285,21	282,41	296	102	102	150	242	32	80	28,20	
72-14M-85	72	10A	GG	320,86	318,06	—	102	102	150	278	32	80	28,80	
80-14M-85	80	10A	GG	356,51	353,71	—	102	102	150	314	32	80	30,10	
90-14M-85	90	10A	GG	401,07	398,28	—	102	102	150	358	32	80	33,00	
112-14M-85	112	10A	GG	499,11	496,32	—	102	102	150	456	32	80	41,80	
144-14M-85	144	10A	GG	641,71	638,92	—	102	102	150	600	32	80	52,40	
168-14M-85	168	10A	GG	748,66	745,87	—	102	102	150	706	32	80	60,30	
192-14M-85	192	10A	GG	855,62	852,82	—	102	102	165	813	32	90	70,20	
216-14M-85	216	10A	GG	962,57	959,77	—	102	102	165	920	32	90	81,00	

Type 14M – Teilung Pitch 14 mm für Riemenbreite for belt width 115 mm

28-14M-115	28	6F	GG	124,78	122,12	127	133	148	100	—	32	60	9,20	auf Anfrage on request
29-14M-115	29	6F	GG	129,23	126,57	138	133	148	100	—	32	60	10,20	
30-14M-115	30	6F	GG	133,69	130,99	138	133	148	100	—	32	60	11,20	
32-14M-115	32	6F	GG	142,60	139,88	154	133	148	100	—	32	60	13,20	
34-14M-115	34	6F	GG	151,52	148,79	160	133	148	100	—	32	70	14,80	
36-14M-115	36	6F	GG	160,43	157,68	168	133	148	120	—	32	70	16,60	
38-14M-115	38	6F	GG	169,34	166,60	183	133	148	120	—	32	70	19,20	
40-14M-115	40	6F	GG	178,25	175,49	188	133	148	135	—	32	70	22,10	
44-14M-115	44	6F	GG	196,08	193,28	211	133	148	140	—	32	80	28,00	
48-14M-115	48	6F	GG	213,90	211,11	226	133	148	150	—	32	80	35,00	
56-14M-115	56	6F	GG	249,55	246,76	256	133	148	150	—	32	80	44,20	
64-14M-115	64	10WF	GG	285,21	282,41	296	133	133	150	242	32	80	36,80	
72-14M-115	72	10A	GG	320,86	318,06	—	133	133	150	278	32	80	36,10	
80-14M-115	80	10A	GG	356,51	353,71	—	133	133	150	314	32	80	38,60	
90-14M-115	90	10A	GG	401,07	398,28	—	133	133	150	358	32	80	41,00	
112-14M-115	112	10A	GG	499,11	496,32	—	133	133	150	456	32	80	54,40	
144-14M-115	144	10A	GG	641,71	638,92	—	133	133	165	600	32	90	67,80	
168-14M-115	168	10A	GG	748,66	745,87	—	133	133	165	706	32	90	75,80	
192-14M-115	192	10A	GG	855,62	852,82	—	133	133	165	813	32	90	88,30	
216-14M-115	216	10A	GG	962,57	959,77	—	133	133	165	920	32	90	98,00	

GG = Grauguss Cast iron

Fertigungstechnische Änderungen vorbehalten. We reserve the right to make technical changes.

HTD®-Zahnscheiben für zylindrische Bohrung HTD® pulleys for plain boring

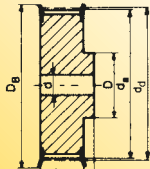

Ausf. Type 6F

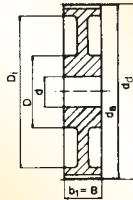

Ausf. Type 10W

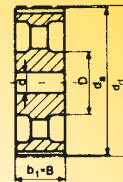

Ausf. Type 10A

Type 14M – Teilung Pitch 14 mm für Riemenbreite for belt width 170 mm

Bezeichnung Part No.	Anzahl der Zähne No. of teeth	Aus- führung Type	Material	d_d (mm)	d_s (mm)	D_B (mm)	b_1 (mm)	B (mm)	D (mm)	D_1 (mm)	Vor- bohrung Pilot bore d (mm)	Fertig- bohrung Finished bore d_{max} (mm)	Gewicht Weight (≈ kg)	€ Stück each
28-14M-170	28	6F	GG	124,78	122,12	127	187	202	100	—	32	60	13,80	auf Anfrage on request
29-14M-170	29	6F	GG	129,23	126,57	138	187	202	100	—	32	60	14,20	
30-14M-170	30	6F	GG	133,69	130,99	138	187	202	100	—	32	60	15,60	
32-14M-170	32	6F	GG	142,60	139,88	154	187	202	100	—	32	60	18,10	
34-14M-170	34	6F	GG	151,52	148,79	160	187	202	100	—	32	60	20,40	
36-14M-170	36	6F	GG	160,43	157,68	168	187	202	120	—	32	70	23,50	
38-14M-170	38	6F	GG	169,34	166,60	183	187	202	135	—	32	70	26,50	
40-14M-170	40	6F	GG	178,25	175,49	188	187	202	140	—	32	85	30,10	
44-14M-170	44	6F	GG	196,08	193,28	211	187	202	160	—	32	85	37,80	
48-14M-170	48	6F	GG	213,90	211,11	226	187	202	160	—	32	85	44,50	
56-14M-170	56	6F	GG	249,55	246,76	256	187	202	160	—	32	85	61,00	
64-14M-170	64	6F	GG	285,21	282,41	296	187	202	180	—	32	100	81,00	
72-14M-170	72	10W	GG	320,86	318,06	—	187	187	180	278	32	100	61,40	
80-14M-170	80	10W	GG	356,51	353,71	—	187	187	180	314	32	100	65,00	
90-14M-170	90	10A	GG	401,07	398,28	—	187	187	180	358	38	100	68,00	
112-14M-170	112	10A	GG	499,11	496,32	—	187	187	200	456	38	110	87,50	
144-14M-170	144	10A	GG	641,71	638,92	—	187	187	220	600	38	120	114,80	
168-14M-170	168	10A	GG	748,66	745,87	—	187	187	220	706	38	120	125,00	
192-14M-170	192	10A	GG	855,62	852,82	—	187	187	220	813	38	120	136,40	
216-14M-170	216	10A	GG	962,57	959,77	—	187	187	220	920	38	120	147,00	



HTD®-Zahnscheiben Type 20M auf Anfrage HTD® pulleys type 20M on request

GG = Grauguss Cast iron

Fertigungstechnische Änderungen vorbehalten. We reserve the right to make technical changes.

HTD®-Zahnscheiben für Taperbuchsen HTD® pulleys for taper bushes

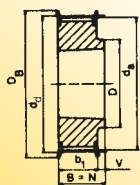

Ausf. Type 8F

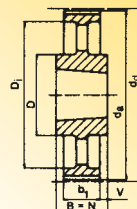

Ausf. Type 7A

Type 5M – Teilung Pitch 5 mm für Riemenbreite for belt width 15 mm

Bezeichnung Part No.	Anzahl der Zähne No. of teeth	Aus- führung Type	Material	d_d (mm)	d_s (mm)	D_B (mm)	b_1 (mm)	B (mm)	N (mm)	V (mm)	Z (mm)	D (mm)	D_i (mm)	Taper- Buchse Taper bush	Gewicht ohne Buchse Weight without bush (≈ kg)	€ Stück ohne Buchse each without bush
TB 34-5M-15	34	8F	St	54,11	52,97	57,0	20,5	22	22	1,5	—	43	—	1008	0,190	auf Anfrage on request
TB 36-5M-15	36	8F	St	57,30	56,16	60,0	20,5	22	22	1,5	—	44	—	1108	0,200	
TB 38-5M-15	38	8F	St	60,48	59,34	66,0	20,5	22	22	1,5	—	48	—	1108	0,250	
TB 40-5M-15	40	8F	St	63,66	62,52	71,0	20,5	22	22	1,5	—	52	—	1108	0,310	
TB 44-5M-15	44	8F	St	70,03	68,89	75,0	20,5	22	22	1,5	—	54	—	1108	0,400	
TB 48-5M-15	48	8F	St	76,39	75,25	83,0	20,5	25	25	4,5	—	64	—	1210	0,450	
TB 56-5M-15	56	8F	GG	89,13	87,99	93,0	20,5	25	25	4,5	—	70	—	1210	0,670	
TB 64-5M-15	64	8F	GG	101,86	100,72	106,0	20,5	25	25	4,5	—	78	—	1210	0,960	
TB 72-5M-15	72	8F	GG	114,59	113,45	119,0	20,5	25	25	4,5	—	90	—	1610	1,190	
TB 80-5M-15	80	8F	GG	127,32	126,18	135,0	20,5	25	25	4,5	—	92	—	1610	1,570	
TB 90-5M-15	90	7A	GG	143,24	142,10	—	20,5	25	25	2,3	—	92	—	1610	1,147	
TB 112-5M-15	112	7A	GG	178,25	177,11	—	20,5	25	25	2,3	—	92	—	1610	1,940	
TB 136-5M-15	136	7A	GG	216,45	215,31	—	20,5	32	32	5,8	—	106	—	2012	3,060	
TB 150-5M-15	150	7A	GG	238,73	237,59	—	20,5	32	32	5,8	—	106	—	2012	3,900	

54

Taperbuchse Taper bush	1008	1108	1210	1610	2012
Bohrung d_2 (mm) von ... bis ... Bore d_2 (mm) from ... to ...	10-25	10-28	11-32	14-42	14-50
€/Stück each	auf Anfrage / on request				

St = Stahl Steel
GG = Grauguss Cast iron
Fertigungstechnische Änderungen vorbehalten.
We reserve the right to make technical changes.
Bohrungsdurchmesser d_2 siehe Seite 3-4.
Bore diameters d_2 see page 3-4.

HTD®-Zahnscheiben für Taperbuchsen HTD® pulleys for taper bushes

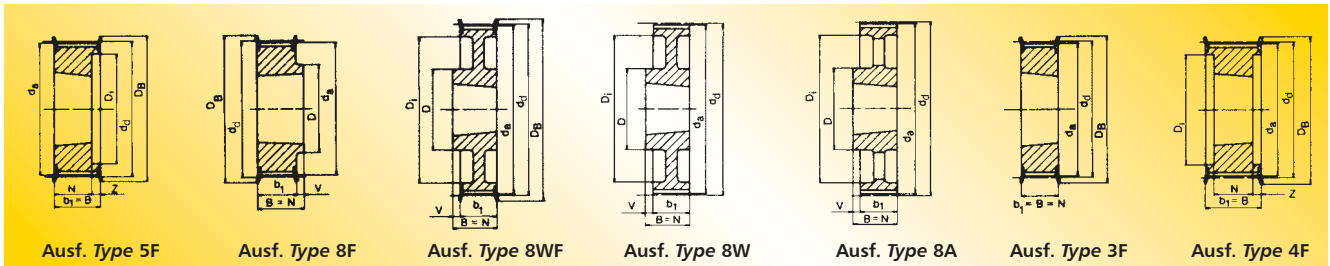

Type 8M – Teilung Pitch 8 mm für Riemenbreite for belt width 20 mm

Bezeichnung Part No.	Anzahl der Zähne No. of teeth	Ausführung Type	Material	d_d (mm)	d_s (mm)	D_B (mm)	b_1 (mm)	B (mm)	N (mm)	V (mm)	Z (mm)	D (mm)	D_i (mm)	Taper-Buchse Taper bush	Gewicht ohne Buchse Weight without bush (= kg)	€ Stück ohne Buchse each without bush
TB 22-8M-20	22	5F	GG	56,02	54,65	60,0	28	28	22	—	6	—	41	1008	0,24	auf Anfrage on request
TB 24-8M-20	24	5F	GG	61,12	59,75	66,0	28	28	22	—	6	—	42	1108	0,30	
TB 26-8M-20	26	5F	GG	66,21	64,84	71,0	28	28	22	—	6	—	46	1108	0,36	
TB 28-8M-20	28	5F	GG	71,30	69,93	75,0	28	28	22	—	6	—	50	1108	0,44	
TB 30-8M-20	30	5F	GG	76,39	75,02	83,0	28	28	22	—	6	—	58	1108	0,53	
TB 32-8M-20	32	5F	GG	81,49	80,12	87,0	28	28	25	—	3	—	62	1610	0,42	
TB 34-8M-20	34	5F	GG	86,58	85,22	91,0	28	28	25	—	3	—	65	1610	0,55	
TB 36-8M-20	36	5F	GG	91,67	90,30	98,5	28	28	25	—	3	—	68	1610	0,68	
TB 38-8M-20	38	5F	GG	96,77	95,39	103,0	28	28	25	—	3	—	72	1610	0,80	
TB 40-8M-20	40	5F	GG	101,86	100,49	106,0	28	28	25	—	3	—	76	1610	1,00	
TB 44-8M-20	44	8F	GG	112,05	110,67	119,0	28	32	32	4	—	93	—	2012	1,20	
TB 48-8M-20	48	8F	GG	122,23	120,86	127,0	28	32	32	4	—	96	—	2012	1,60	
TB 56-8M-20	56	8F	GG	142,60	141,23	148,0	28	32	32	4	—	110	—	2012	2,40	
TB 64-8M-20	64	8WF	GG	162,97	161,60	168,0	28	32	32	4	—	110	137	2012	2,70	
TB 72-8M-20	72	8WF	GG	183,35	181,97	192,0	28	32	32	4	—	110	158	2012	3,30	
TB 80-8M-20	80	8W	GG	203,72	202,35	—	28	32	32	4	—	110	180	2012	3,50	
TB 90-8M-20	90	8A	GG	229,18	227,81	—	28	32	32	4	—	110	204	2012	3,65	

Type 8M – Teilung Pitch 8 mm für Riemenbreite for belt width 30 mm

TB 22-8M-30	22	5F	GG	56,02	54,65	60,0	38	38	22	—	16	—	41	1008	0,29	auf Anfrage on request
TB 24-8M-30	24	5F	GG	61,12	59,75	66,0	38	38	22	—	16	—	42	1108	0,38	
TB 26-8M-30	26	5F	GG	66,21	64,84	71,0	38	38	22	—	16	—	46	1108	0,45	
TB 28-8M-30	28	5F	St	71,30	69,93	75,0	38	38	25	—	13	—	50	1210	0,50	
TB 30-8M-30	30	3F	St	76,39	75,02	83,0	38	38	38	—	—	—	—	1615	0,45	
TB 32-8M-30	32	3F	GG	81,49	80,12	87,0	38	38	38	—	—	—	—	1615	0,59	
TB 34-8M-30	34	3F	GG	86,58	85,22	91,0	38	38	38	—	—	—	—	1615	0,77	
TB 36-8M-30	36	3F	GG	91,67	90,30	98,5	38	38	38	—	—	—	—	1615	0,96	
TB 38-8M-30	38	3F	GG	96,77	95,39	103,0	38	38	38	—	—	—	—	1615	1,15	
TB 40-8M-30	40	3F	GG	101,86	100,49	106,0	38	38	38	—	—	—	—	1615	1,34	
TB 44-8M-30	44	4F	GG	112,05	110,67	119,0	38	38	32	—	3	—	91	2012	1,33	
TB 48-8M-30	48	4F	GG	122,23	120,86	127,0	38	38	32	—	3	—	95	2012	1,78	
TB 56-8M-30	56	4F	GG	142,60	141,23	148,0	38	38	32	—	3	—	117	2012	3,76	
TB 64-8M-30	64	8F	GG	162,97	161,60	168,0	38	45	45	7	—	125	—	2517	4,20	
TB 72-8M-30	72	8WF	GG	183,35	181,97	192,0	38	45	45	7	—	125	158	2517	4,30	
TB 80-8M-30	80	8W	GG	203,72	202,35	—	38	45	45	7	—	125	180	2517	4,60	
TB 90-8M-30	90	8A	GG	229,18	227,81	—	38	45	45	7	—	125	204	2517	5,00	
TB 112-8M-30	112	8A	GG	285,21	283,83	—	38	45	45	7	—	125	260	2517	6,20	
TB 144-8M-30	144	8A	GG	366,69	365,32	—	38	45	45	7	—	125	341	2517	9,00	

Taperbuchse Taper bush	1008	1108	1210	1610	1615	2012	2517
Bohrung d_2 (mm) von ... bis ... Bore d_2 (mm) from ... to ...	10-25	10-28	11-32	14-42	14-42	14-50	16-60
€/Stück each	auf Anfrage / on request						

GG = Grauguss Cast iron
St = Stahl Steel
Fertigungstechnische Änderungen vorbehalten.
We reserve the right to make technical changes.
Bohrungsdurchmesser d_2 siehe Seite 3-4.
Bore diameters d_2 see page 3-4.

HTD®-Zahnscheiben für Taperbuchsen HTD® pulleys for taper bushes

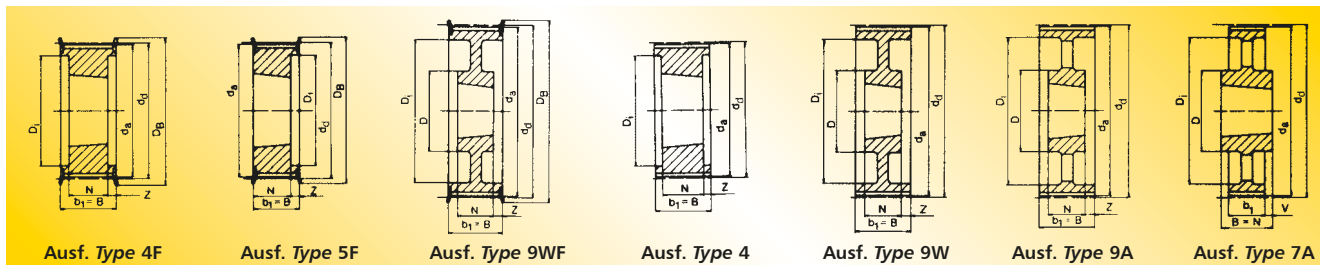

Type 8M – Teilung Pitch 8 mm für Riemenbreite for belt width 50 mm

Bezeichnung Part No.	Anzahl der Zähne No. of teeth	Aus- führung Type	Material	d_d (mm)	d_s (mm)	D_B (mm)	b_1 (mm)	B (mm)	N (mm)	V (mm)	Z (mm)	D (mm)	D_i (mm)	Taper- Buchse Taper bush	Gewicht ohne Buchse Weight without bush (≈ kg)	€ Stück ohne Buchse each without bush
TB 28-8M-50	28	5F	St	71,30	69,93	75,0	60	60	25	—	35,0	—	50	1210	0,60	auf Anfrage on request
TB 30-8M-50	30	5F	St	76,39	75,02	83,0	60	60	38	—	22,0	—	58	1615	0,65	
TB 32-8M-50	32	5F	GG	81,49	80,12	87,0	60	60	38	—	22,0	—	62	1615	0,82	
TB 34-8M-50	34	5F	GG	86,58	85,22	91,0	60	60	38	—	22,0	—	65	1615	1,06	
TB 36-8M-50	36	5F	GG	91,67	90,30	98,5	60	60	38	—	22,0	—	68	1615	1,30	
TB 38-8M-50	38	5F	GG	96,77	95,39	103,0	60	60	38	—	22,0	—	72	1615	1,60	
TB 40-8M-50	40	4F	GG	101,86	100,49	106,0	60	60	32	—	14,0	—	82	2012	1,71	
TB 44-8M-50	44	4F	GG	112,05	110,67	119,0	60	60	32	—	14,0	—	91	2012	1,78	
TB 48-8M-50	48	4F	GG	122,23	120,86	127,0	60	60	32	—	14,0	—	95	2012	2,30	
TB 56-8M-50	56	4F	GG	142,60	141,23	148,0	60	60	45	—	7,5	—	116	2517	3,40	
TB 64-8M-50	64	4F	GG	162,97	161,60	168,0	60	60	45	—	7,5	—	137	2517	5,00	
TB 72-8M-50	72	9WF	GG	183,35	181,97	192,0	60	60	45	—	7,5	125	158	2517	6,70	
TB 80-8M-50	80	4	GG	203,72	202,35	—	60	60	51	—	4,5	—	180	3020	8,80	
TB 90-8M-50	90	9W	GG	229,18	227,81	—	60	60	51	—	4,5	170	204	3020	10,00	
TB 112-8M-50	112	9W	GG	285,21	283,83	—	60	60	51	—	4,5	170	260	3020	12,00	
TB 144-8M-50	144	9A	GG	366,69	365,32	—	60	60	51	—	4,5	170	341	3020	15,20	
TB 168-8M-50	168	7A	GG	427,81	426,44	—	60	65	65	—	2,5	170	402	3525	16,40	
TB 192-8M-50	192	7A	GG	488,92	487,55	—	60	65	65	—	2,5	170	460	3525	21,80	

Type 8M – Teilung Pitch 8 mm für Riemenbreite for belt width 85 mm

TB 34-8M-85	34	4F	GG	86,58	85,22	91,0	95	95	38	—	28,5	—	65	1615	1,43	auf Anfrage on request
TB 36-8M-85	36	4F	GG	91,67	90,30	98,5	95	95	38	—	28,5	—	68	1615	1,87	
TB 38-8M-85	38	4F	GG	96,77	95,39	103,0	95	95	38	—	28,5	—	72	1615	2,20	
TB 40-8M-85	40	4F	GG	101,86	100,49	106,0	95	95	32	—	31,5	—	82	2012	1,78	
TB 44-8M-85	44	4F	GG	112,05	110,67	119,0	95	95	32	—	31,5	—	91	2012	2,30	
TB 48-8M-85	48	4F	GG	122,23	120,86	127,0	95	95	45	—	25,0	—	100	2517	2,66	
TB 56-8M-85	56	4F	GG	142,60	141,23	148,0	95	95	45	—	25,0	—	117	2517	4,45	
TB 64-8M-85	64	4F	GG	162,97	161,60	168,0	95	95	45	—	25,0	—	137	2517	6,20	
TB 72-8M-85	72	4F	GG	183,35	181,97	192,0	95	95	51	—	22,0	—	158	3020	8,00	
TB 80-8M-85	80	4	GG	203,72	202,35	—	95	95	51	—	22,0	—	180	3020	10,00	
TB 90-8M-85	90	9W	GG	229,18	227,81	—	95	95	51	—	22,0	170	204	3020	10,80	
TB 112-8M-85	112	9W	GG	285,21	283,83	—	95	95	51	—	22,0	170	260	3020	15,00	
TB 144-8M-85	144	9A	GG	366,69	365,32	—	95	95	76	—	15,0	170	341	3525	20,00	
TB 168-8M-85	168	9A	GG	427,81	426,44	—	95	95	76	—	15,0	170	402	3525	23,00	
TB 192-8M-85	192	9A	GG	488,92	487,55	—	95	95	76	—	15,0	170	460	3525	28,50	

Taperbuchse Taper bush	1210	1615	2012	2517	3020	3525
Bohrung d_2 (mm) von ... bis ... Bore d_2 (mm) from ... to ...	11-32	14-42	14-50	16-60	25-75	35-90
€/Stück each	auf Anfrage / on request					

GG = Grauguss Cast iron
St = Stahl Steel
Fertigungstechnische Änderungen vorbehalten.
We reserve the right to make technical changes.
Bohrungsdurchmesser d_2 siehe Seite 3-4.
Bore diameters d_2 see page 3-4.

HTD®-Zahnscheiben für Taperbuchsen HTD® pulleys for taper bushes

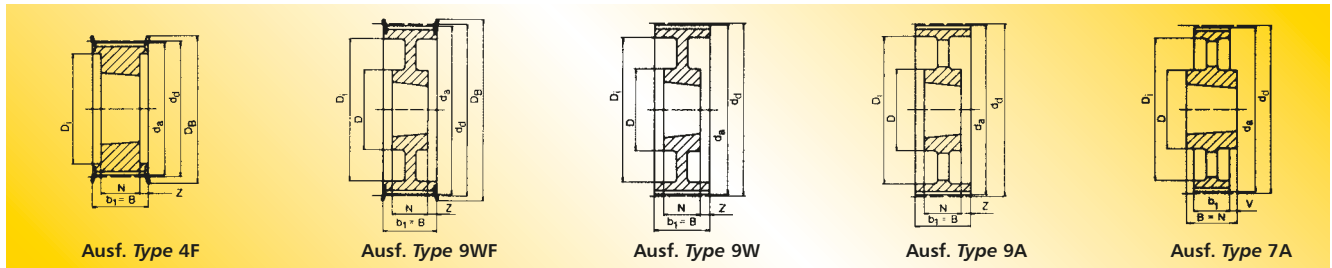

Type 14M – Teilung Pitch 14 mm für Riemenbreite for belt width 40 mm

Bezeichnung Part No.	Anzahl der Zähne No. of teeth	Aus- führung Type	Material	d _d (mm)	d _s (mm)	D _B (mm)	b ₁ (mm)	B (mm)	N (mm)	V (mm)	Z (mm)	D (mm)	D _i (mm)	Taper- Buchse Taper bush	Gewicht ohne Buchse Weight without bush (= kg)	€ Stück ohne Buchse each without bush
TB 28-14M-40	28	4F	GG	124,78	122,12	127	54	54	32	—	11,0	—	98	2012	2,00	auf Anfrage on request
TB 29-14M-40	29	4F	GG	129,23	126,57	138	54	54	32	—	11,0	—	100	2012	2,38	
TB 30-14M-40	30	4F	GG	133,69	130,99	138	54	54	32	—	11,0	—	100	2012	2,65	
TB 32-14M-40	32	4F	GG	142,60	139,88	154	54	54	32	—	11,0	—	104	2012	3,40	
TB 34-14M-40	34	4F	GG	151,52	148,79	160	54	54	45	—	4,5	—	110	2517	3,87	
TB 36-14M-40	36	4F	GG	160,43	157,68	168	54	54	45	—	4,5	—	120	2517	4,80	
TB 38-14M-40	38	4F	GG	169,34	166,60	183	54	54	45	—	4,5	—	130	2517	5,40	
TB 40-14M-40	40	4F	GG	178,25	175,49	188	54	54	45	—	4,5	—	138	2517	6,00	
TB 44-14M-40	44	4F	GG	196,08	193,28	211	54	54	51	—	1,5	—	155	3020	7,80	
TB 48-14M-40	48	4F	GG	213,90	211,11	226	54	54	51	—	1,5	—	170	3020	9,40	
TB 56-14M-40	56	9WF	GG	249,55	246,76	256	54	54	51	—	1,5	170	208	3020	10,80	
TB 64-14M-40	64	9WF	GG	285,21	282,41	296	54	54	51	—	1,5	170	242	3020	13,40	
TB 72-14M-40	72	9W	GG	320,86	318,06	—	54	54	51	—	1,5	170	280	3020	15,20	
TB 80-14M-40	80	9A	GG	356,51	353,71	—	54	54	51	—	1,5	170	315	3020	16,00	
TB 90-14M-40	90	9A	GG	401,07	398,28	—	54	54	51	—	1,5	170	360	3020	17,80	
TB 112-14M-40	112	9A	GG	499,11	496,32	—	54	54	51	—	1,5	170	457	3020	25,60	
TB 144-14M-40	144	9A	GG	641,71	638,92	—	54	54	51	—	1,5	170	600	3020	32,00	
TB 168-14M-40	168	9A	GG	748,66	745,87	—	54	54	51	—	1,5	170	706	3020	44,00	
TB 192-14M-40	192	9A	GG	855,62	852,82	—	54	54	51	—	1,5	170	813	3020	49,00	
TB 216-14M-40	216	9A	GG	962,57	959,77	—	54	54	51	—	1,5	170	920	3020	55,00	

Type 14M – Teilung Pitch 14 mm für Riemenbreite for belt width 55 mm

TB 28-14M-55	28	4F	GG	124,78	122,12	127	70	70	32	—	19,0	—	98	2012	2,20	auf Anfrage on request
TB 29-14M-55	29	4F	GG	129,23	126,57	138	70	70	32	—	19,0	—	100	2012	2,74	
TB 30-14M-55	30	4F	GG	133,69	130,99	138	70	70	45	—	12,5	—	100	2517	2,70	
TB 32-14M-55	32	4F	GG	142,60	139,88	154	70	70	45	—	12,5	—	108	2517	3,66	
TB 34-14M-55	34	4F	GG	151,52	148,79	160	70	70	45	—	12,5	—	110	2517	4,55	
TB 36-14M-55	36	4F	GG	160,43	157,68	168	70	70	45	—	12,5	—	120	2517	5,20	
TB 38-14M-55	38	4F	GG	169,34	166,60	183	70	70	45	—	12,5	—	130	2517	6,20	
TB 40-14M-55	40	4F	GG	178,25	175,49	188	70	70	45	—	12,5	—	138	2517	7,00	
TB 44-14M-55	44	4F	GG	196,08	193,28	211	70	70	51	—	9,5	—	155	3020	8,60	
TB 48-14M-55	48	4F	GG	213,90	211,11	226	70	70	51	—	9,5	—	170	3020	10,40	
TB 56-14M-55	56	9WF	GG	249,55	246,76	256	70	70	51	—	9,5	170	208	3020	12,00	
TB 64-14M-55	64	9WF	GG	285,21	282,41	296	70	70	51	—	9,5	170	242	3020	14,50	
TB 72-14M-55	72	9W	GG	320,86	318,06	—	70	70	51	—	9,5	170	280	3020	16,20	
TB 80-14M-55	80	9A	GG	356,51	353,71	—	70	70	51	—	9,5	170	315	3020	17,50	
TB 90-14M-55	90	9A	GG	401,07	398,28	—	70	70	51	—	9,5	170	360	3020	20,10	
TB 112-14M-55	112	9A	GG	499,11	496,32	—	70	70	51	—	9,5	170	457	3020	28,40	
TB 144-14M-55	144	9A	GG	641,71	638,92	—	70	70	51	—	9,5	170	600	3020	36,20	
TB 168-14M-55	168	9A	GG	748,66	745,87	—	70	70	51	—	9,5	170	706	3020	49,00	
TB 192-14M-55	192	9A	GG	855,62	852,82	—	70	70	51	—	9,5	170	813	3020	53,00	
TB 216-14M-55	216	7A	GG	962,57	959,77	—	70	89	89	9,5	—	190	920	3535	65,80	

Taperbuchse Taper bush	2012	2517	3020	3535
Bohrung d ₂ (mm) von ... bis ... Bore d ₂ (mm) from ... to ...	14-50	16-60	25-75	35-90
€/Stück each	auf Anfrage / on request			

GG = Grauguss Cast iron
Fertigungstechnische Änderungen vorbehalten.
We reserve the right to make technical changes.

Bohrungsdurchmesser d₂ siehe Seite 3-4.
Bore diameters d₂ see page 3-4.

HTD®-Zahnscheiben für Taperbuchsen HTD® pulleys for taper bushes

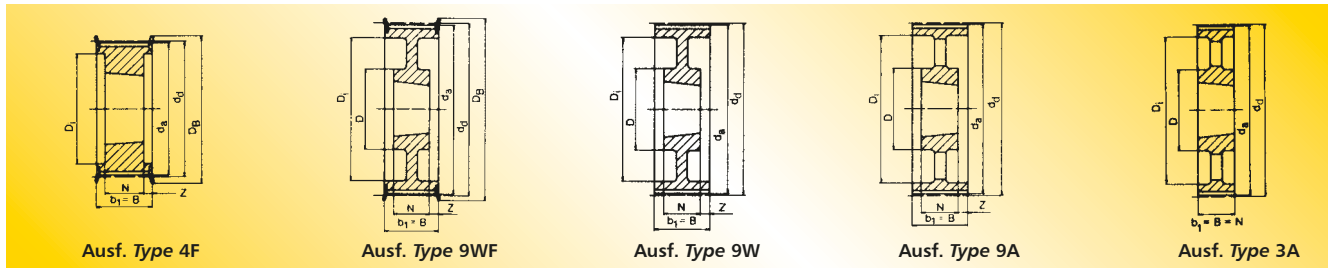

Type 14M – Teilung Pitch 14 mm für Riemenbreite for belt width 85 mm

Bezeichnung Part No.	Anzahl der Zähne No. of teeth	Aus- führung Type	Material	d _d (mm)	d _a (mm)	D _B (mm)	b ₁ (mm)	B (mm)	N (mm)	V (mm)	Z (mm)	D (mm)	D _i (mm)	Taper- Buchse Taper bush	Gewicht ohne Buchse Weight without bush (≈ kg)	€ Stück ohne Buchse each without bush
TB 28-14M-85	28	4F	GG	124,78	122,12	127	102	102	45	—	28,5	—	98	2517	2,70	auf Anfrage on request
TB 29-14M-85	29	4F	GG	129,23	126,57	138	102	102	45	—	28,5	—	100	2517	3,40	
TB 30-14M-85	30	4F	GG	133,69	130,99	138	102	102	45	—	28,5	—	100	2517	3,75	
TB 32-14M-85	32	4F	GG	142,60	139,88	154	102	102	45	—	28,5	—	108	2517	4,80	
TB 34-14M-85	34	4F	GG	151,52	148,79	160	102	102	45	—	28,5	—	110	2517	6,00	
TB 36-14M-85	36	4F	GG	160,43	157,68	168	102	102	51	—	25,5	—	120	3020	5,80	
TB 38-14M-85	38	4F	GG	169,34	166,60	183	102	102	51	—	25,5	—	130	3020	6,80	
TB 40-14M-85	40	4F	GG	178,25	175,49	188	102	102	51	—	25,5	—	138	3020	8,00	
TB 44-14M-85	44	4F	GG	196,08	193,28	211	102	102	76	—	13,0	—	155	3030	11,80	
TB 48-14M-85	48	4F	GG	213,90	211,11	226	102	102	76	—	13,0	—	170	3030	15,10	
TB 56-14M-85	56	4F	GG	249,55	246,76	256	102	102	65	—	18,5	190	210	3525	19,00	
TB 64-14M-85	64	9WF	GG	285,21	282,41	296	102	102	65	—	18,5	190	242	3525	23,00	
TB 72-14M-85	72	9W	GG	320,86	318,06	—	102	102	65	—	18,5	190	280	3525	25,00	
TB 80-14M-85	80	9A	GG	356,51	353,71	—	102	102	65	—	18,5	190	315	3525	26,00	
TB 90-14M-85	90	9A	GG	401,07	398,28	—	102	102	65	—	18,5	190	360	3525	27,80	
TB 112-14M-85	112	9A	GG	499,11	496,32	—	102	102	65	—	18,5	190	457	3525	36,50	
TB 144-14M-85	144	9A	GG	641,71	638,92	—	102	102	65	—	18,5	190	600	3525	48,00	
TB 168-14M-85	168	9A	GG	748,66	745,87	—	102	102	65	—	18,5	190	706	3525	60,00	
TB 192-14M-85	192	3A	GG	855,62	852,82	—	102	102	102	—	—	230	813	4040	86,00	
TB 216-14M-85	216	3A	GG	962,57	959,77	—	102	102	102	—	—	230	920	4040	91,50	

Type 14M – Teilung Pitch 14 mm für Riemenbreite for belt width 115 mm

TB 28-14M-115	28	4F	GG	124,78	122,12	127	133	133	45	—	44,0	—	98	2517	3,77	auf Anfrage on request
TB 29-14M-115	29	4F	GG	129,23	126,57	138	133	133	45	—	44,0	—	100	2517	4,00	
TB 30-14M-115	30	4F	GG	133,69	130,99	138	133	133	45	—	44,0	—	100	2517	5,00	
TB 32-14M-115	32	4F	GG	142,60	139,88	154	133	133	45	—	44,0	—	108	2517	6,80	
TB 34-14M-115	34	4F	GG	151,52	148,79	160	133	133	45	—	44,0	—	110	2517	6,80	
TB 36-14M-115	36	4F	GG	160,43	157,68	168	133	133	51	—	41,0	—	120	3020	7,00	
TB 38-14M-115	38	4F	GG	169,34	166,60	183	133	133	51	—	41,0	—	130	3020	8,40	
TB 40-14M-115	40	4F	GG	178,25	175,49	188	133	133	51	—	41,0	—	140	3020	9,20	
TB 44-14M-115	44	4F	GG	196,08	193,28	211	133	133	76	—	28,5	—	155	3030	14,00	
TB 48-14M-115	48	4F	GG	213,90	211,11	226	133	133	76	—	28,5	—	170	3030	17,10	
TB 56-14M-115	56	4F	GG	249,55	246,76	256	133	133	89	—	22,0	—	210	3535	24,80	
TB 64-14M-115	64	9WF	GG	285,21	282,41	296	133	133	89	—	22,0	190	242	3535	27,00	
TB 72-14M-115	72	9W	GG	320,86	318,06	—	133	133	89	—	22,0	190	280	3535	29,00	
TB 80-14M-115	80	9A	GG	356,51	353,71	—	133	133	89	—	22,0	190	315	3535	32,00	
TB 90-14M-115	90	9A	GG	401,07	398,28	—	133	133	89	—	22,0	190	360	3535	36,50	
TB 112-14M-115	112	9A	GG	499,11	496,32	—	133	133	89	—	22,0	190	457	3535	46,00	
TB 144-14M-115	144	9A	GG	641,71	638,92	—	133	133	102	—	15,5	230	600	4040	68,00	
TB 168-14M-115	168	9A	GG	748,66	745,87	—	133	133	102	—	15,5	230	706	4040	82,60	
TB 192-14M-115	192	9A	GG	855,62	852,82	—	133	133	102	—	15,5	230	813	4040	96,00	
TB 216-14M-115	216	9A	GG	962,57	959,77	—	133	133	102	—	15,5	230	920	4040	107,00	

Taperbuchse Taper bush	2517	3020	3030	3525	3535	4040
Bohrung d ₂ (mm) von ... bis ... Bore d ₂ (mm) from ... to ...	16-60	25-75	35-75	35-90	35-90	40-100
€/Stück each	auf Anfrage / on request					

GG = Grauguss Cast iron
Fertigungstechnische Änderungen vorbehalten.
We reserve the right to make technical changes.

Bohrungsdurchmesser d₂ siehe Seite 3-4.
Bore diameters d₂ see page 3-4.

HTD®-Zahnscheiben für Taperbuchsen HTD® pulleys for taper bushes

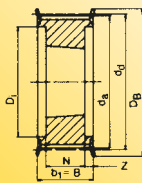

Ausf. Type 4F

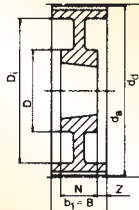

Ausf. Type 9W

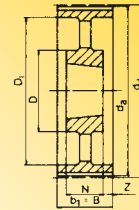

Ausf. Type 9A

Type 14M – Teilung Pitch 14 mm für Riemenbreite for belt width 170 mm

Bezeichnung Part No.	Anzahl der Zähne No. of teeth	Aus- führung Type	Material	d _d (mm)	d _s (mm)	D _B (mm)	b ₁ (mm)	B (mm)	N (mm)	V (mm)	Z (mm)	D (mm)	D _i (mm)	Taper- Buchse Taper bush	Gewicht ohne Buchse Weight without bush (≈ kg)	€ Stück ohne Buchse each without bush
TB 38-14M-170	38	4F	GG	169,34	166,60	183	187	187	76	—	55,5	—	130	3030	11,70	auf Anfrage on request
TB 40-14M-170	40	4F	GG	178,25	175,49	188	187	187	76	—	55,5	—	140	3030	13,00	
TB 44-14M-170	44	4F	GG	196,08	193,28	211	187	187	89	—	49,0	—	155	3535	15,00	
TB 48-14M-170	48	4F	GG	213,90	211,11	226	187	187	89	—	49,0	—	175	3535	19,00	
TB 56-14M-170	56	4F	GG	249,55	246,76	256	187	187	89	—	49,0	—	210	3535	28,50	
TB 64-14M-170	64	4F	GG	285,21	282,41	296	187	187	102	—	42,5	—	240	4040	41,00	
TB 72-14M-170	72	9W	GG	320,86	318,06	—	187	187	102	—	42,5	230	280	4040	46,90	
TB 80-14M-170	80	9W	GG	356,51	353,71	—	187	187	102	—	42,5	230	315	4040	48,00	
TB 90-14M-170	90	9A	GG	401,07	398,28	—	187	187	102	—	42,5	230	360	4040	52,50	
TB 112-14M-170	112	9A	GG	499,11	496,32	—	187	187	127	—	30,0	265	457	5050	74,50	
TB 144-14M-170	144	9A	GG	641,71	638,92	—	187	187	127	—	30,0	265	600	5050	91,00	
TB 168-14M-170	168	9A	GG	748,66	745,87	—	187	187	127	—	30,0	265	706	5050	116,00	
TB 192-14M-170	192	9A	GG	855,62	852,82	—	187	187	127	—	30,0	265	813	5050	134,00	
TB 216-14M-170	216	9A	GG	962,57	959,77	—	187	187	127	—	30,0	265	920	5050	146,50	

HTD®-Zahnscheiben Type 20M auf Anfrage HTD® pulleys type 20M on request

Taperbuchse Taper bush	3030	3535	4040	5050
Bohrung d ₂ (mm) von ... bis ... Bore d ₂ (mm) from ... to ...	35-75	35-90	40-100	70-125
€/Stück each	auf Anfrage / on request			

GG = Grauguss Cast iron
Fertigungstechnische Änderungen vorbehalten.
We reserve the right to make technical changes.

Bohrungsdurchmesser d₂ siehe Seite 3-4.
Bore diameters d₂ see page 3-4.

Metrische Zahnscheiben für zylindrische Bohrung

Metric timing belt pulleys for plain boring

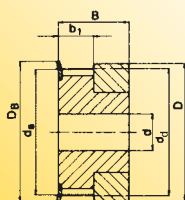

Ausf. Type 1F

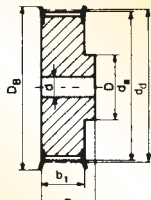

Ausf. Type 6F

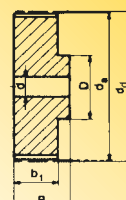

Ausf. Type 6

Type T2,5 – Teilung Pitch 2,5 mm für Riemenbreite for belt width 4 und and 6 mm

Bezeichnung Part No.	Anzahl der Zähne No. of teeth	Aus- führung Type	Material	d_d (mm)	d_s (mm)	D_B (mm)	b_1 (mm)	B (mm)	D (mm)	D_i (mm)	Vor- bohrung Pilot bore d (mm)	Fertig- bohrung Finished bore d_{max} (mm)	Gewicht Weight (≈ kg)	€ Stück each
16 T2,5/12-2	12	1F	Al	9,55	9,00	13,0	9	16	12	—	—	3	0,003	auf Anfrage on request
16 T2,5/14-2	14	1F	Al	11,14	10,60	15,0	9	16	14	—	—	4	0,004	
16 T2,5/15-2	15	1F	Al	11,94	11,40	15,0	9	16	15	—	—	4	0,005	
16 T2,5/16-2	16	1F	Al	12,73	12,20	16,0	9	16	16	—	—	5	0,005	
16 T2,5/18-2	18	6F	Al	14,32	13,80	17,5	10	16	9,5	—	4	6	0,006	
16 T2,5/19-2	19	6F	Al	15,12	14,60	18,0	10	16	9,5	—	4	6	0,007	
16 T2,5/20-2	20	6F	Al	15,92	15,40	19,5	10	16	10	—	4	6	0,008	
16 T2,5/22-2	22	6F	Al	17,51	17,00	23,0	10	16	10	—	4	6	0,009	
16 T2,5/24-2	24	6F	Al	19,10	18,55	23,0	10	16	12	—	4	6	0,012	
16 T2,5/25-2	25	6F	Al	19,90	19,35	23,0	10	16	12	—	4	8	0,013	
16 T2,5/26-2	26	6F	Al	20,70	20,15	25,0	10	16	13	—	4	8	0,014	
16 T2,5/28-2	28	6F	Al	22,28	21,75	25,0	10	16	13	—	4	8	0,016	
16 T2,5/30-2	30	6F	Al	23,87	23,35	28,0	10	16	16	—	6	10	0,018	
16 T2,5/32-2	32	6F	Al	25,47	24,95	32,0	10	16	16	—	6	10	0,020	
16 T2,5/36-2	36	6F	Al	28,65	28,10	36,0	10	16	20	—	6	12	0,026	
16 T2,5/40-2	40	6F	Al	31,83	31,30	38,0	10	16	20	—	6	12	0,032	
16 T2,5/44-2	44	6F	Al	35,02	34,50	42,0	10	16	24	—	6	14	0,040	
16 T2,5/48-0	48	6	Al	38,20	37,70	—	10	16	26	—	6	15	0,048	
16 T2,5/60-0	60	6	Al	47,75	47,25	—	10	16	34	—	8	18	0,073	



Al = Aluminium

Fertigungstechnische Änderungen vorbehalten. We reserve the right to make technical changes.

Metrische Zahnscheiben für zylindrische Bohrung Metric timing belt pulleys for plain boring

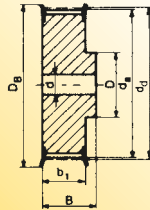

Ausf. Type 6F

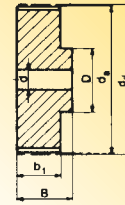

Ausf. Type 6

Type T5 – Teilung *Pitch* 5 mm für Riemenbreite *for belt width* 10 mm

Bezeichnung Part No.	Anzahl der Zähne No. of teeth	Aus- führung Type	Material	d _d (mm)	d _s (mm)	D _B (mm)	b ₁ (mm)	B (mm)	D (mm)	D _i (mm)	Vor- bohrung Pilot bore d (mm)	Fertig- bohrung Finished bore d _{max} (mm)	Gewicht Weight (≈ kg)	€ Stück each
21 T5/10-2	10	6F	Al	15,92	15,05	19,5	15	21	8	—	—	5	0,012	auf Anfrage on request
21 T5/12-2	12	6F	Al	19,01	18,25	23,0	15	21	10	—	—	6	0,016	
21 T5/14-2	14	6F	Al	22,29	21,45	25,0	15	21	13	—	—	8	0,019	
21 T5/15-2	15	6F	Al	23,88	23,05	28,0	15	21	16	—	6	10	0,021	
21 T5/16-2	16	6F	Al	25,47	24,60	32,0	15	21	18	—	6	11	0,025	
21 T5/18-2	18	6F	Al	28,65	27,80	32,0	15	21	19	—	6	12	0,031	
21 T5/19-2	19	6F	Al	30,25	29,40	36,0	15	21	22	—	6	12	0,036	
21 T5/20-2	20	6F	Al	31,83	31,00	36,0	15	21	23	—	6	14	0,038	
21 T5/22-2	22	6F	Al	35,12	34,25	38,0	15	21	24	—	6	15	0,046	
21 T5/24-2	24	6F	Al	38,21	37,40	42,0	15	21	26	—	6	15	0,054	
21 T5/25-2	25	6F	Al	39,80	39,00	44,0	15	21	26	—	6	15	0,058	
21 T5/26-2	26	6F	Al	41,47	40,60	44,0	15	21	26	—	6	16	0,062	
21 T5/27-2	27	6F	Al	42,98	42,20	48,0	15	21	30	—	8	18	0,064	
21 T5/28-2	28	6F	Al	44,62	43,75	48,0	15	21	32	—	8	18	0,071	
21 T5/30-2	30	6F	Al	47,76	46,95	51,0	15	21	34	—	8	18	0,075	
21 T5/32-2	32	6F	Al	50,94	50,10	54,0	15	21	38	—	8	22	0,088	
21 T5/36-2	36	6F	Al	57,31	56,45	63,0	15	21	38	—	8	22	0,114	
21 T5/40-2	40	6F	Al	63,66	62,85	66,0	15	21	40	—	8	23	0,138	
21 T5/42-2	42	6F	Al	66,87	66,00	71,0	15	21	40	—	8	24	0,180	
21 T5/44-0	44	6	Al	70,07	69,20	—	15	21	45	—	8	26	0,185	
21 T5/48-0	48	6	Al	76,42	75,55	—	15	21	50	—	8	28	0,200	
21 T5/60-0	60	6	Al	95,52	94,65	—	15	21	65	—	8	35	0,307	

Type T5 – Teilung *Pitch* 5 mm für Riemenbreite *for belt width* 16 mm

27 T5/10-2	10	6F	Al	15,92	15,05	19,5	21	27	8	—	—	5	0,016	auf Anfrage on request
27 T5/12-2	12	6F	Al	19,01	18,25	23,0	21	27	10	—	—	6	0,022	
27 T5/14-2	14	6F	Al	22,29	21,45	25,0	21	27	13	—	—	8	0,026	
27 T5/15-2	15	6F	Al	23,88	23,05	28,0	21	27	16	—	6	10	0,029	
27 T5/16-2	16	6F	Al	25,47	24,60	32,0	21	27	18	—	6	11	0,035	
27 T5/18-2	18	6F	Al	28,65	27,80	32,0	21	27	19	—	6	12	0,043	
27 T5/19-2	19	6F	Al	30,25	29,40	36,0	21	27	22	—	6	12	0,049	
27 T5/20-2	20	6F	Al	31,83	31,00	36,0	21	27	23	—	6	14	0,053	
27 T5/22-2	22	6F	Al	35,12	34,25	38,0	21	27	24	—	6	15	0,054	
27 T5/24-2	24	6F	Al	38,21	37,40	42,0	21	27	26	—	6	15	0,076	
27 T5/25-2	25	6F	Al	39,80	39,00	44,0	21	27	26	—	6	15	0,081	
27 T5/26-2	26	6F	Al	41,47	40,60	44,0	21	27	26	—	6	16	0,085	
27 T5/27-2	27	6F	Al	42,98	42,20	48,0	21	27	30	—	8	18	0,090	
27 T5/28-2	28	6F	Al	44,62	43,75	48,0	21	27	32	—	8	18	0,092	
27 T5/30-2	30	6F	Al	47,76	46,95	51,0	21	27	34	—	8	18	0,105	
27 T5/32-2	32	6F	Al	50,94	50,10	54,0	21	27	38	—	8	22	0,123	
27 T5/36-2	36	6F	Al	57,31	56,45	63,0	21	27	38	—	8	22	0,160	
27 T5/40-2	40	6F	Al	63,66	62,85	66,0	21	27	40	—	8	23	0,193	
27 T5/42-2	42	6F	Al	66,87	66,00	71,0	21	27	40	—	8	24	0,205	
27 T5/44-0	44	6	Al	70,07	69,20	—	21	27	45	—	8	26	0,228	
27 T5/48-0	48	6	Al	76,42	75,55	—	21	27	50	—	8	28	0,280	
27 T5/60-0	60	6	Al	95,52	94,65	—	21	27	65	—	8	35	0,430	

Metrische Zahnscheiben für zylindrische Bohrung

Metric timing belt pulleys for plain boring

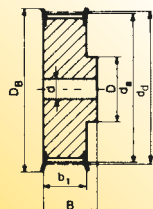

Ausf. Type 6F

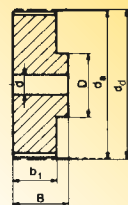

Ausf. Type 6

Type T5 – Teilung Pitch 5 mm für Riemenbreite for belt width 25 mm

Bezeichnung Part No.	Anzahl der Zähne No. of teeth	Aus- führung Type	Material	d _d (mm)	d _s (mm)	D _B (mm)	b ₁ (mm)	B (mm)	D (mm)	D _i (mm)	Vor- bohrung Pilot bore d (mm)	Fertig- bohrung Finished bore d _{max} (mm)	Gewicht Weight (≈ kg)	€ Stück each
36 T5/10-2	10	6F	Al	15,92	15,05	19,5	30	36	8	—	—	5	0,023	auf Anfrage on request
36 T5/12-2	12	6F	Al	19,01	18,25	23,0	30	36	10	—	—	6	0,031	
36 T5/14-2	14	6F	Al	22,29	21,45	25,0	30	36	13	—	—	8	0,037	
36 T5/15-2	15	6F	Al	23,88	23,05	28,0	30	36	16	—	6	10	0,041	
36 T5/16-2	16	6F	Al	25,47	24,60	32,0	30	36	18	—	6	11	0,050	
36 T5/18-2	18	6F	Al	28,65	27,80	32,0	30	36	19	—	6	12	0,061	
36 T5/19-2	19	6F	Al	30,25	29,40	36,0	30	36	22	—	6	12	0,070	
36 T5/20-2	20	6F	Al	31,83	31,00	36,0	30	36	23	—	6	14	0,076	
36 T5/22-2	22	6F	Al	35,12	34,25	38,0	30	36	24	—	6	15	0,080	
36 T5/24-2	24	6F	Al	38,21	37,40	42,0	30	36	26	—	8	15	0,109	
36 T5/25-2	25	6F	Al	39,80	39,00	44,0	30	36	26	—	8	15	0,116	
36 T5/26-2	26	6F	Al	41,47	40,60	44,0	30	36	26	—	8	16	0,120	
36 T5/27-2	27	6F	Al	42,98	42,20	48,0	30	36	30	—	8	18	0,128	
36 T5/28-2	28	6F	Al	44,62	43,75	48,0	30	36	32	—	8	18	0,135	
36 T5/30-2	30	6F	Al	47,76	46,95	51,0	30	36	34	—	8	18	0,150	
36 T5/32-2	32	6F	Al	50,94	50,10	54,0	30	36	38	—	8	22	0,176	
36 T5/36-2	36	6F	Al	57,31	56,45	63,0	30	36	38	—	8	22	0,230	
36 T5/40-2	40	6F	Al	63,66	62,85	66,0	30	36	40	—	8	23	0,276	
36 T5/42-2	42	6F	Al	66,87	66,00	71,0	30	36	40	—	8	24	0,284	
36 T5/44-0	44	6	Al	70,07	69,20	—	30	36	45	—	8	26	0,315	
36 T5/48-0	48	6	Al	76,42	75,55	—	30	36	50	—	8	28	0,400	
36 T5/60-0	60	6	Al	95,52	94,65	—	30	36	65	—	8	35	0,614	

Al = Aluminium

Fertigungstechnische Änderungen vorbehalten. We reserve the right to make technical changes.

Metrische Zahnscheiben für zylindrische Bohrung Metric timing belt pulleys for plain boring

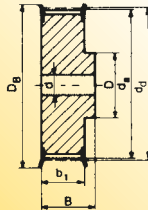

Ausf. Type 6F

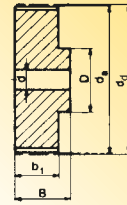

Ausf. Type 6

Type T10 – Teilung *Pitch* 10 mm für Riemenbreite *for belt width* 16 mm

Bezeichnung Part No.	Anzahl der Zähne No. of teeth	Aus- führung Type	Material	d _d (mm)	d _s (mm)	D _B (mm)	b ₁ (mm)	B (mm)	D (mm)	D ₁ (mm)	Vor- bohrung Pilot bore d (mm)	Fertig- bohrung Finished bore d _{max} (mm)	Gewicht Weight (≈ kg)	€ Stück each
31 T10/12-2	12	6F	Al	38,20	36,35	42	21	31	28	—	6	16	0,076	auf Anfrage on request
31 T10/14-2	14	6F	Al	44,56	42,70	48	21	31	32	—	8	18	0,104	
31 T10/15-2	15	6F	Al	47,75	45,90	51	21	31	32	—	8	18	0,116	
31 T10/16-2	16	6F	Al	50,93	49,05	54	21	31	35	—	8	20	0,134	
31 T10/18-2	18	6F	Al	57,29	55,45	60	21	31	40	—	8	22	0,167	
31 T10/19-2	19	6F	Al	60,48	58,60	66	21	31	44	—	8	22	0,184	
31 T10/20-2	20	6F	Al	63,66	61,80	66	21	31	46	—	8	24	0,208	
31 T10/22-2	22	6F	Al	70,03	68,15	75	21	31	52	—	8	28	0,253	
31 T10/24-2	24	6F	Al	76,39	74,55	83	21	31	58	—	8	30	0,288	
31 T10/25-2	25	6F	Al	79,58	77,70	83	21	31	60	—	8	30	0,310	
31 T10/26-2	26	6F	Al	82,76	80,90	87	21	31	60	—	8	30	0,357	
31 T10/27-2	27	6F	Al	85,95	84,10	91	21	31	60	—	8	30	0,364	
31 T10/28-2	28	6F	Al	89,13	87,25	93	21	31	60	—	8	30	0,401	
31 T10/30-2	30	6F	Al	95,49	93,65	97	21	31	60	—	8	30	0,441	
31 T10/32-2	32	6F	Al	101,86	100,00	106	21	31	65	—	10	32	0,493	
31 T10/36-2	36	6F	Al	114,59	112,75	119	21	31	70	—	10	35	0,623	
31 T10/40-2	40	6F	Al	127,32	125,45	131	21	31	80	—	10	40	0,767	
31 T10/44-0	44	6	Al	140,06	138,20	—	21	31	88	—	10	46	0,993	
31 T10/48-0	48	6	Al	152,78	150,95	—	21	31	95	—	16	48	1,090	
31 T10/60-0	60	6	Al	190,98	189,10	—	21	31	110	—	16	60	1,710	

Type T10 – Teilung *Pitch* 10 mm für Riemenbreite *for belt width* 25 mm

40 T10/12-2	12	6F	Al	38,20	36,35	42	30	40	28	—	6	16	0,099	auf Anfrage on request
40 T10/14-2	14	6F	Al	44,56	42,70	48	30	40	32	—	8	18	0,134	
40 T10/15-2	15	6F	Al	47,75	45,90	51	30	40	32	—	8	18	0,152	
40 T10/16-2	16	6F	Al	50,93	49,05	54	30	40	35	—	8	20	0,176	
40 T10/18-2	18	6F	Al	57,29	55,45	60	30	40	40	—	8	22	0,224	
40 T10/19-2	19	6F	Al	60,48	58,60	66	30	40	44	—	8	22	0,247	
40 T10/20-2	20	6F	Al	63,66	61,80	66	30	40	46	—	8	24	0,276	
40 T10/22-2	22	6F	Al	70,03	68,15	75	30	40	52	—	8	28	0,337	
40 T10/24-2	24	6F	Al	76,39	74,55	83	30	40	58	—	8	30	0,392	
40 T10/25-2	25	6F	Al	79,58	77,70	83	30	40	60	—	8	30	0,422	
40 T10/26-2	26	6F	Al	82,76	80,90	87	30	40	60	—	8	30	0,477	
40 T10/27-2	27	6F	Al	85,95	84,10	91	30	40	60	—	8	30	0,536	
40 T10/28-2	28	6F	Al	89,13	87,25	93	30	40	60	—	8	30	0,540	
40 T10/30-2	30	6F	Al	95,49	93,65	97	30	40	60	—	8	30	0,640	
40 T10/32-2	32	6F	Al	101,86	100,00	106	30	40	65	—	10	32	0,693	
40 T10/36-2	36	6F	Al	114,59	112,75	119	30	40	70	—	10	35	0,873	
40 T10/40-2	40	6F	Al	127,32	125,45	131	30	40	80	—	10	40	1,067	
40 T10/44-0	44	6	Al	140,06	138,20	—	30	40	88	—	10	46	1,350	
40 T10/48-0	48	6	Al	152,78	150,95	—	30	40	95	—	16	48	1,516	
40 T10/60-0	60	6	Al	190,98	189,10	—	30	40	110	—	16	60	2,339	

Metrische Zahnscheiben für zylindrische Bohrung Metric timing belt pulleys for plain boring

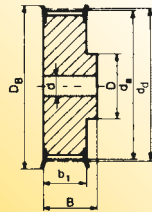

Ausf. Type 6F

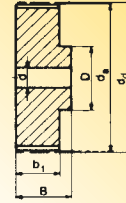

Ausf. Type 6

Type T10 – Teilung Pitch 10 mm für Riemenbreite for belt width 32 mm

Bezeichnung Part No.	Anzahl der Zähne No. of teeth	Aus- führung Type	Material	d _d (mm)	d _s (mm)	D _B (mm)	b ₁ (mm)	B (mm)	D (mm)	D _i (mm)	Vor- bohrung Pilot bore d (mm)	Fertig- bohrung Finished bore d _{max} (mm)	Gewicht Weight (≈ kg)	€ Stück each
47 T10/18-2	18	6F	Al	57,29	55,45	60	37	47	40	—	10	22	0,253	auf Anfrage on request
47 T10/19-2	19	6F	Al	60,48	58,60	66	37	47	44	—	10	22	0,286	
47 T10/20-2	20	6F	Al	63,66	61,80	66	37	47	46	—	12	24	0,322	
47 T10/22-2	22	6F	Al	70,03	68,15	75	37	47	52	—	12	28	0,393	
47 T10/24-2	24	6F	Al	76,39	74,55	83	37	47	58	—	12	30	0,475	
47 T10/25-2	25	6F	Al	79,58	77,70	83	37	47	60	—	12	30	0,527	
47 T10/26-2	26	6F	Al	82,76	80,90	87	37	47	60	—	12	30	0,564	
47 T10/27-2	27	6F	Al	85,95	84,10	91	37	47	60	—	12	30	0,602	
47 T10/28-2	28	6F	Al	89,13	87,25	93	37	47	60	—	12	30	0,642	
47 T10/30-2	30	6F	Al	95,49	93,65	97	37	47	60	—	12	30	0,740	
47 T10/32-2	32	6F	Al	101,86	100,00	106	37	47	65	—	12	32	0,844	
47 T10/36-2	36	6F	Al	114,59	112,75	119	37	47	70	—	16	35	1,083	
47 T10/40-2	40	6F	Al	127,32	125,45	131	37	47	80	—	16	40	1,317	
47 T10/44-0	44	6	Al	140,06	138,20	—	37	47	88	—	16	46	1,611	
47 T10/48-0	48	6	Al	152,78	150,95	—	37	47	95	—	16	48	1,931	
47 T10/60-0	60	6	Al	190,98	189,10	—	37	47	110	—	16	60	3,004	

Type T10 – Teilung Pitch 10 mm für Riemenbreite for belt width 50 mm

66 T10/18-2	18	6F	Al	57,29	55,45	60	56	66	40	—	10	22	0,422	auf Anfrage on request
66 T10/19-2	19	6F	Al	60,48	58,60	66	56	66	44	—	10	22	0,466	
66 T10/20-2	20	6F	Al	63,66	61,80	66	56	66	46	—	12	24	0,520	
66 T10/22-2	22	6F	Al	70,03	68,15	75	56	66	52	—	12	28	0,570	
66 T10/24-2	24	6F	Al	76,39	74,55	83	56	66	58	—	12	30	0,736	
66 T10/25-2	25	6F	Al	79,58	77,70	83	56	66	60	—	12	30	0,766	
66 T10/26-2	26	6F	Al	82,76	80,90	87	56	66	60	—	12	30	0,816	
66 T10/27-2	27	6F	Al	85,95	84,10	91	56	66	60	—	12	30	0,946	
66 T10/28-2	28	6F	Al	89,13	87,25	93	56	66	60	—	12	30	0,960	
66 T10/30-2	30	6F	Al	95,49	93,65	97	56	66	60	—	12	30	1,169	
66 T10/32-2	32	6F	Al	101,86	100,00	106	56	66	65	—	12	32	1,300	
66 T10/36-2	36	6F	Al	114,59	112,75	119	56	66	70	—	16	35	1,637	
66 T10/40-2	40	6F	Al	127,32	125,45	131	56	66	80	—	16	40	1,999	
66 T10/44-0	44	6	Al	140,06	138,20	—	56	66	88	—	16	46	2,357	
66 T10/48-0	48	6	Al	152,78	150,95	—	56	66	95	—	16	48	2,830	
66 T10/60-0	60	6	Al	190,98	189,10	—	56	66	110	—	16	60	4,366	

Al = Aluminium

Fertigungstechnische Änderungen vorbehalten. We reserve the right to make technical changes.

Metrische Zahnscheiben für zylindrische Bohrung Metric timing belt pulleys for plain boring

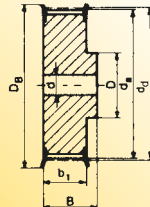

Ausf. Type 6F

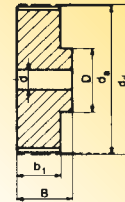

Ausf. Type 6

Type AT5 – Teilung Pitch 5 mm für Riemenbreite for belt width 10 mm

Bezeichnung Part No.	Anzahl der Zähne No. of teeth	Aus- führung Type	Material	d _d (mm)	d _a (mm)	D _B (mm)	b ₁ (mm)	B (mm)	D (mm)	Vor- bohrung Pilot bore d (mm)	Fertig- bohrung Finished bore d _{max} (mm)	Gewicht Weight (≈ kg)	€ Stück each
21 AT5/12-2	12	6F	Al	19,01	17,85	23,0	15	21	10	—	6	0,016	auf Anfrage on request
21 AT5/14-2	14	6F	Al	22,29	21,05	25,0	15	21	13	—	8	0,019	
21 AT5/15-2	15	6F	Al	23,88	22,65	28,0	15	21	16	6	10	0,021	
21 AT5/16-2	16	6F	Al	25,47	24,20	32,0	15	21	18	6	11	0,025	
21 AT5/18-2	18	6F	Al	28,65	27,40	32,0	15	21	19	6	12	0,031	
21 AT5/19-2	19	6F	Al	30,25	29,00	36,0	15	21	22	6	12	0,036	
21 AT5/20-2	20	6F	Al	31,83	30,60	36,0	15	21	23	6	14	0,038	
21 AT5/22-2	22	6F	Al	35,12	33,85	38,0	15	21	24	6	15	0,046	
21 AT5/24-2	24	6F	Al	38,21	37,00	42,0	15	21	26	6	15	0,054	
21 AT5/25-2	25	6F	Al	39,80	38,60	44,0	15	21	26	6	15	0,058	
21 AT5/26-2	26	6F	Al	41,47	40,20	44,0	15	21	26	6	16	0,062	
21 AT5/27-2	27	6F	Al	42,98	41,80	48,0	15	21	30	8	18	0,064	
21 AT5/28-2	28	6F	Al	44,62	43,35	48,0	15	21	32	8	18	0,071	
21 AT5/30-2	30	6F	Al	47,76	46,55	51,0	15	21	34	8	18	0,075	
21 AT5/32-2	32	6F	Al	50,94	49,70	54,0	15	21	38	8	22	0,088	
21 AT5/36-2	36	6F	Al	57,31	56,05	63,0	15	21	38	8	22	0,114	
21 AT5/40-2	40	6F	Al	63,66	62,45	66,0	15	21	40	8	23	0,138	
21 AT5/42-2	42	6F	Al	66,87	65,60	71,0	15	21	40	8	24	0,180	
21 AT5/44-0	44	6	Al	70,07	68,80	—	15	21	45	8	26	0,185	
21 AT5/48-0	48	6	Al	76,42	75,15	—	15	21	50	8	28	0,200	
21 AT5/60-0	60	6	Al	95,52	94,25	—	15	21	65	8	35	0,307	

Type AT5 – Teilung Pitch 5 mm für Riemenbreite for belt width 16 mm

27 AT5/12-2	12	6F	Al	19,01	17,85	23,0	21	27	10	—	6	0,022	auf Anfrage on request
27 AT5/14-2	14	6F	Al	22,29	21,05	25,0	21	27	13	—	8	0,026	
27 AT5/15-2	15	6F	Al	23,88	22,65	28,0	21	27	16	6	10	0,029	
27 AT5/16-2	16	6F	Al	25,47	24,20	32,0	21	27	18	6	11	0,035	
27 AT5/18-2	18	6F	Al	28,65	27,40	32,0	21	27	19	6	12	0,043	
27 AT5/19-2	19	6F	Al	30,25	29,00	36,0	21	27	22	6	12	0,049	
27 AT5/20-2	20	6F	Al	31,83	30,60	36,0	21	27	23	6	14	0,053	
27 AT5/22-2	22	6F	Al	35,12	33,85	38,0	21	27	24	6	15	0,054	
27 AT5/24-2	24	6F	Al	38,21	37,00	42,0	21	27	26	6	15	0,076	
27 AT5/25-2	25	6F	Al	39,80	38,60	44,0	21	27	26	6	15	0,081	
27 AT5/26-2	26	6F	Al	41,47	40,20	44,0	21	27	26	6	16	0,085	
27 AT5/27-2	27	6F	Al	42,98	41,80	48,0	21	27	30	8	18	0,090	
27 AT5/28-2	28	6F	Al	44,62	43,35	48,0	21	27	32	8	18	0,092	
27 AT5/30-2	30	6F	Al	47,76	46,55	51,0	21	27	34	8	18	0,105	
27 AT5/32-2	32	6F	Al	50,94	49,70	54,0	21	27	38	8	22	0,123	
27 AT5/36-2	36	6F	Al	57,31	56,05	63,0	21	27	38	8	22	0,160	
27 AT5/40-2	40	6F	Al	63,66	62,45	66,0	21	27	40	8	23	0,193	
27 AT5/42-2	42	6F	Al	66,87	65,60	71,0	21	27	40	8	24	0,205	
27 AT5/44-0	44	6	Al	70,07	68,80	—	21	27	45	8	26	0,228	
27 AT5/48-0	48	6	Al	76,42	75,15	—	21	27	50	8	28	0,280	
27 AT5/60-0	60	6	Al	95,52	94,25	—	21	27	65	8	35	0,430	

Al = Aluminium

Fertigungstechnische Änderungen vorbehalten. We reserve the right to make technical changes.

Metrische Zahnscheiben für zylindrische Bohrung

Metric timing belt pulleys for plain boring

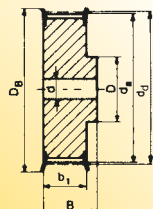

Ausf. Type 6F

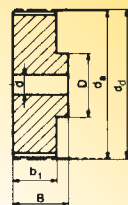

Ausf. Type 6

Type AT5 – Teilung *Pitch* 5 mm für Riemenbreite *for belt width* 25 mm

Bezeichnung Part No.	Anzahl der Zähne No. of teeth	Aus- führung Type	Material	d_d (mm)	d_s (mm)	D_B (mm)	b_1 (mm)	B (mm)	D (mm)	Vor- bohrung Pilot bore d (mm)	Fertig- bohrung Finished bore d_{max} (mm)	Gewicht Weight (≈ kg)	€ Stück each
36 AT5/12-2	12	6F	Al	19,01	17,85	23,0	30	36	10	—	6	0,031	auf Anfrage on request
36 AT5/14-2	14	6F	Al	22,29	21,05	25,0	30	36	13	—	8	0,037	
36 AT5/15-2	15	6F	Al	23,88	22,65	28,0	30	36	16	6	10	0,041	
36 AT5/16-2	16	6F	Al	25,47	24,20	32,0	30	36	18	6	11	0,050	
36 AT5/18-2	18	6F	Al	28,65	27,40	32,0	30	36	19	6	12	0,061	
36 AT5/19-2	19	6F	Al	30,25	29,00	36,0	30	36	22	6	12	0,070	
36 AT5/20-2	20	6F	Al	31,83	30,60	36,0	30	36	23	6	14	0,076	
36 AT5/22-2	22	6F	Al	35,12	33,85	38,0	30	36	24	6	15	0,080	
36 AT5/24-2	24	6F	Al	38,21	37,00	42,0	30	36	26	8	15	0,109	
36 AT5/25-2	25	6F	Al	39,80	38,60	44,0	30	36	26	8	15	0,116	
36 AT5/26-2	26	6F	Al	41,47	40,20	44,0	30	36	26	8	16	0,120	
36 AT5/27-2	27	6F	Al	42,98	41,80	48,0	30	36	30	8	18	0,128	
36 AT5/28-2	28	6F	Al	44,62	43,35	48,0	30	36	32	8	18	0,135	
36 AT5/30-2	30	6F	Al	47,76	46,55	51,0	30	36	34	8	18	0,150	
36 AT5/32-2	32	6F	Al	50,94	49,70	54,0	30	36	38	8	22	0,176	
36 AT5/36-2	36	6F	Al	57,31	56,05	63,0	30	36	38	8	22	0,230	
36 AT5/40-2	40	6F	Al	63,66	62,45	66,0	30	36	40	8	23	0,276	
36 AT5/42-2	42	6F	Al	66,87	65,60	71,0	30	36	40	8	24	0,284	
36 AT5/44-0	44	6	Al	70,07	68,80	—	30	36	45	8	26	0,315	
36 AT5/48-0	48	6	Al	76,42	75,15	—	30	36	50	8	28	0,400	
36 AT5/60-0	60	6	Al	95,52	94,25	—	30	36	65	8	35	0,614	



Al = Aluminium

Fertigungstechnische Änderungen vorbehalten. *We reserve the right to make technical changes.*

Metrische Zahnscheiben für zylindrische Bohrung Metric timing belt pulleys for plain boring

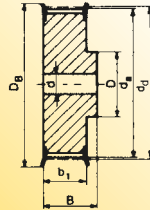

Ausf. Type 6F

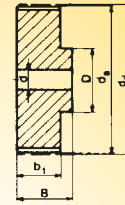

Ausf. Type 6

Type AT10 – Teilung Pitch 10 mm für Riemenbreite for belt width 16 mm

Bezeichnung Part No.	Anzahl der Zähne No. of teeth	Aus- führung Type	Material	d _d (mm)	d _a (mm)	D _B (mm)	b ₁ (mm)	B (mm)	D (mm)	Vor- bohrung Pilot bore d (mm)	Fertig- bohrung Finished bore d _{max} (mm)	Gewicht Weight (≈ kg)	€ Stück each
31 AT10/15-2	15	6F	Al	47,75	45,90	51	21	31	32	8	18	0,116	auf Anfrage on request
31 AT10/16-2	16	6F	Al	50,93	49,05	54	21	31	35	8	20	0,134	
31 AT10/18-2	18	6F	Al	57,29	55,45	60	21	31	40	8	22	0,167	
31 AT10/19-2	19	6F	Al	60,48	58,60	66	21	31	44	8	22	0,184	
31 AT10/20-2	20	6F	Al	63,66	61,80	66	21	31	46	8	24	0,208	
31 AT10/22-2	22	6F	Al	70,03	68,15	75	21	31	52	8	28	0,253	
31 AT10/24-2	24	6F	Al	76,39	74,55	83	21	31	58	8	30	0,288	
31 AT10/25-2	25	6F	Al	79,58	77,70	83	21	31	60	8	30	0,310	
31 AT10/26-2	26	6F	Al	82,76	80,90	87	21	31	60	8	30	0,357	
31 AT10/27-2	27	6F	Al	85,95	84,10	91	21	31	60	8	30	0,364	
31 AT10/28-2	28	6F	Al	89,13	87,25	93	21	31	60	8	30	0,401	
31 AT10/30-2	30	6F	Al	95,49	93,65	97	21	31	60	8	30	0,441	
31 AT10/32-2	32	6F	Al	101,86	100,00	106	21	31	65	10	32	0,493	
31 AT10/36-2	36	6F	Al	114,59	112,75	119	21	31	70	10	35	0,623	
31 AT10/40-2	40	6F	Al	127,32	125,45	131	21	31	80	10	40	0,767	
31 AT10/44-0	44	6	Al	140,06	138,20	—	21	31	88	10	46	0,993	
31 AT10/48-0	48	6	Al	152,78	150,95	—	21	31	95	16	48	1,090	
31 AT10/60-0	60	6	Al	190,98	189,10	—	21	31	110	16	60	1,710	

Type AT10 – Teilung Pitch 10 mm für Riemenbreite for belt width 25 mm

40 AT10/15-2	15	6F	Al	47,75	45,90	51	30	40	32	8	18	0,152	auf Anfrage on request
40 AT10/16-2	16	6F	Al	50,93	49,05	54	30	40	35	8	20	0,176	
40 AT10/18-2	18	6F	Al	57,29	55,45	60	30	40	40	8	22	0,224	
40 AT10/19-2	19	6F	Al	60,48	58,60	66	30	40	44	8	22	0,247	
40 AT10/20-2	20	6F	Al	63,66	61,80	66	30	40	46	8	24	0,276	
40 AT10/22-2	22	6F	Al	70,03	68,15	75	30	40	52	8	28	0,337	
40 AT10/24-2	24	6F	Al	76,39	74,55	83	30	40	58	8	30	0,392	
40 AT10/25-2	25	6F	Al	79,58	77,70	83	30	40	60	8	30	0,422	
40 AT10/26-2	26	6F	Al	82,76	80,90	87	30	40	60	8	30	0,477	
40 AT10/27-2	27	6F	Al	85,95	84,10	91	30	40	60	8	30	0,536	
40 AT10/28-2	28	6F	Al	89,13	87,25	93	30	40	60	8	30	0,540	
40 AT10/30-2	30	6F	Al	95,49	93,65	97	30	40	60	8	30	0,640	
40 AT10/32-2	32	6F	Al	101,86	100,00	106	30	40	65	10	32	0,693	
40 AT10/36-2	36	6F	Al	114,59	112,75	119	30	40	70	10	35	0,873	
40 AT10/40-2	40	6F	Al	127,32	125,45	131	30	40	80	10	40	1,067	
40 AT10/44-0	44	6	Al	140,06	138,20	—	30	40	88	10	46	1,350	
40 AT10/48-0	48	6	Al	152,78	150,95	—	30	40	95	16	48	1,516	
40 AT10/60-0	60	6	Al	190,98	189,10	—	30	40	110	16	60	2,339	

Metrische Zahnscheiben für zylindrische Bohrung Metric timing belt pulleys for plain boring

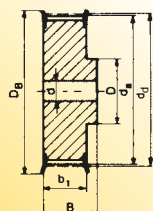

Ausf. Type 6F

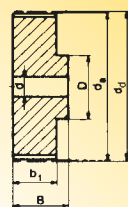

Ausf. Type 6

Type AT10 – Teilung *Pitch* 10 mm für Riemenbreite *for belt width* 32 mm

Bezeichnung Part No.	Anzahl der Zähne No. of teeth	Aus- führung Type	Material	d_d (mm)	d_s (mm)	D_B (mm)	b_1 (mm)	B (mm)	D (mm)	Vor- bohrung Pilot bore d (mm)	Fertig- bohrung Finished bore d_{max} (mm)	Gewicht Weight (≈ kg)	€ Stück each
47 AT10/18-2	18	6F	Al	57,29	55,45	60	37	47	40	10	22	0,253	auf Anfrage on request
47 AT10/19-2	19	6F	Al	60,48	58,60	66	37	47	44	10	22	0,286	
47 AT10/20-2	20	6F	Al	63,66	61,80	66	37	47	46	12	24	0,322	
47 AT10/22-2	22	6F	Al	70,03	68,15	75	37	47	52	12	28	0,393	
47 AT10/24-2	24	6F	Al	76,39	74,55	83	37	47	58	12	30	0,475	
47 AT10/25-2	25	6F	Al	79,58	77,70	83	37	47	60	12	30	0,527	
47 AT10/26-2	26	6F	Al	82,76	80,90	87	37	47	60	12	30	0,564	
47 AT10/27-2	27	6F	Al	85,95	84,10	91	37	47	60	12	30	0,602	
47 AT10/28-2	28	6F	Al	89,13	87,25	93	37	47	60	12	30	0,642	
47 AT10/30-2	30	6F	Al	95,49	93,65	97	37	47	60	12	30	0,740	
47 AT10/32-2	32	6F	Al	101,86	100,00	106	37	47	65	12	32	0,844	
47 AT10/36-2	36	6F	Al	114,59	112,75	119	37	47	70	16	35	1,083	
47 AT10/40-2	40	6F	Al	127,32	125,45	131	37	47	80	16	40	1,317	
47 AT10/44-0	44	6	Al	140,06	138,20	—	37	47	88	16	46	1,611	
47 AT10/48-0	48	6	Al	152,78	150,95	—	37	47	95	16	48	1,931	
47 AT10/60-0	60	6	Al	190,98	189,10	—	37	47	110	16	60	3,004	

Type AT10 – Teilung *Pitch* 10 mm für Riemenbreite *for belt width* 50 mm

66 AT10/18-2	18	6F	Al	57,29	55,45	60	56	66	40	10	22	0,422	auf Anfrage on request
66 AT10/19-2	19	6F	Al	60,48	58,60	66	56	66	44	10	22	0,466	
66 AT10/20-2	20	6F	Al	63,66	61,80	66	56	66	46	12	24	0,520	
66 AT10/22-2	22	6F	Al	70,03	68,15	75	56	66	52	12	28	0,570	
66 AT10/24-2	24	6F	Al	76,39	74,55	83	56	66	58	12	30	0,736	
66 AT10/25-2	25	6F	Al	79,58	77,70	83	56	66	60	12	30	0,766	
66 AT10/26-2	26	6F	Al	82,76	80,90	87	56	66	60	12	30	0,816	
66 AT10/27-2	27	6F	Al	85,95	84,10	91	56	66	60	12	30	0,946	
66 AT10/28-2	28	6F	Al	89,13	87,25	93	56	66	60	12	30	0,960	
66 AT10/30-2	30	6F	Al	95,49	93,65	97	56	66	60	12	30	1,169	
66 AT10/32-2	32	6F	Al	101,86	100,00	106	56	66	65	12	32	1,300	
66 AT10/36-2	36	6F	Al	114,59	112,75	119	56	66	70	16	35	1,637	
66 AT10/40-2	40	6F	Al	127,32	125,45	131	56	66	80	16	40	1,999	
66 AT10/44-0	44	6	Al	140,06	138,20	—	56	66	88	16	46	2,357	
66 AT10/48-0	48	6	Al	152,78	150,95	—	56	66	95	16	48	2,830	
66 AT10/60-0	60	6	Al	190,98	189,10	—	56	66	110	16	60	4,366	

Al = Aluminium

Fertigungstechnische Änderungen vorbehalten. *We reserve the right to make technical changes.*

Standard-Zahnwellen

Timing bars – standard timing belts

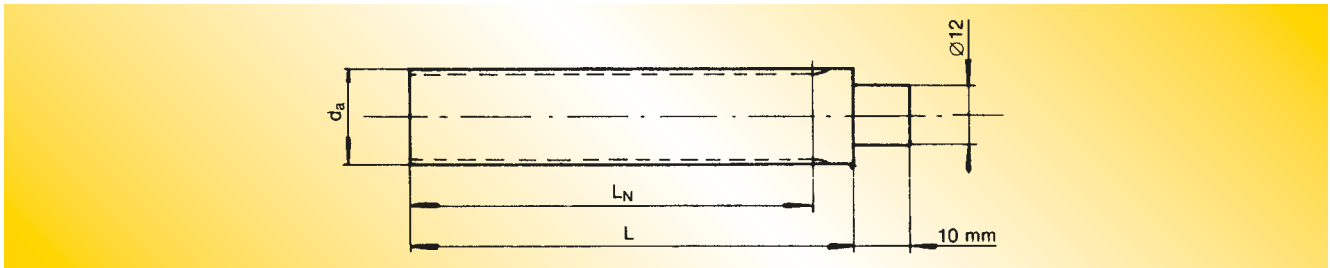

Type XL – Teilung *Pitch* 5,08 mm (1/5")

Bezeichnung Part No.	Anzahl der Zähne No. of teeth	Material	d_d (mm)	d_a (mm)	L_N (mm)	L (mm)	€ Stück each
10 XL 125	10	St	16,17	15,66	125	140	auf Anfrage on request
11 XL 125	11	St	17,79	17,28	125	140	
12 XL 125	12	St	19,40	18,89	125	140	
13 XL 125	13	St	21,02	20,51	125	140	
14 XL 132	14	St	22,64	22,13	132	140	
15 XL 132	15	St	24,26	23,75	132	140	
16 XL 140	16	St	25,87	25,36	140	140	
17 XL 140	17	St	27,49	26,98	140	140	
18 XL 140	18	St	29,11	28,60	140	140	
19 XL 140	19	St	30,72	30,21	140	140	
20 XL 140	20	St	32,34	31,83	140	140	
21 XL 160	21	St	33,96	33,45	160	160	
22 XL 160	22	St	35,57	35,06	160	160	
23 XL 160	23	St	37,19	36,68	160	160	
24 XL 160	24	St	38,81	38,30	160	160	
25 XL 160	25	St	40,43	39,92	160	160	
26 XL 160	26	St	42,04	41,53	160	160	
27 XL 160	27	St	43,66	43,15	160	160	
28 XL 160	28	St	45,28	44,77	160	160	
29 XL 160	29	St	46,89	46,38	160	160	
30 XL 160	30	St	48,51	48,00	160	160	
32 XL 160	32	Al	51,74	51,23	160	160	
33 XL 160	33	Al	53,36	52,76	160	160	
34 XL 160	34	Al	54,98	54,47	160	160	
35 XL 160	35	Al	56,60	56,09	160	160	
36 XL 160	36	Al	58,21	57,70	160	160	
38 XL 160	38	Al	61,45	60,94	160	160	
39 XL 160	39	Al	63,06	62,55	160	160	
40 XL 160	40	Al	64,68	64,17	160	160	
41 XL 160	41	Al	66,30	65,79	160	160	
42 XL 160	42	Al	67,91	67,40	160	160	
43 XL 160	43	Al	69,53	69,02	160	160	
44 XL 160	44	Al	71,15	70,64	160	160	
48 XL 160	48	Al	77,62	77,11	160	160	
56 XL 160	56	Al	90,55	90,04	160	160	
60 XL 160	60	Al	97,02	96,51	160	160	
72 XL 160	72	Al	116,43	115,92	160	160	

Standard-Zahnwellen Timing bars – standard timing belts

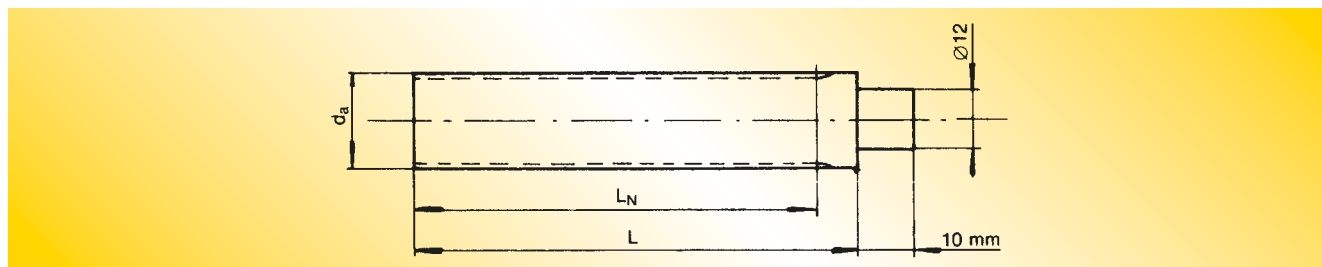

Type L – Teilung *Pitch* 9,525 mm ($\frac{3}{8}$ ")

Bezeichnung Part No.	Anzahl der Zähne No. of teeth	Material	d_d (mm)	d_s (mm)	L_N (mm)	L (mm)	€ Stück each
10 L 140	10	St	30,32	29,56	140	140	auf Anfrage on request
11 L 140	11	St	33,35	32,59	140	140	
12 L 160	12	St	36,38	35,62	160	160	
13 L 160	13	St	39,41	38,65	160	160	
14 L 160	14	St	42,45	41,68	160	160	
15 L 160	15	St	45,48	44,72	160	160	
16 L 160	16	St	48,51	47,75	160	160	
17 L 160	17	St	51,54	50,78	160	160	
18 L 160	18	St	54,57	53,81	160	160	
19 L 160	19	St	57,61	56,84	160	160	
20 L 160	20	St	60,64	59,88	160	160	
21 L 160	21	St	63,67	62,91	160	160	
22 L 160	22	St	66,70	65,94	160	160	
23 L 160	23	St	69,73	68,97	160	160	
24 L 160	24	St	72,77	72,00	160	160	
27 L 160	27	St	81,86	81,10	160	160	
30 L 160	30	St	90,96	90,20	160	160	

70

Metrische Zahnwellen Timing bars – metric timing belts

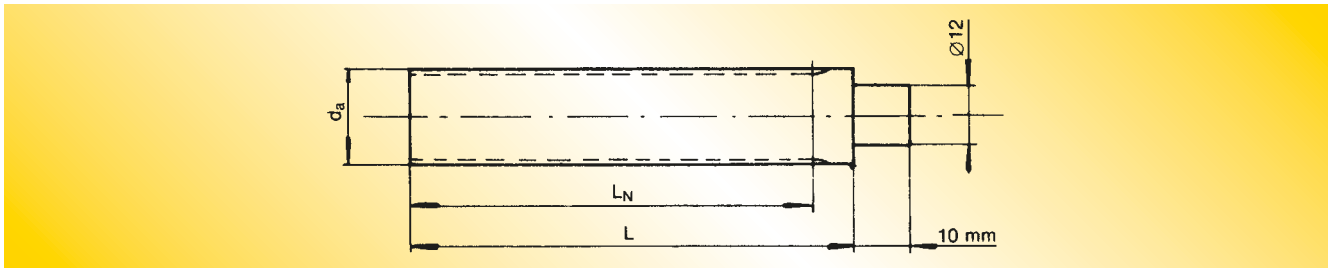

Type T5 – Teilung *Pitch* 5 mm

Bezeichnung Part No.	Anzahl der Zähne No. of teeth	Material	d_d (mm)	d_a (mm)	L_N (mm)	L (mm)	€ Stück each
125 T5- 10	10	Al	15,92	15,05	125	140	auf Anfrage on request
125 T5- 11	11	Al	17,51	16,65	125	140	
125 T5- 12	12	Al	19,01	18,25	125	140	
125 T5- 13	13	Al	20,70	19,85	125	140	
132 T5- 14	14	Al	22,29	21,45	132	140	
132 T5- 15	15	Al	23,88	23,05	132	140	
140 T5- 16	16	Al	25,47	24,60	140	140	
140 T5- 17	17	Al	27,06	26,20	140	140	
140 T5- 18	18	Al	28,65	27,80	140	140	
140 T5- 19	19	Al	30,25	29,40	140	140	
160 T5- 20	20	Al	31,83	31,00	160	160	
160 T5- 21	21	Al	33,43	32,70	160	160	
160 T5- 22	22	Al	35,12	34,25	160	160	
160 T5- 23	23	Al	36,62	35,85	160	160	
160 T5- 24	24	Al	38,21	37,40	160	160	
160 T5- 25	25	Al	39,80	39,00	160	160	
160 T5- 26	26	Al	41,47	40,60	160	160	
160 T5- 27	27	Al	42,98	42,20	160	160	
160 T5- 28	28	Al	44,62	43,75	160	160	
160 T5- 29	29	Al	46,17	45,35	160	160	
160 T5- 30	30	Al	47,76	46,95	160	160	
160 T5- 32	32	Al	50,94	50,10	160	160	
160 T5- 34	34	Al	54,13	53,25	160	160	
160 T5- 35	35	Al	55,72	54,85	160	160	
160 T5- 36	36	Al	57,31	56,45	160	160	
160 T5- 37	37	Al	58,90	58,06	160	160	
160 T5- 38	38	Al	60,50	59,65	160	160	
160 T5- 40	40	Al	63,66	62,85	160	160	
160 T5- 42	42	Al	66,87	66,00	160	160	
160 T5- 44	44	Al	70,07	69,20	160	160	
160 T5- 45	45	Al	71,64	70,80	160	160	
160 T5- 46	46	Al	73,23	72,40	160	160	
160 T5- 48	48	Al	76,42	75,55	160	160	
160 T5- 50	50	Al	79,60	78,75	160	160	
160 T5- 60	60	Al	95,52	94,65	160	160	
160 T5- 72	72	Al	114,62	113,75	160	160	
160 T5- 80	80	Al	127,36	126,48	160	160	
160 T5- 90	90	Al	143,28	142,40	160	160	
160 T5-100	100	Al	159,20	158,31	160	160	

Metrische Zahnwellen Timing bars – metric timing belts

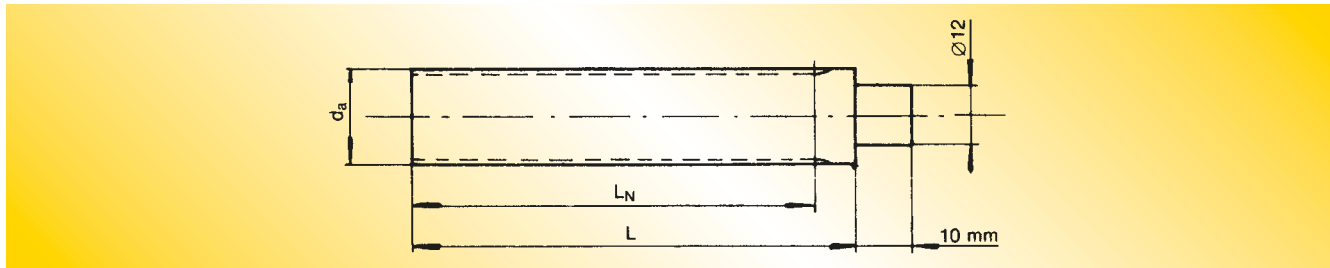

Type T10 – Teilung *Pitch* 10 mm

Bezeichnung Part No.	Anzahl der Zähne No. of teeth	Material	d_d (mm)	d_s (mm)	L_N (mm)	L (mm)	€ Stück each
140 T10-10	10	Al	31,83	29,98	140	140	auf Anfrage on request
140 T10-11	11	Al	35,01	33,16	140	140	
140 T10-12	12	Al	38,20	36,35	140	140	
140 T10-13	13	Al	41,38	39,50	140	140	
160 T10-14	14	Al	44,56	42,70	160	160	
160 T10-15	15	Al	47,75	45,90	160	160	
160 T10-16	16	Al	50,93	49,05	160	160	
160 T10-17	17	Al	54,11	52,25	160	160	
160 T10-18	18	Al	57,29	55,45	160	160	
160 T10-19	19	Al	60,48	58,60	160	160	
160 T10-20	20	Al	63,66	61,60	160	160	
160 T10-21	21	Al	66,84	65,00	160	160	
160 T10-22	22	Al	70,03	68,15	160	160	
160 T10-23	23	Al	73,20	71,35	160	160	
160 T10-24	24	Al	76,39	74,55	160	160	
160 T10-26	26	Al	82,76	80,90	160	160	
160 T10-28	28	Al	89,13	87,25	160	160	
160 T10-30	30	Al	95,49	93,65	160	160	
160 T10-32	32	Al	101,86	100,00	160	160	
160 T10-34	34	Al	108,22	106,40	160	160	
160 T10-36	36	Al	114,59	112,75	160	160	
160 T10-38	38	Al	120,95	119,10	160	160	
160 T10-40	40	Al	127,32	125,45	160	160	
160 T10-45	45	Al	143,24	141,40	160	160	
160 T10-48	48	Al	152,78	150,95	160	160	
160 T10-60	60	Al	190,98	189,10	160	160	
160 T10-72	72	Al	229,18	227,29	160	160	

Einfach-Rollenketten nach DIN 8187-1 (europäische Bauart) entsprechend ISO 606



Simplex roller chains according to DIN 8187-1 (European type) corresponding to ISO 606

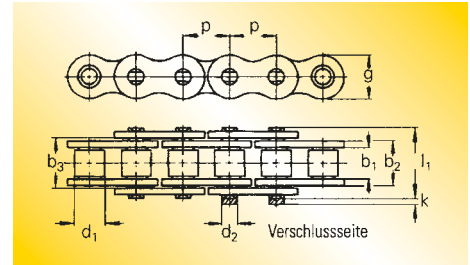

	Teilung		Innere Breite	Innen-glied-breite	Breite zw. AL	Rollen-Ø	Bolzen-Ø	La-schen-höhe	Über-stand	Maß über Bolzen	Gelenk-fläche	Bruch-kraft DIN	Bruch-kraft	Ge-wicht	Ver-bindungs-glieder	Kette
	Pitch		Inner width	Inner link width	Outer plate width	Roller Ø	Pin Ø	Plate height	Projection over connecting link	Width over pin	Bearing area	Minimum tensile strength DIN	Minimum tensile strength	Weight	Connecting links	Chain
DIN	P		b ₁ min.	b ₂ max.	b ₃ min.	d ₁ max.	d ₂ max.	g max.	k max.	l ₁ max.	f	F _B min.	F _B min.	q ≈		
Nr. No.	mm	inch	mm	mm	mm	mm	mm	mm	mm	mm	cm ²	kN	kN	kg/m	Nr. No.	€/m
03	5,0	–	2,50	4,15	4,25	3,20	1,49	4,1	2,5	7,4	0,06	2,2	2,2	0,08	11,15	
04	6,0	–	2,80	4,10	4,20	4,00	1,85	5,0	2,9	7,4	0,08	3,0	3,0	0,15	11,15	
05 B-1	8,0	–	3,00	4,77	4,90	5,00	2,31	7,1	3,1	8,6	0,11	5,0	5,5	0,18	11,15	
–	9,525	3/8	3,30	5,45	5,58	6,00	2,78	9,0	3,1	9,6	0,15	8,0	8,2	0,26	11,15,111	
–	9,525	3/8	3,94	6,70	6,83	6,35	3,28	9,0	3,3	11,6	0,22	9,0	9,4	0,36	11,12,15	
06 B-1	9,525	3/8	5,72	8,53	8,66	6,35	3,28	8,2	3,3	13,5	0,28	9,0	9,6	0,41	11,12,15	
081	12,7	1/2	3,30	5,80	5,93	7,75	3,66	9,9	1,5	10,2	0,21	8,2	9,1	0,28	11,12,15	
–	12,7	1/2	4,88	7,20	7,33	7,75	3,66	9,9	1,5	11,2	0,26	8,2	9,1	0,33	11,12,15	
082	12,7	1/2	2,38	4,60	4,73	7,75	3,66	9,9	–	8,2	0,17	10,0	10,0	0,26	15,111	
083	12,7	1/2	4,88	7,90	8,03	7,75	4,09	10,3	1,5	12,9	0,32	12,0	13,2	0,42	11,12,15	
–	12,7	1/2	6,40	9,78	9,91	7,75	3,97	11,5	3,9	15,4	0,38	16,0	17,1	0,50	11,12,15	
–	12,7	1/2	6,40	9,93	10,06	8,51	4,45	11,8	3,9	15,8	0,44	18,0	18,6	0,66	11,12,15	
08 B-1	12,7	1/2	7,75	11,30	11,43	8,51	4,45	11,8	3,9	17,0	0,50	18,0	18,6	0,70	11,12,15	
–	15,875	5/8	6,48	10,08	10,21	10,16	5,08	14,7	4,1	16,4	0,51	22,4	27,5	0,78	11,12,15	
10 B-1	15,875	5/8	9,65	13,28	13,41	10,16	5,08	14,7	4,1	19,6	0,67	22,4	27,0	0,91	11,12,15	
12 B-1	19,05	3/4	11,68	15,62	15,75	12,07	5,72	16,1	4,6	22,7	0,89	29,0	31,0	1,18	11,12,15	
16 B-1	25,4	1	17,02	25,40	25,60	15,88	8,28	21,0	5,4	36,1	2,10	60,0	72,0	2,68	11,111,12	
–	30,0	–	17,02	25,40	25,60	15,88	8,28	21,0	5,4	36,1	2,10	60,0	72,0	2,50	11,111,12	
20 B-1	31,75	1 1/4	19,56	29,00	29,20	19,05	10,19	26,4	6,1	43,2	2,96	95,0	105,0	3,50	11,111,12	
24 B-1	38,1	1 1/2	25,40	37,90	38,20	25,40	14,63	33,4	6,6	53,4	5,54	160,0	180,0	6,80	111,12	
28 B-1	44,45	1 3/4	30,99	46,50	46,80	27,94	15,90	37,0	7,4	65,1	7,39	200,0	230,0	8,50	111,12	
32 B-1	50,8	2	30,99	45,50	45,80	29,21	17,81	42,2	7,9	67,4	8,10	250,0	276,0	10,50	111,12	
40 B-1	63,5	2 1/2	38,10	55,70	56,00	39,37	22,89	52,9	10,0	82,6	12,75	355,0	405,0	16,40	111,12	
48 B-1	76,2	3	45,72	70,50	71,00	48,26	29,24	63,8	10,0	99,1	20,61	560,0	630,0	25,00	111,12	

auf Anfrage
on request

Galvanisch verzinkte oder vernickelte Ketten auf Anfrage. Hier darf nur mit 80% der Bruchlast gerechnet werden.
Electrogalvanised or nickel-plated chains on request. In this case chains may only have 80% of the tensile strength.

Verbindungs-glieder: Bezeichnung nach DIN

Connecting links: description according to DIN

Nr. 4 (B) Innenglied <i>Inner link</i>	Nr. 7 (A) Außenglied (Nietglied) Outer link (to be rivetted)	Nr. 11 (E) Verbindungsglied mit Feder Spring clip connecting link	Nr. 111 (S) Verbindungsglied mit Splinten Connecting link with cottered pin	Nr. 12 (L) Gekröpftes Glied mit Splint Single cranked link	Nr. 15 (C) Gekröpftes Doppelglied Double cranked link

Zweifach-Rollenketten nach DIN 8187-1 (europäische Bauart) entsprechend ISO 606 Duplex roller chains according to DIN 8187-1 (European type) corresponding to ISO 606

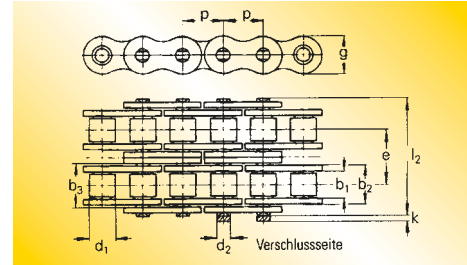

	Teilung	Innere Breite	Innengliedbreite	Breite zw. AL	Rollen-Ø	Bolzen-Ø	Quer- teilung	La- schen- höhe	Über- stand	Maß über Bolzen	Ge- lenk- fläche	Bruch- kraft DIN	Bruch- kraft ⚙️	Ge- wicht	Ver- bindungs- glieder	Kette
	Pitch	Inner width	Inner link width	Outer plate width	Roller Ø	Pin Ø	Trans- verse pitch	Plate height	Projec- tion over connec- ting link	Width over pin	Bearing area	Minimum tensile strength DIN	Minimum tensile strength ⚙️	Weight	Connec- ting links	Chain
DIN	P	b ₁ min.	b ₂ max.	b ₃ min.	d ₁ max.	d ₂ max.	e	g max.	k max.	l ₂ max.	f	F _B min.	F _B min.	q ≈		
Nr. No.	mm inch	mm	mm	mm	mm	mm	mm	mm	mm	mm	cm ²	kN	kN	kg/m	Nr. No..	€/m
-	6,0 -	2,80	4,10	4,25	4,00	1,85	5,50	5,0	2,9	13,3	0,14	5,0	5,0	0,23	11,15	
05 B-2	8,0 -	3,00	4,77	4,90	5,00	2,31	5,64	7,1	3,1	14,3	0,22	7,8	8,2	0,36	11,15	
06 B-2	9,525 3/8	5,72	8,53	8,66	6,35	3,28	10,24	8,2	3,3	23,8	0,56	16,9	17,4	0,78	11,12,15	
08 B-2	12,7 1/2	7,75	11,30	11,43	8,51	4,45	13,92	11,8	3,9	31,0	1,01	32,0	37,0	1,36	11,12,15	
10 B-2	15,875 5/8	9,65	13,28	13,41	10,16	5,08	16,59	14,7	4,1	36,2	1,34	44,5	54,0	1,82	11,12,15	
12 B-2	19,05 3/4	11,68	15,62	15,75	12,07	5,72	19,46	16,1	4,6	42,2	1,79	57,8	63,0	2,38	11,12,15	
16 B-2	25,4 1	17,02	25,40	25,60	15,88	8,28	31,88	21,0	5,4	68,0	4,21	106,0	140,0	5,30	11,111,12	
20 B-2	31,75 1 1/4	19,56	29,00	29,20	19,05	10,19	36,45	26,4	6,1	79,0	5,91	170,0	210,0	7,30	11,111,12	
24 B-2	38,1 1 1/2	25,40	37,90	38,20	25,40	14,63	48,36	33,4	6,6	101,0	11,09	280,0	360,0	13,40	111,12	
28 B-2	44,45 1 3/4	30,99	46,50	46,80	27,94	15,90	59,56	37,0	7,4	124,0	14,79	360,0	443,0	16,60	111,12	
32 B-2	50,8 2	30,99	45,50	45,80	29,21	17,81	58,55	42,2	7,9	126,0	16,21	450,0	530,0	21,00	111,12	
40 B-2	63,5 2 1/2	38,10	55,70	56,00	39,37	22,89	72,29	52,9	10,0	154,0	25,50	630,0	806,0	32,60	111,12	
48 B-2	76,2 3	45,72	70,50	71,00	48,26	29,24	91,21	63,8	10,0	190,0	41,23	1000,0	1100,0	50,00	111,12	

auf
Anfrage
on
request

Galvanisch verzinkte oder vernickelte Ketten auf Anfrage. Hier darf nur mit 80% der Bruchlast gerechnet werden.
Electrogalvanised or nickel-plated chains on request. In this case chains may only have 80% of the tensile strength.

Verbindungsglieder: Bezeichnung nach DIN

Connecting links: description according to DIN



Nr. 4 (B)
Innenglied
Inner link



Nr. 7 (A)
Außenglied
(Nietglied)
Outer link
(to be rivetted)



Nr. 11 (E)
Verbindungsglied
mit Feder
Spring clip
connecting link



Nr. 111 (S)
Verbindungsglied
mit Splinten
Connecting link
with cottered pin



Nr. 12 (L)
Gekröpftes Glied
mit Splint
Single cranked link



Nr. 15 (C)
Gekröpftes
Doppelglied
Double cranked link

Dreifach-Rollenketten nach DIN 8187-1 (europäische Bauart) entsprechend ISO 606 *Triplex roller chains according to DIN 8187-1 (European type) corresponding to ISO 606*

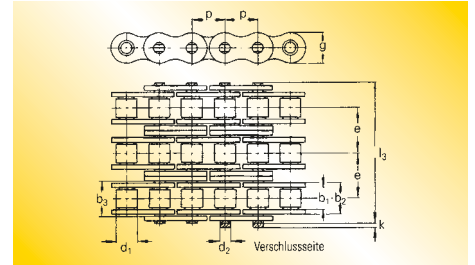
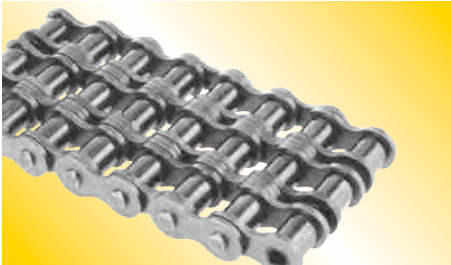

	Teilung		Innere Breite	Innengliedbreite	Breite zw. AL	Roller-Ø	Bolzen-Ø	Quer- teilung	La- schen- höhe	Über- stand	Maß über Bolzen	Ge- lenk- fläche	Bruch- kraft DIN	Bruch- kraft 	Ge- wicht	Ver- bindungs- glieder	Kette
	Pitch		Inner width	Inner link width	Outer plate width	Roller Ø	Pin Ø	Trans- verse pitch	Plate height	Projec- tion over connect- ing link	Width over pin	Bearing area	Minimum tensile strength DIN	Minimum tensile strength 	Weight	Connect- ing links	Chain
DIN	P		b ₁ min.	b ₂ max.	b ₃ min.	d ₁ max.	d ₂ max.	e	g max.	k max.	l ₃ max.	f	F _B min.	F _B min.	q ≈		
Nr. No.	mm	inch	mm	mm	mm	mm	mm	mm	mm	mm	mm	cm ²	kN	kN	kg/m	Nr. No.	€/m
05 B-3	8,0	–	3,00	4,77	4,90	5,00	2,31	5,64	7,1	3,1	19,9	0,33	11,1	11,1	0,54	11,15	auf Anfrage on request
06 B-3	9,525	3/8	5,72	8,53	8,66	6,35	3,28	10,24	8,2	3,3	34,0	0,81	24,9	24,9	1,18	11,12,15	
08 B-3	12,7	1/2	7,75	11,30	11,43	8,51	4,45	13,92	11,8	3,9	44,9	1,51	47,5	56,0	2,01	11,12,15	
10 B-3	15,875	5/8	9,65	13,28	13,41	10,16	5,08	16,59	14,7	4,1	52,8	2,02	66,7	80,0	2,70	11,12,15	
12 B-3	19,05	3/4	11,68	15,62	15,75	12,07	5,72	19,46	16,1	4,6	61,7	2,68	86,7	94,0	3,12	11,12,15	
16 B-3	25,4	1	17,02	25,40	25,60	15,88	8,28	31,88	21,0	5,4	99,9	6,31	160,0	211,0	7,50	11,111,12	
20 B-3	31,75	1 1/4	19,56	29,00	29,20	19,05	10,19	36,45	26,4	6,1	116,0	8,87	250,0	300,0	10,60	11,111,12	
24 B-3	38,1	1 1/2	25,40	37,90	38,20	25,40	14,63	48,36	33,4	6,6	150,0	16,63	425,0	523,0	20,00	111,12	
28 B-3	44,45	1 3/4	30,99	46,50	46,80	27,94	15,90	59,56	37,0	7,4	184,0	22,18	530,0	660,0	25,00	111,12	
32 B-3	50,8	2	30,99	45,50	45,80	29,21	17,81	58,55	42,2	7,9	184,0	24,31	670,0	800,0	32,00	111,12	
40 B-3	63,5	2 1/2	38,10	55,70	56,00	39,37	22,89	72,29	52,9	10,0	227,0	38,25	950,0	1140,0	48,70	111,12	
48 B-3	76,2	3	45,72	70,50	71,00	48,26	29,24	91,21	63,8	10,0	281,0	61,84	1500,0	1720,0	75,00	111,12	

Galvanisch verzinkte oder vernickelte Ketten auf Anfrage. Hier darf nur mit 80% der Bruchlast gerechnet werden.
Electrogalvanised or nickel-plated chains on request. In this case chains may only have 80% of the tensile strength.

Verbindungsglieder: Bezeichnung nach DIN

Connecting links: description according to DIN



Nr. 4 (B)
Innenglied
Inner link



Nr. 7 (A)
Außenglied
(Nietglied)
*Outer link
(to be rivetted)*



Nr. 11 (E)
Verbindungsglied
mit Feder
*Spring clip
connecting link*



Nr. 111 (S)
Verbindungsglied
mit Splinten
*Connecting link
with cottered pin*



Nr. 12 (L)
Gekröpftes Glied
mit Splint
Single cranked link



Nr. 15 (C)
Gekröpftes
Doppelglied
Double cranked link

Einfach-Rollenketten nach DIN 8188-1 (amerikanische Bauart) entsprechend ISO 606 Simplex roller chains according to DIN 8188-1 (American type) corresponding to ISO 606

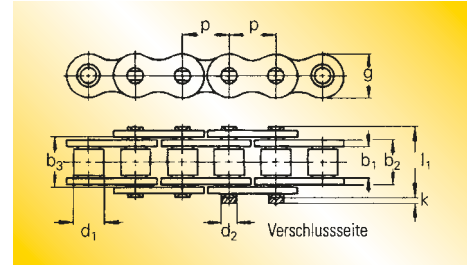

Kette		Teilung		Innere Breite	Innengliedbreite	Breite zw. AL	Rollen-Ø	Bolzen-Ø	Laschenhöhe	Überstand	Maß über Bolzen	Gelenkfläche	Bruchkraft DIN	Bruchkraft	Gewicht	Verbindungsglieder	Kette	
Chain		Pitch		Inner width	Inner link width	Outer plate width	Roller Ø	Pin Ø	Plate height	Projection over connecting link	Width over pin	fläche Bearing area	Minimum tensile strength DIN	Minimum tensile strength	Weight	Connecting links	Chain	
	DIN	P		b ₁ min.	b ₂ max.	b ₃ min.	d ₁ max.	d ₂ max.	g max.	k max.	l ₁ max.	f cm ²	F _B min. kN	F _B min. kN	q ≈ kg/m			
Nr. No.	Incl.	Nr. No.	mm	inch	mm	mm	mm	mm	mm	mm	mm	cm ²	kN	kN	kg/m	Nr. No.	€/m*	
25	²	04C-1	6,35	1/4	3,18	4,80	4,85	3,30	2,31	6,0	2,5	9,0	0,11	3,5	3,5	0,13	11,15	auf Anfrage on request
35	²	06C-1	9,525	3/8	4,68	7,47	7,52	5,08	3,58	9,1	3,3	13,2	0,27	7,9	10,2	0,35	11,12,15	
40		08A-1	12,7	1/2	7,85	11,15	11,28	7,95	3,96	12,0	3,9	17,8	0,44	14,1	16,5	0,60	11,12,15	
50		10A-1	15,875	5/8	9,40	13,80	13,93	10,16	5,08	15,0	4,1	21,8	0,70	22,2	30,0	1,01	11,12,15	
60	⁹	12A-1	19,05	3/4	12,57	17,70	17,85	11,91	5,94	18,0	4,6	26,9	1,05	31,8	40,0	1,58	11,111,12,15	
80	⁹	16A-1	25,4	1	15,75	22,50	22,70	15,88	7,92	24,1	5,4	33,5	1,78	56,7	69,0	2,36	11,111,12	
100	⁹	20A-1	31,75	1 1/4	18,90	27,40	27,60	19,05	9,53	30,1	6,1	41,1	2,61	88,5	92,5	3,80	111,12	
120	⁹	24A-1	38,1	1 1/2	25,22	35,30	35,60	22,23	11,10	36,2	6,6	50,8	3,92	127,0	139,0	5,40	111,12	
140	⁹	28A-1	44,45	1 3/4	25,22	37,00	37,30	25,40	12,70	42,2	7,4	54,9	4,70	172,4	178,5	7,30	111,12	
160	⁹	32A-1	50,8	2	31,55	45,00	45,30	28,58	14,27	48,2	7,9	65,5	6,42	226,8	231,0	9,90	111,12	
200	⁹	40A-1	63,5	2 1/2	37,85	54,70	55,00	39,68	19,84	60,3	10,0	80,3	10,85	353,8	387,0	16,50	111,12	

Schwere Ausführung mit verstärkten Laschen und vergrößerten Gelenkflächen Heavy duty design with reinforced side plates and enlarged bearing areas

50 H	–	15,875	5/8	9,40	14,60	14,73	10,16	5,08	15,0	4,1	23,4	0,75	22,2	32,0	1,18	11	auf Anfrage on request
60 H	⁹	19,05	3/4	12,57	19,45	19,60	11,91	5,94	18,0	4,6	28,9	1,16	31,8	42,0	1,94	11	
80 H	⁹	25,4	1	15,75	24,28	24,48	15,88	7,92	24,1	5,4	37,0	1,92	56,7	72,0	3,04	111	
100 H	⁹	31,75	1 1/4	18,90	29,10	29,30	19,05	9,53	30,1	6,1	44,0	2,77	88,5	96,0	4,25	111	
120 H	⁹	38,1	1 1/2	25,22	37,00	37,30	22,23	11,10	36,2	6,6	54,0	4,13	127,0	141,0	6,40	111	
140 H	⁹	44,45	1 3/4	25,22	38,70	39,00	25,40	12,70	42,2	7,4	58,0	4,94	172,4	180,0	8,30	111	
160 H	⁹	50,8	2	31,55	46,90	47,20	28,58	14,27	48,2	7,9	68,0	6,70	226,8	233,0	11,50	111	
200 H	⁹	63,5	2 1/2	37,85	57,60	57,90	39,68	19,84	60,3	10,0	84,0	11,60	353,8	400,0	20,00	111	

Galvanisch verzinkte oder vernickelte Ketten auf Anfrage. Hier darf nur mit 80% der Bruchlast gerechnet werden.
Electrogalvanised or nickel-plated chains on request. In this case chains may only have 80% of the tensile strength.

* Preise gelten für vernietete Ketten. Prices are valid for rivetted chains.

² ohne Rollen (DIN 8154) without rolls (DIN 8154)

⁹ in zerlegbarer (versplinteter) Ausführung auf Anfrage available as resolvable (cotted) construction on request

Verbindungsglieder: Bezeichnung nach DIN

Connecting links: description according to DIN



Zweifach-Rollenketten nach DIN 8188-1 (amerikanische Bauart) entsprechend ISO 606 Duplex roller chains according to DIN 8188-1 (American type) corresponding to ISO 606

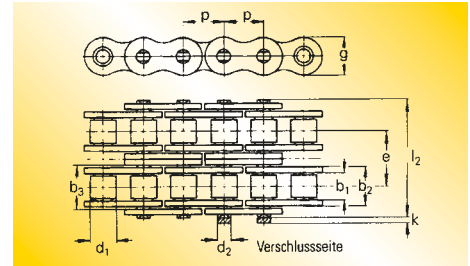

Kette		Teilung		Innere Breite	Innengliedbreite	Breite zw. AL	Rollen-Ø	Bolzen-Ø	Quer-teilung	La-schenhöhe	Über-stand	Maß über Bolzen	Ge-lenk-fläche	Bruch-kraft DIN	Bruch-kraft	Ge-wicht	Ver-bindungs-glieder	Kette	
Chain		Pitch	Inner width	Inner link width	Outer plate width	Roller Ø	Pin Ø	Trans-verse pitch	Plate height	Projec-tion over connect-ing link	Width over pin	Bearing area	Minimum tensile strength DIN	Minimum tensile strength	Weight	Connec-tion links	Chain		
⚙	DIN	P	b ₁ min.	b ₂ max.	b ₃ min.	d ₁ max.	d ₂ max.	e	g max.	k max.	l ₂ max.	f	F _B min.	F _B min.	q ≈				
Nr. No.	Ind.	Nr. No.	mm	inch	mm	mm	mm	mm	mm	mm	mm	mm	cm ²	kN	kN	kg/m	Nr. No.	€/m*	
35-2	²	06C-2	9,525	3/8	4,68	7,47	7,52	5,08	3,58	10,13	9,0	3,3	23,4	0,53	15,8	17,0	0,70	11,12,15	auf Anfrage on request
40-2		08A-2	12,7	1/2	7,85	11,15	11,28	7,95	3,96	14,38	12,0	3,9	32,3	0,88	28,2	29,7	1,20	11,12,15	
50-2		WA-2	15,875	5/8	9,40	13,80	13,93	10,16	5,08	18,11	15,0	4,1	39,9	1,40	44,4	62,0	1,78	11,12,15	
60-2	⁹	12A-2	19,05	3/4	12,57	17,70	17,85	11,91	5,94	22,78	18,0	4,6	49,8	2,10	63,6	76,0	3,15	11,111,12,15	
80-2	⁹	16A-2	25,4	1	15,75	22,50	22,70	15,88	7,92	29,29	24,1	5,4	62,7	3,56	113,4	135,0	4,90	11,111,12,15	
100-2	⁹	20A-2	31,75	1 1/4	18,90	27,40	27,60	19,05	9,53	35,76	30,1	6,1	77,0	5,22	177,0	205,0	7,60	111,12	
120-2	⁹	24A-2	38,1	1 1/2	25,22	35,30	35,60	22,23	11,10	45,44	36,2	6,6	96,3	7,84	254,0	290,0	10,80	111,12	
140-2	⁹	28A-2	44,45	1 3/4	25,22	37,00	37,30	25,40	12,70	48,87	42,2	7,4	103,0	9,40	344,8	357,0	14,30	111,12	
160-2	⁹	32A-2	50,8	2	31,55	45,00	45,30	28,58	14,27	58,55	48,2	7,9	124,0	12,84	453,6	455,0	19,40	111,12	
200-2	⁹	40A-2	63,5	2 1/2	37,85	54,70	55,00	39,68	19,84	71,55	60,3	10,0	151,0	21,70	707,6	730,0	33,00	111,12	

Galvanisch verzinkte oder vernickelte Ketten auf Anfrage. Hier darf nur mit 80% der Bruchlast gerechnet werden.
Electrogalvanised or nickel-plated chains on request. In this case chains may only have 80% of the tensile strength.

* Preise gelten für vernietete Ketten. Prices are valid for rivetted chains.

² ohne Rollen (DIN 8154) without rolls (DIN 8154)

⁹ in zerlegbarer (versplinteter) Ausführung auf Anfrage available as resolvable (cottered) construction on request

Verbindungsglieder: Bezeichnung nach DIN

Connecting links: description according to DIN



Nr. 4 (B)
Innenglied
Inner link



Nr. 7 (A)
Außenglied
(Nietglied)
Outer link
(to be rivetted)



Nr. 11 (E)
Verbindungsglied
mit Feder
Spring clip
connecting link



Nr. 111 (S)
Verbindungsglied
mit Splinten
Connecting link
with cottered pin



Nr. 12 (L)
Gekröpftes Glied
mit Splint
Single cranked link



Nr. 15 (C)
Gekröpftes
Doppelglied
Double cranked link

Dreifach-Rollenketten nach DIN 8188-1 (amerikanische Bauart) entsprechend ISO 606 Triplex roller chains according to DIN 8188-1 (American type) corresponding to ISO 606

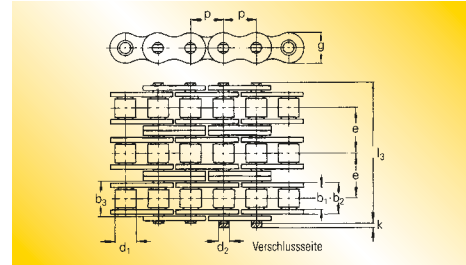
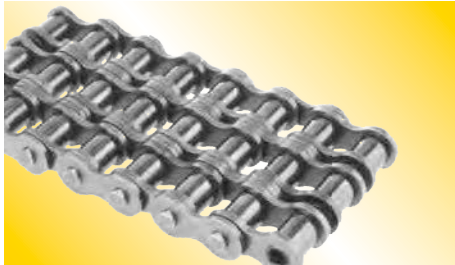

Kette		Teilung		Innere Breite	Innengliedbreite	Breite zw. AL	Rollen-Ø	Bolzen-Ø	Quer-teilung	La-schen-höhe	Über-stand	Maß über Bolzen	Ge-lenk-fläche	Bruch-kraft DIN	Bruch-kraft	Ge-wicht	Ver-bindungs-glieder	Kette	
Chain		Pitch		Inner width	Inner link width	Outer plate width	Roller Ø	Pin Ø	Transverse pitch	Plate height	Projection over connecting link	Width over pin	Bearing area	Minimum tensile strength DIN	Minimum tensile strength	Weight	Connecting links	Chain	
☼		DIN	P	b ₁ min.	b ₂ max.	b ₃ min.	d ₁ max.	d ₂ max.	e	g max.	k max.	l ₂ max.	f cm ²	F _B min. kN	F _B min. kN	q ≈ kg/m	Nr. No.		
Nr. No.	Incl.	Nr. No.	mm	inch	mm	mm	mm	mm	mm	mm	mm	mm	cm ²	kN	kN	kg/m	Nr. No.	€/m*	
35-3	²	06C-3	9,525	3/8	4,68	7,47	7,52	5,08	3,58	10,13	9,0	3,3	33,5	0,80	23,7	25,5	1,05	11,12,15	auf Anfrage on request
40-3		08A-3	12,7	1/2	7,85	11,15	11,28	7,95	3,96	14,38	12,0	3,9	46,7	1,32	42,3	41,2	1,80	11,12,15	
50-3		10A-3	15,875	5/8	9,40	13,80	13,93	10,16	5,08	18,11	15,0	4,1	57,9	2,10	66,6	88,0	3,02	11,12,15	
60-3	⁹	12A-3	19,05	3/4	12,57	17,70	17,85	11,91	5,94	22,78	18,0	4,6	72,6	3,15	95,4	105,0	4,70	11,111,12,15	
80-3	⁹	16A-3	25,4	1	15,75	22,50	22,70	15,88	7,92	29,29	24,1	5,4	91,7	5,35	170,1	193,0	7,50	11,111,12,15	
100-3	⁹	20A-3	31,75	1 1/4	18,90	27,40	27,60	19,05	9,53	35,76	30,1	6,1	113,0	7,83	265,5	305,0	11,20	111,12	
120-3	⁹	24A-3	38,1	1 1/2	25,22	35,30	35,60	22,23	11,10	45,44	36,2	6,6	141,0	11,76	381,0	410,0	16,10	111,12	
140-3	⁹	28A-3	44,45	1 3/4	25,22	37,00	37,30	25,40	12,70	48,87	42,2	7,4	152,0	14,10	517,2	520,0	21,40	111,12	
160-3	⁹	32A-3	50,8	2	31,55	45,00	45,30	28,58	14,27	58,55	48,2	7,9	182,0	19,26	680,4	685,0	29,10	111,12	
200-3	⁹	40A-3	63,5	2 1/2	37,85	54,70	55,00	39,68	19,84	71,55	60,3	10,0	223,0	32,56	1061,4	1095,0	50,00	111,12	

Galvanisch verzinkte oder vernickelte Ketten auf Anfrage. Hier darf nur mit 80% der Bruchlast gerechnet werden.
Electrogalvanised or nickel-plated chains on request. In this case chains may only have 80% of the tensile strength.

* Preise gelten für vernietete Ketten. Prices are valid for rivetted chains.

² ohne Rollen (DIN 8154) without rolls (DIN 8154)

⁹ in zerlegbarer (versplinteter) Ausführung auf Anfrage available as resolvable (cotted) construction on request

Verbindungsglieder: Bezeichnung nach DIN

Connecting links: description according to DIN



Nr. 4 (B)
Innenglied
Inner link



Nr. 7 (A)
Außenglied
(Nietglied)
Outer link
(to be rivetted)



Nr. 11 (E)
Verbindungsglied
mit Feder
Spring clip
connecting link



Nr. 111 (S)
Verbindungsglied
mit Splinten
Connecting link
with cotted pin



Nr. 12 (L)
Gekröpftes Glied
mit Splint
Single cranked link



Nr. 15 (C)
Gekröpftes
Doppelglied
Double cranked link

Einfach-Rollenketten nach Werksnorm Simplex roller chains (Works-standard)



Teilung	Werksnorm	Innere Breite	Rollen-Ø	Kette	Verbindungsglieder		
<i>Pitch</i>	<i>Works-Standard</i>	<i>Inner width</i>	<i>Roller Ø</i>	<i>Chain</i>	<i>Connecting links</i>		
p mm	Nr. No.	b ₁ mm	d ₁ mm	€/m	€/Stück piece Nr. No. 11	€/Stück piece Nr. No. 111	€/Stück piece Nr. No. 12
9,525 9,525	453 454	3,3 3,94	6 6,38	auf Anfrage on request			
12,7 12,7	332 385	4,88 6,4	7,75 7,75				
12,7 12,7 12,7	18 460 461	4,88 5,21 6,4	7,75 8,51 8,51				
15,875 19,05 19,05	500 515 517	6,48 13,5 11,68	10,16 12,07 12,07				
25,4 25,4 25,4	540 546 b 547	12,7 12,7 12,7	12,7 14 15,88				
30 35	552 577	17,02 19,6	15,88 19,05				

Langgliedrige Rollenketten nach DIN 8181 Double pitch roller chains according to DIN 8181

DIN/ISO	Werksnorm	Teilung	Kette	Verbindungsglieder		
DIN/ISO	<i>Works-Standard</i>	<i>Pitch</i>	<i>Chain</i>	<i>Connecting links</i>		
Nr. No.	Nr. No.	p mm	€/m	€/Stück piece Nr. 11	€/Stück piece Nr. 111	€/Stück piece Nr. 12
208B 210B 212B	713 717 722	25,4 31,75 38,1	auf Anfrage on request			
216B 220B	728 734	50,8 63,5				

* gekröpftes Doppelglied Nr. 15 double cranked link No. 15

Rollenketten mit geraden Laschen

Roller chains with single hole bent attacheme



Teilung	Werksnorm	Innere Breite	Rollen-Ø	Kette	Verbindungsglieder		
<i>Pitch</i>	<i>Works-Standard</i>	<i>Inner width</i>	<i>Roller Ø</i>	<i>Chain</i>	<i>Connecting links</i>		
p mm	Nr. No.	b ₁ mm	d ₁ mm	€/m	€/Stück piece Nr. No. 11	€/Stück piece Nr. No. 111	€/Stück piece Nr. No. 12
9,525 12,7	455 462 GL	5,72 7,75	6,35 8,51	auf Anfrage on request	auf Anfrage on request		
15,875 19,05 25,4	501 GL 513 GL 548 GLS	9,65 11,68 17,02	10,16 12,07 15,88				
25,4 31,75 38,1	548 GL 563 GL 596 GL	17,02 19,56 25,4	15,88 19,05 25,4				
9,525 12,7	D 455 D 462 GL	5,72 7,75	6,35 8,51				
15,875 19,05 25,4	D 501 GL D 513 GL D 548 GLS	9,65 11,68 17,02	10,16 12,07 15,88				
25,4 31,75 38,1	D 548 GL D 563 GL D 596 GL	17,02 19,56 25,4	15,88 19,05 25,4				
9,525 12,7 15,875	T 455 T 462 GL T 501 GL	5,72 7,75 9,65	6,35 8,51 10,16				
19,05 25,4 25,4	T 513 GL T 548 GLS T 548 GL	11,68 17,02 17,02	12,07 15,88 15,88				
19,05 19,05	60 GL 60 HGL	12,57 12,57	11,91 11,91				
41,5	6144	20,7	15,9				

80

* 3-Glieder-Stücke, bestehend aus: Nr. 11, 12 und 4
3-link-pieces, composed of Nr. 11, 12 and 14

Rollenketten nach DIN 8187-1 – Marathon, wartungsfrei

Roller chains to DIN 8187-1 – Marathon, maintenance-free



Kette		Teilung		Innere Breite	Innengliedbreite	Breite zw. AL	Rollen-Ø	Bolzen-Ø	Quer- teilung	La- schen- höhe	Über- stand	Maß über Bolzen	Ge- lenk- fläche	Bruch- kraft	Ge- wicht	Ver- bindungs- glieder	Kette
Chain		Pitch		Inner width	Inner link width	Outer plate width	Roller Ø	Pin Ø	Trans- verse pitch	Plate height	Projec- tion over connec- ting link	Width over pin	Bearing area	Minimum tensile strength	Weight	Connecting links	Chain
⚙		P		b ₁ min.	b ₂ max.	b ₃ min.	d ₁ max.	d ₂ max.	e	g max.	k max.	l max.	f	F _B min.	q ≈		
Nr. No.	Ind.	mm	inch	mm	mm	mm	mm	mm	mm	mm	mm	mm	cm ²	kN	kg/m	Nr. No.	€/m
06 B-1 MA	¹	9,525	³ / ₈	5,72	8,53	8,66	6,35	3,28	–	8,2	3,3	13,5	0,28	9,6	0,41	11,12	auf Anfrage on request
08 B-1 MA		12,7	¹ / ₂	7,75	11,30	11,43	8,51	4,45	–	11,8	3,9	17,0	0,50	18,6	0,70	11,12	
10 B-1 MA		15,875	⁵ / ₈	9,65	13,28	13,41	10,16	5,08	–	14,7	4,1	19,6	0,67	27,0	0,91	11,12	
12 B-1 MA		19,05	³ / ₄	11,68	15,62	15,75	12,07	5,72	–	16,1	4,6	22,7	0,89	31,0	1,18	11,12	
16 B-1 MA		25,4	1	17,02	25,40	25,60	15,83	8,28	–	21,0	5,4	36,1	2,10	72,0	2,68	11,111,12	
552 MA		30,0	–	17,02	25,40	–	15,88	8,28	–	21,0	5,4	36,1	2,10	72,0	2,50	11,111,12	
20 B-1 MA		31,75	1 ¹ / ₄	19,56	29,00	29,20	19,05	10,19	–	26,4	6,1	43,2	2,96	105,0	3,50	111,12	
24 B-1 MA		38,1	1 ¹ / ₂	25,40	37,90	38,20	25,40	14,63	–	33,4	6,6	53,4	5,54	180,0	6,80	111,12	
06 B-2 MA	¹	9,525	³ / ₈	5,72	8,53	8,66	6,35	3,28	10,24	8,2	3,3	23,8	0,56	17,4	0,78	11,12	
08 B-2 MA		12,7	¹ / ₂	7,75	11,30	11,43	8,51	4,45	13,92	11,8	3,9	31,0	1,01	37,0	1,36	11,12	
10 B-2 MA		15,875	⁵ / ₈	9,65	13,28	13,41	10,16	5,08	16,59	14,7	4,1	36,2	1,34	54,0	1,82	11,12	
12 B-2 MA		19,05	³ / ₄	11,68	15,62	15,75	12,07	5,72	19,46	18,1	4,6	42,2	1,79	63,0	2,38	11,12	
16 B-2 MA		25,4	1	17,02	25,40	25,60	15,88	8,28	31,88	21,0	5,4	68,0	4,21	140,0	5,30	11,111,12	
20 B-2 MA		31,75	1 ¹ / ₄	19,56	25,40	29,20	19,05	10,19	36,45	26,4	6,1	79,0	5,91	210,0	7,30	111,12	
24 B-2 MA		38,1	1 ¹ / ₂	25,40	37,90	38,20	25,40	14,63	48,36	33,4	6,6	101,0	11,09	360,0	13,40	111,12	
06 B-3 MA	¹	9,525	³ / ₈	5,72	8,53	8,66	6,35	3,28	10,24	8,2	3,3	34,0	0,81	24,9	1,18	11,12	
08 B-3 MA		12,7	¹ / ₂	7,75	11,30	11,43	8,51	4,45	13,92	11,8	3,9	44,9	1,51	56,0	2,01	11,12	
10 B-3 MA		15,875	⁵ / ₈	9,65	13,28	13,41	10,16	5,08	15,59	14,7	4,1	52,8	2,02	80,0	2,70	11,12	
12 B-3 MA		19,05	³ / ₄	11,68	15,62	15,75	12,07	5,72	19,46	16,1	4,6	61,7	2,68	94,0	3,12	11,12	
16 B-3 MA		25,4	1	17,02	25,40	25,60	15,88	8,28	31,88	21,0	5,4	99,9	6,31	211,0	7,50	11,111,12	
20 B-3 MA		31,75	1 ¹ / ₄	19,56	29,00	29,20	19,05	10,19	36,45	26,4	6,1	116,0	8,87	300,0	10,60	111,12	
24 B-3 MA		38,1	1 ¹ / ₂	25,40	37,90	38,20	25,40	14,63	48,36	33,4	6,6	150,0	16,63	523,0	20,00	111,12	

DIN	Teilung		Verbindungsglieder Marathon, wartungsfrei		
	Pitch		connecting links Marathon, maintenance-free		
	P		Nr. No. 11	Nr. No. 111	Nr. No. 12
Nr. No.	mm	inch			
06 B-1 MA	9,525	³ / ₈			
08 B-1 MA	12,7	¹ / ₂			
10 B-1 MA	15,875	⁵ / ₈			
12 B-1 MA	19,05	³ / ₄			
16 B-1 MA	25,4	1			
552 MA	30,0	–			
20 B-1 MA	31,75	1 ¹ / ₄			
24 B-1 MA	38,1	1 ¹ / ₂			
06 B-2 MA	9,525	³ / ₈			
08 B-2 MA	12,7	¹ / ₂			
10 B-2 MA	15,875	⁵ / ₈			
12 B-2 MA	19,05	³ / ₄			
16 B-2 MA	25,4	1			
20 B-2 MA	31,75	1 ¹ / ₄			
24 B-2 MA	38,1	1 ¹ / ₂			
06 B-3 MA	9,525	³ / ₈			
08 B-3 MA	12,7	¹ / ₂			
10 B-3 MA	15,875	⁵ / ₈			
12 B-3 MA	19,05	³ / ₄			
16 B-3 MA	25,4	1			
20 B-3 MA	31,75	1 ¹ / ₄			
24 B-3 MA	38,1	1 ¹ / ₂			

auf
Anfrage
on
request

Verbindungsglieder:
Bezeichnung nach DIN
Connecting links:
description according to DIN



Nr. 11 (E)
Verbindungsglied
mit Feder
Spring clip
connecting link



Nr. 12 (L)
Gekröpftes Glied
mit Splint
Single cranked link



Nr. 111 (S)
Verbindungsglied
mit Splinten
Connecting link
with cottered pin

Diese Preise gelten pro Stück. These prices are valid for one piece only.

Buchsenketten nach DIN 8164 Bush chains according to DIN 8164



Teilung	Werksnorm	Innere Breite	Rollen-Ø	Kette	Verbindungsglieder		
<i>Pitch</i>	<i>Works-Standard</i>	<i>Inner width</i>	<i>Roller Ø</i>	<i>Chain</i>	<i>Connecting links</i>		
p mm	Nr. No.	b ₁ mm	d ₁ mm	€/m	€/Stück piece Nr. No. 11	€/Stück piece Nr. No. 111	€/Stück piece Nr. No. 12
15	200	14	9	auf Anfrage on request	auf Anfrage on request		
20	203	16	12				
25	206	18	15				
30	209	20	17				
35	212	22	18				
40	215	25	20				
45	218	30	22				
50	221	35	26				
55	222	45	30				
60	223	50	32				
65	224	55	36				
70	225	65	42				

82

Hohlbolzenketten Hollow pin chains

Teilung	Werksnorm	Innere Breite	Rollen- (Buchsen-) Ø	Kette	Nietglied
<i>Pitch</i>	<i>Works-Standard</i>	<i>Inner width</i>	<i>Roller (Bushing) Ø</i>	<i>Chains</i>	<i>Riveted link</i>
p mm	Nr. No.	b ₁ mm	d ₁ mm	€/m	Nr. 7 €/Stück piece
12,7	01105	3,3	7,75	auf Anfrage on request	auf Anfrage on request
12,7	01462	7,75	8,51		
12,7	01463	9,5	8,51		
15,875	01500	6,5	10,16		
15,875	01501	9,5	10,16		
19,05	01513	11,7	12,07		
38,1	01589	15,2	18		
50	01597	15	26		
50	01598	15	26		
50,8	01650	10	30		
50,8	01650 K *	10	30		
50,8	01650 V *	10	30		
50,8	01650 KV *	10	30		
50,8	01650 RF *	10	30		
50,8	01650 RFK*	10	30		

* RF = aus rost- und säurebeständigem Stahl, Werkstoff 1.4301
made of stainless and acid resistant steel, W.-No. 1.4301

K = Kunststoffrolle Plastic rollers V = verzinkt galvanised

Einfach- u. Mehrfach-Rollenketten aus rost- u. säurebeständigem Stahl, Werkstoff 1.4301



Simplex and multiplex roller chains made of stainless and acid resistant steel, W.-no. 1.4301

Teilung	Werksnorm	Innere Breite	Rollen-Ø	Kette	Verbindungsglieder		
Pitch	Works-Standard	Inner width	Roller Ø	Chain	Connecting links		
p mm	Nr. No.	b ₁ mm	d ₁ mm	€/m	€/Stück piece Nr. No. 11	€/Stück piece Nr. No. 111	€/Stück piece Nr. No. 12
8 9,525	450 RF 35 RF	3 4,68	5 5,08	auf Anfrage on request			
12,7 12,7 12,7 12,7	331 RF 332 RF 40 RF 462 RF	3,3 4,88 7,85 7,75	7,75 7,75 7,95 8,51				
15,875 19,05 19,05	501 RF 513 RF 60 RF	9,65 11,68 12,57	10,16 12,07 11,91				
25,4 25,4	548 RF 713 RF	17,02 7,75	15,88 8,51				
31,75 38,1 50,8	717 RF 722 RF 728 RF	9,65 11,68 17,02	10,16 12,07 15,88				
8 12,7 15,875	D 450 RF D 462 RF D 501 RF	3 7,75 9,65	5 8,51 10,16				
19,05 19,05 25,4	D 513 RF 60-2 RF D 548 RF	11,68 12,57 17,02	12,07 11,91 15,88				
12,7 15,875	T 462 RF T 501 RF	7,75 9,65	8,51 10,16				
19,05 19,05 25,4	T 513 RF 60-3 RF T 548 RF	11,68 12,57 17,02	12,07 11,91 15,88				

* mit angesetztem Nietbolzen
with attached rivetted pin

** gekröpftes Doppelglied Nr. 15
double cranked link No. 15

**Einfach- u. Mehrfach-Rollenketten m. geraden Laschen
aus rost- u. säurebeständigem Stahl, Werkstoff 1.4301**

***Simplex and multiplex roller chains made of stainless
and acid resistant steel, W.-no. 1.4301 straight plates***



WIPPERMANN

Teilung	Werksnorm	Innere Breite	Rollen-Ø	Kette	Verbindungsglieder		
<i>Pitch</i>	<i>Works-Standard</i>	<i>Inner width</i>	<i>Roller Ø</i>	<i>Chain</i>	<i>Connecting links</i>		
p mm	Nr. No.	b ₁ mm	d ₁ mm	€/m	€/Stück piece Nr. No. 11	€/Stück piece Nr. No. 111	€/Stück piece Nr. No. 12
9,525 12,7 15,875	455 RF 462 RFG 501 RFG	5,72 7,75 9,65	6,35 8,51 10,16	auf Anfrage on request		auf Anfrage on request	
19,05 25,4 25,4	513 RFG 548 RFGS 548 RFG	11,68 17,02 17,02	12,07 15,88 15,88				
9,525 12,7 15,875	D 455 RF D 462 RFG D 501 RFG	5,72 7,75 9,65	6,35 8,51 10,16				
19,05 25,4 25,4	D 513 RFG D 548 RFGS D 548 RFG	11,68 17,02 17,02	12,07 15,88 15,88				
9,525 12,7 15,875	T 455 RF T 462 RFG T 501 RFG	5,72 7,75 9,65	6,35 8,51 10,16				
19,05 25,4 25,4	T 513 RFG T 548 RFGS T 548 RFG	11,68 17,02 17,02	12,07 15,88 15,88				

* mit angesetztem Nietbolzen
with attached rivetted pin

** gekröpftes Doppelglied Nr. 15
double cranked link No. 15

*** 3-Glieder-Stück, bestehend aus: Nr. 11, 12 und 4
3-link-pieces, composed of Nr. 11, 12 and 14

Verbindungsglieder für Rollenketten nach DIN 8187-1 (europäische Bauart) entsprechend ISO 606



Connecting links for roller chains acc. to DIN 8187-1 (European type) corresponding to ISO 606

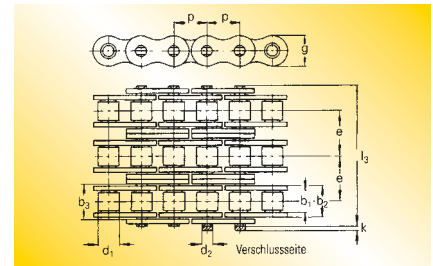
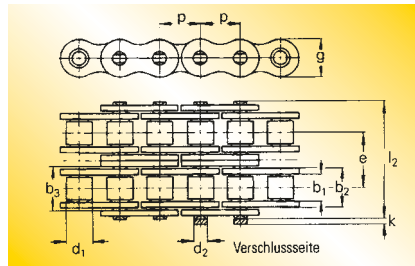
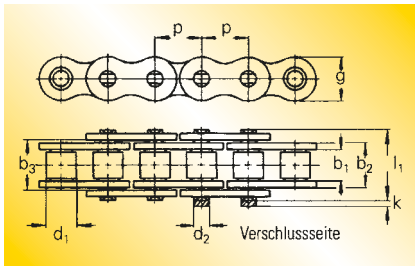

	Teilung		Preis
	Pitch		Price
DIN	P		
Nr. No.	mm	inch	€/Stück piece
05 B-1 E	8,0	—	auf Anfrage on request
05 B-1 C	8,0	—	
06 B-1 E	9,525	3/8	
06 B-1 L	9,525	3/8	
08 B-1 E	12,7	1/2	
08 B-1 L	12,7	1/2	
10 B-1 E	15,875	5/8	
10 B-1 L	15,875	5/8	
12 B-1 E	19,05	3/4	
12 B-1 L	19,05	3/4	
16 B-1 E	25,4	1	
16 B-1 L	25,4	1	
16 B-1 S	25,4	1	
20 B-1 E	31,75	1 1/4	
20 B-1 L	31,75	1 1/4	
20 B-1 S	31,75	1 1/4	
24 B-1 L	38,1	1 1/2	
24 B-1 S	38,1	1 1/2	
28 B-1 S	44,45	1 3/4	
28 B-1 L	44,45	1 3/4	
32 B-1 S	50,8	2	
32 B-1 L	50,8	2	
40 B-1 S	63,5	2 1/2	
40 B-1 L	63,5	2 1/2	
48 B-1 S	76,2	3	
48 B-1 L	76,2	3	

	Teilung		Preis
	Pitch		Price
DIN	P		
Nr. No.	mm	inch	€/Stück piece
05 B-2 E	8,0	—	auf Anfrage on request
05 B-2 C	8,0	—	
06 B-2 E	9,525	3/8	
06 B-2 L	9,525	3/8	
08 B-2 E	12,7	1/2	
08 B-2 L	12,7	1/2	
10 B-2 E	15,875	5/8	
10 B-2 L	15,875	5/8	
12 B-2 E	19,05	3/4	
12 B-2 L	19,05	3/4	
16 B-2 E	25,4	1	
16 B-2 L	25,4	1	
16 B-2 S	25,4	1	
20 B-2 E	31,75	1 1/4	
20 B-2 L	31,75	1 1/4	
20 B-2 S	31,75	1 1/4	
24 B-2 L	38,1	1 1/2	
24 B-2 S	38,1	1 1/2	
28 B-2 S	44,45	1 3/4	
28 B-2 L	44,45	1 3/4	
32 B-2 S	50,8	2	
32 B-2 L	50,8	2	
40 B-2 S	63,5	2 1/2	
40 B-2 L	63,5	2 1/2	
48 B-2 S	76,2	3	
48 B-2 L	76,2	3	

	Teilung		Preis
	Pitch		Price
DIN	P		
Nr. No.	mm	inch	€/Stück piece
05 B-3 E	8,0	—	auf Anfrage on request
05 B-3 C	8,0	—	
06 B-3 E	9,525	3/8	
06 B-3 L	9,525	3/8	
08 B-3 E	12,7	1/2	
08 B-3 L	12,7	1/2	
10 B-3 E	15,875	5/8	
10 B-3 L	15,875	5/8	
12 B-3 E	19,05	3/4	
12 B-3 L	19,05	3/4	
16 B-3 E	25,4	1	
16 B-3 L	25,4	1	
16 B-3 S	25,4	1	
20 B-3 E	31,75	1 1/4	
20 B-3 L	31,75	1 1/4	
20 B-3 S	31,75	1 1/4	
24 B-3 L	38,1	1 1/2	
24 B-3 S	38,1	1 1/2	
28 B-3 S	44,45	1 3/4	
28 B-3 L	44,45	1 3/4	
32 B-3 S	50,8	2	
32 B-3 L	50,8	2	
40 B-3 S	63,5	2 1/2	
40 B-3 L	63,5	2 1/2	
48 B-3 S	76,2	3	
48 B-3 L	76,2	3	

Verbindungsglieder: Bezeichnung nach DIN

Connecting links: description according to DIN



Nr. 4 (B)
Innenglied
Inner link



Nr. 7 (A)
Außenglied
(Nietglied)
Outer link
(to be rivetted)



Nr. 11 (E)
Verbindungsglied
mit Feder+
Spring clip
connecting link



Nr. 111 (S)
Verbindungsglied
mit Splinten
Connecting link
with cottered pin



Nr. 12 (L)
Gekröpftes Glied
mit Splint
Single cranked link



Nr. 15 (C)
Gekröpftes
Doppelglied
Double cranked link

Flyerketten – Reihe LL nach DIN 8152
Leaf chains type series LL according to DIN 8152



Teilung	Werksnorm	Laschenkombination	Kette	Endglied
<i>Pitch</i>	<i>Works-Standard</i>	<i>Lacing</i>	<i>Chain</i>	<i>End link</i>
p mm	Nr. No.		€/m	€/Stück piece
12,7 12,7 12,7	F 122 F 124 F 126	2 x 2 4 x 4 6 x 6	auf Anfrage on request	auf Anfrage on request
15,875 15,875 15,875	F 152 F 154 F 156	2 x 2 4 x 4 6 x 6		
19,05 19,05 19,05	F 192 F 194 F 196	2 x 2 4 x 4 6 x 6		
25,4 25,4 25,4	F 252 F 254 F 256	2 x 2 4 x 4 6 x 6		
31,75 31,75 31,75	F 312 F 314 F 316	2 x 2 4 x 4 6 x 6		
38,1 38,1 38,1	F 382 F 384 F 386	2 x 2 4 x 4 6 x 6		
50,8 50,8 50,8	F 502 F 504 F 506	2 x 2 4 x 4 6 x 6		
50,8 50,8	F 508 F 501	8 x 8 10 x 10		

Flyerketten – schwere Reihe U nach Werksnorm Leaf chains heavy duty design U to works-standard



WIPPERMANN

Teilung	Werksnorm	Laschenkombination	Kette	Endglied
<i>Pitch</i>	<i>Works-Standard</i>	<i>Lacing</i>	<i>Chain</i>	<i>End link</i>
p mm	Nr. No.		€/m	€/Stück piece
38,1	F 384 U	4 x 4	auf Anfrage on request	auf Anfrage on request
38,1	F 386 U	6 x 6		
38,1	F 388 U	8 x 8		
50,8	F 504 U	4 x 4		
50,8	F 506 U	6 x 6		
50,8	F 508 U	8 x 8		
50,8	F 501 U	10 x 10		
63,5	F 634 U	4 x 4		
63,5	F 636 U	6 x 6		
63,5	F 638 U	8 x 8		

87

Buchsen-Zahnketten mit Außenführung (60°-Flankenwinkel)

Inverted tooth chains with bushings (60° flank angle)

Teilung	Werksnorm	Kette	Verbindungsbolzen	Verbindungsglieder	Verbindungsglieder
<i>Pitch</i>	<i>Works-Standard</i>	<i>Chain</i>	<i>Connecting pin</i>	<i>Connecting links</i>	<i>Connecting links</i>
p mm	Nr. No.	€/m	€/Stück piece Nr. No. 10	€/Stück piece Nr. No. 52	€/Stück piece Nr. No. 53
10	1110	auf Anfrage on request		auf Anfrage on request	
10	1112				
10	1114				
10	1115				

Bolzenlöser Chain breaker



Werksnorm	Passend für die Ketten	Bolzenlöser	Ersatzbolzen
<i>Works-Standard</i>	<i>Suitable for the following chains</i>	<i>Chain breaker</i>	<i>Replacement pin</i>
Nr. No.		€/Stück piece	€/Stück piece
KT 455	454, 455, 331, 332, D455, ASA 35, 40, 41, 35-2, 40-2	auf Anfrage on request	auf Anfrage on request
KT 462	331, 332, 17, 18, 385, 460, 461, 462, D462, ASA 35, 40, 41, 40-2		
KT 501-513	500, 501, 513, D501, D513, ASA 50, 60, 50-2		
KT 548	548, ASA 80		

88

Montagespanner Chain puller

Werksnorm	Passend für	
<i>Works-Standard</i>	<i>Suitable for</i>	
Nr. No.		€/Stück piece
135	Rollenketten nach DIN und weitere Gelenkketten <i>Roller chains according to DIN and other sprocket chains</i> Teilung <i>Pitch</i> p: 9,525 mm (3/8") bis 19,05 mm (3/4") (max. 20 mm)	auf Anfrage on request
180	Rollenketten nach DIN und weitere Gelenkketten <i>Roller chains according to DIN and other sprocket chains</i> Teilung <i>Pitch</i> p: 25,4 mm (1") bis to 63,5 mm (2 1/2") (max. 65 mm)	

Ketten-Type		Feder-/ Splintverschlussglied	Gekröpftes Glied
<i>Chain type</i>		<i>Spring clip/ cottered pin connecting link</i>	<i>Cranked link</i>
	€/m	€/Stück piece	€/Stück piece
Einfach-Rollenketten nach DIN		Simplex roller chains according to DIN	
04-B1		auf Anfrage on request	
05-B1			
06-B1			
08-B1			
10-B1			
12-B1			
16-B1			
20-B1			
24-B1			
28-B1			
32-B1			
40-B1			
48-B1			
Zweifach-Rollenketten nach DIN		Duplex roller chains according to DIN	
05-B2		auf Anfrage on request	
06-B2			
08-B2			
10-B2			
12-B2			
16-B2			
20-B2			
24-B2			
28-B2			
32-B2			
40-B2			
48-B2			
Dreifach-Rollenketten nach DIN		Triplex roller chains according to DIN	
06-B3		auf Anfrage on request	
08-B3			
10-B3			
12-B3			
16-B3			
20-B3			
24-B3			
28-B3			
32-B3			
40-B3			
48-B3			

Ketten-Type		Feder-/ Splintverschlussglied	Gekröpftes Glied
Chain type		Spring clip/ cottered pin connecting link	Cranked link
	€/m	€/Stück piece	€/Stück piece
Einfach-Rollenketten mit geraden Laschen	Simplex roller chains with straight side plates		
08-B1 GL	auf Anfrage on request		
10-B1 GL			
12-B1 GL			
16-B1 GL, g = 21 mm			
16-B1 GL, g = 24 mm			
20-B1 GL			
24-B1 GL			
32-B1 GL			
Zweifach-Rollenketten mit geraden Laschen	Duplex roller chains with straight side plates		
08-B2 GL	auf Anfrage on request		
10-B2 GL			
12-B2 GL			
16-B2 GL, g = 21 mm			
20-B2 GL			
24-B2 GL			
Einfach-ASA-Ketten	Simplex ASA chains		
40 08-A1	auf Anfrage on request		
50 10-A1			
60 12-A1			
80 16-A1			
100 20-A1			
120 24-A1			
140 28-A1			
160 32-A1			
Zweifach-ASA-Ketten	Duplex ASA chains		
40 08-A2	auf Anfrage on request		
50 10-A2			
60 12-A2			
80 16-A2			
100 20-A2			
120 24-A2			
140 28-A2			
160 32-A2			
ASA-Ketten mit geraden Laschen	ASA chains with straight side plates		
60-GL 12-A1 GL	auf Anfrage on request		
80-GL 16-A1 GL			

Ketten-Type		Feder-/ Splintverschlussglied	Gekröpftes Glied
Chain type		Spring clip/ cottered pin connecting link	Cranked link
	€/m	€/Stück piece	€/Stück piece
Einfach-ASA-Ketten verstärkt	Simplex ASA chains, reinforced		
60-H 12-A1	auf Anfrage on request		
80-H 16-A1			
100-H 20-A1			
120-H 24-A1			
140-H 28-A1			
Zweifach-ASA-Ketten verstärkt	Duplex ASA chains, reinforced		
60-H 12-A2	auf Anfrage on request		
80-H 16-A2			
100-H 20-A2			
120-H 24-A2			
140-H 28-A2			
ASA-Ketten verstärkt, mit geraden Laschen	ASA chains, reinforced, with straight side plates		
60-HGL 12-A1	auf Anfrage on request		
80-HGL 16-A1			

Rollenketten – Reihe SS „rostfrei“ Roller chains SS series „stainless steel“

Ketten-Type		Gerades Verbindungsglied	Gekröpftes Verbindungsglied
Chain type		Straight connecting link	Cranked connecting link
	€/m	€/Stück piece	€/Stück piece
06 B-1 SS, 3/8" 06 B-2 SS, 3/8"	auf Anfrage on request		
08 B-1 SS, 1/2" 08 B-2 SS, 1/2"			
10 B-1 SS, 5/8" 10 B-2 SS, 5/8"			
12 B-1 SS, 3/4" 12 B-2 SS, 3/4"			
16 B-1 SS, 1" 16 B-2 SS, 1"			

Rollenketten – Reihe SS, mit geraden Laschen Roller chains SS series with straight side plates



Ketten-Type			
Chain type			
	€/m	€/Stück piece	€/Stück piece
C 08 B-1 SS	auf Anfrage on request		
C 10 B-1 SS			
C 12 B-1 SS			
C 16 B-1 SS			

Flyerketten – Serie F/LL nach DIN 8152 Leaf chains F/LL series according to DIN 8152

92

Ketten-Type	Teilung	Laschenkombination		Verbindungsbolzen
Chain type	Pitch	Lacing		Connecting pin
	mm		€/m	€/Stück piece
F 122 - LL0822 F 124 - LL0844 F 126 - LL0866	1/2" = 12,7 1/2" = 12,7 1/2" = 12,7	2 x 2 4 x 4 6 x 6	auf Anfrage on request	
F 152 - LL1022 F 154 - LL1044 F 156 - LL1066	5/8" = 15,875 5/8" = 15,875 5/8" = 15,875	2 x 2 4 x 4 6 x 6		
F192 - LL1222 F194 - LL1244 F196 - LL1266	3/4" = 19,05 3/4" = 19,05 3/4" = 19,05	2 x 2 4 x 4 6 x 6		
F252 - LL1622 F254 - LL1644 F256 - LL1666	1" = 25,4 1" = 25,4 1" = 25,4	2 x 2 4 x 4 6 x 6		
F312 - LL2022 F314 - LL2044 F316 - LL2066	1 1/4" = 31,75 1 1/4" = 31,75 1 1/4" = 31,75	2 x 2 4 x 4 6 x 6		
F382 - LL2422 F384 - LL2444 F386 - LL2466	1 1/2" = 38,1 1 1/2" = 38,1 1 1/2" = 38,1	2 x 2 4 x 4 6 x 6		

Flyerketten – Serie BL/LH nach DIN 8152 Leaf chains BL/LH series according to DIN 8152

Ketten-Type	Teilung	Laschenkombination		Verbindungsbolzen
Chain type	Pitch	Lacing		Connecting pin
	mm		€/m	€/Stück piece
BL523 - LH1023	5/8" = 15,875	2 x 3	auf Anfrage on request	
BL534 - LH1034	5/8" = 15,875	3 x 4		
BL544 - LH1044	5/8" = 15,875	4 x 4		
BL546 - LH1046	5/8" = 15,875	4 x 6		
BL566 - LH1066	5/8" = 15,875	6 x 6		
BL623 - LH1223	3/4" = 19,05	2 x 3		
BL634 - LH1234	3/4" = 19,05	3 x 4		
BL644 - LH1244	3/4" = 19,05	4 x 4		
BL646 - LH1246	3/4" = 19,05	4 x 6		
BL666 - LH1266	3/4" = 19,05	6 x 6		
BL823 - LH1623	1" = 25,4	2 x 3		
BL834 - LH1634	1" = 25,4	3 x 4		
BL844 - LH1644	1" = 25,4	4 x 4		
BL846 - LH1646	1" = 25,4	4 x 6		
BL866 - LH1666	1" = 25,4	6 x 6		

Vernickelte Witra-Rollenketten nach DIN 8187
Nickel plated roller chains according to DIN 8187



	Preis bis	Preis über	Federverbindungsglied	Gekröpftes Glied
	<i>Price to</i>	<i>Price over</i>	<i>Spring clip connecting link</i>	<i>Cranked connecting link</i>
	100 m	100 m	Nr. No. 11	Nr. No. 12
06B-1 3/8 x 7/32" vernickelt <i>nickel plated</i>	auf Anfrage on request			
08B-1 1/2 x 5/16" vernickelt <i>nickel plated</i>				
08B-2 1/2 x 5/16" vernickelt <i>nickel plated</i>				
10B-1 5/8 x 3/8" vernickelt <i>nickel plated</i>				
10B-2 5/8 x 3/8" vernickelt <i>nickel plated</i>				
12B-1 3/4 x 7/16" vernickelt <i>nickel plated</i>				
12B-2 3/4 x 7/16" vernickelt <i>nickel plated</i>				
16B-1 1 x 17,02 mm vernickelt <i>nickel plated</i>				

Kettenräder Sprockets

Kettenräder mit einseitiger Nabe für Simplex-, Duplex- und Triplex-Rollenkette nach DIN 8187 - ISO/R 606
Sprockets for simplex, duplex and triplex chain according to DIN 8187 - ISO/R 606

06B

Kette chain	mm	Kettenräder sprockets	mm
Teilung Pitch	9,525	Radius Tooth radius	r 10
Innere Breite Internal width	5,72	Breite radius width	c 1
Rollen Roller	∅ 6,35	Zahnbreite Tooth width	h ₁ 5,3
		Zahnbreite Tooth width	L 5,2
		Zahnbreite Tooth width	h ₂ 15,4
		Zahnbreite Tooth width	h ₃ 25,6
		Gesamthöhe Full height	H —

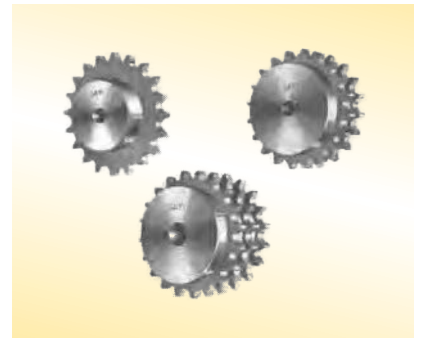

Material C 45 E - UNI EN 10083-1

3/8" x 7/32"

9,525 x 5,72 mm

Z	De	Dp	SIMPLEX			DUPLEX			TRIPLEX			Z	De	Dp	SIMPLEX			DUPLEX			TRIPLEX		
			d	D	H	d	D	H	d	D	H				d	D	H	d	D	H	d	D	H
8	28,0	24,89	15	8	22	15	6	22	15	6	32	25	80,0	76,00	57	12	28	64	12	30	64	14	40
9	31,0	27,85	18	8	22	18	8	22	18	8	32	26	83,0	79,02	60	12	28	67	12	30	67	14	40
10	34,0	30,82	20	8	22	20	8	22	20	10	32	27	86,0	82,04	60	12	28	70	12	30	70	14	40
11	37,0	33,80	22	8	25	22	10	25	22	10	35	28	89,0	85,07	60	12	28	73	12	30	73	14	40
12	40,0	36,80	25	8	25	25	10	25	25	10	35	29	92,0	88,09	60	12	28	76	12	30	76	14	40
13	43,0	39,80	28	10	25	28	10	25	28	10	35	30	94,7	91,12	60	12	30	79	12	30	79	14	40
14	46,3	42,80	31	10	25	31	10	25	31	12	35	31	98,3	94,15	65	14	30	80	16	30	80	16	40
15	49,3	45,81	34	10	25	34	10	25	34	12	35	32	101,3	97,17	65	14	30	80	16	30	80	16	40
16	52,3	48,82	37	10	28	37	12	30	37	12	35	33	104,3	100,20	65	14	30	80	16	30	80	16	40
17	55,3	51,83	40	10	28	40	12	30	40	12	35	34	107,3	103,23	65	14	30	80	16	30	85	16	40
18	58,3	54,85	43	10	28	43	12	30	43	12	35	35	110,4	106,26	65	14	30	80	16	30	85	16	40
19	61,3	57,87	45	10	28	46	12	30	46	12	35	36	113,4	109,29	70	16	30	90	16	30	90	16	40
20	64,3	60,89	46	10	28	49	12	30	49	12	35	37	116,4	112,32	70	16	30	90	16	30	90	16	40
21	68,0	63,91	48	12	28	52	12	30	52	14	40	38	119,5	115,34	70	16	30	90	16	30	90	16	40
22	71,0	66,93	50	12	28	55	12	30	55	14	40	39	122,5	118,37	70	16	30	90	16	30	90	16	40
23	73,5	69,95	52	12	28	58	12	30	58	14	40	40	125,5	121,40	70	16	30	90	16	30	90	16	40
24	77,0	72,97	54	12	28	61	12	30	61	14	40												

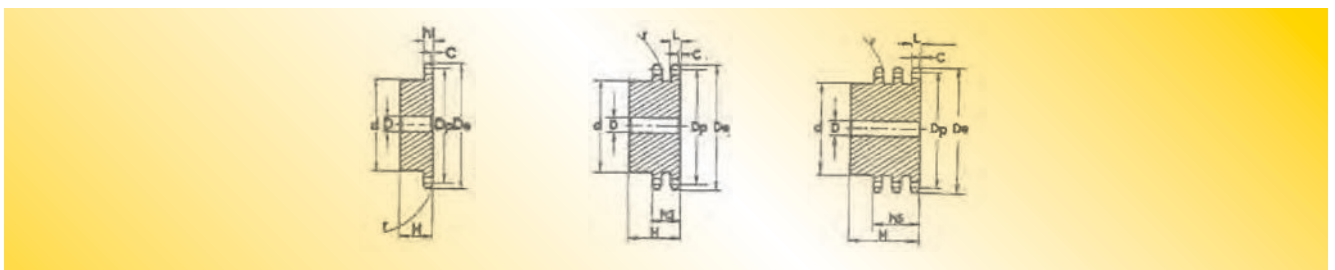

Kettenräder Sprockets

Kettenräder mit einseitiger Nabe für Simplex-, Duplex- und Triplex-Rollenkette nach DIN 8187 - ISO/R 606
Sprockets for simplex, duplex and triplex chain according to DIN 8187 - ISO/R 606

08B

Kette chain	mm	Kettenräder sprockets	mm
Teilung Pitch	12,70	Radius Tooth radius	r 13
Innere Breite Internal width	7,75	Breite radius width	c 1,3
Rollen Roller \varnothing	8,51	Zahnbreite Tooth width	h_1 7,2
		Zahnbreite Tooth width	L 7
		Zahnbreite Tooth width	h_2 21
		Zahnbreite Tooth width	h_3 34,9
		Gesamthöhe Full height	H —

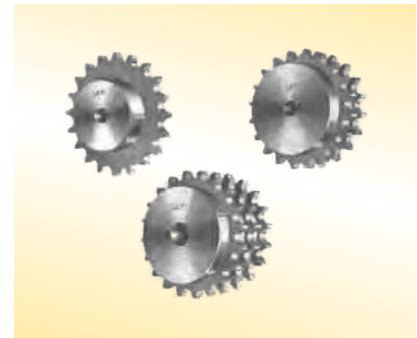

Material C 45 E - UNI EN 10083-1

1/2" x 5/16"

12,7 x 7,75 mm

Z	De	Dp	SIMPLEX			DUPLEX			TRIPLEX			Z	De	Dp	SIMPLEX			DUPLEX			TRIPLEX		
			d	D	H	d	D	H	d	D	H				d	D	H	d	D	H	d	D	H
8	37,2	33,18	20	10	25	20	10	32	20	10	46	25	105,8	101,33	70	14	28	80	16	40	80	20	55
9	41,0	37,13	24	10	25	24	10	32	24	12	46	26	110,0	105,36	70	16	30	85	20	40	85	20	55
10	45,2	41,10	26	10	25	28	10	32	28	12	46	27	114,0	109,40	70	16	30	85	20	40	85	20	55
11	48,7	45,07	29	10	25	32	12	35	32	14	50	28	118,0	113,42	70	16	30	90	20	40	90	20	55
12	53,0	49,07	33	10	28	35	12	35	35	14	50	29	122,0	117,46	80	16	30	95	20	40	95	20	55
13	57,4	53,06	37	10	28	38	12	35	38	14	50	30	126,1	121,50	80	16	30	100	20	40	100	20	55
14	61,8	57,07	41	10	28	42	12	35	42	14	50	31	130,2	125,54	90	16	30	100	20	40	110	20	55
15	65,5	61,09	45	10	28	46	12	35	46	14	50	32	134,3	129,56	90	16	30	100	20	40	110	20	55
16	69,5	65,10	50	12	28	50	14	35	50	16	50	33	138,4	133,60	90	16	30	100	20	40	110	20	55
17	73,6	69,11	52	12	28	54	14	35	54	16	50	34	142,6	137,64	90	16	30	100	20	40	110	20	55
18	77,8	73,14	56	12	28	58	14	35	58	16	50	35	146,7	141,68	90	16	30	100	20	40	110	20	55
19	81,7	77,16	60	12	28	62	14	35	62	16	50	36	151,0	145,72	90	16	35	110	20	40	120	25	55
20	85,8	81,19	64	12	28	66	14	35	66	16	50	37	154,6	149,76	90	16	35	110	20	40	120	25	55
21	89,7	85,22	68	12	28	70	16	40	70	20	55	38	158,6	153,80	90	16	35	110	20	40	120	25	55
22	93,8	89,24	70	12	28	70	16	40	70	20	55	39	162,7	157,83	90	16	35	110	20	40	120	25	55
23	98,2	93,27	70	14	28	70	16	40	70	20	55	40	166,8	161,87	90	16	35	110	20	40	120	25	55
24	101,8	97,29	70	14	28	75	16	40	75	20	55												

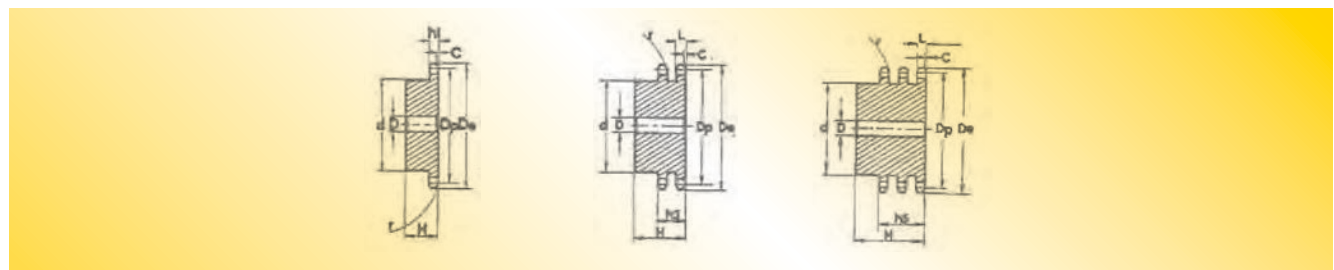

Lagerverfügbarkeit der Kettenräder von Z=41 bis Z=125 ist zu prüfen. Availability of sprockets from Z=41 to Z=125 can be checked on demand.

Kettenräder Sprockets

Kettenräder mit einseitiger Nabe für Simplex-, Duplex- und Triplex-Rollenkette nach DIN 8187 - ISO/R 606
Sprockets for simplex, duplex and triplex chain according to DIN 8187 - ISO/R 606

10B

Kette chain	mm	Kettenräder sprockets	mm
Teilung Pitch	15,875	Radius Tooth radius	r 16
Innere Breite Internal width	9,65	Breite radius width	c 1,6
Rollen Roller	∅ 10,16	Zahnbreite Tooth width	h ₁ 9,1
		Zahnbreite Tooth width	L 9
		Zahnbreite Tooth width	h ₂ 25,5
		Zahnbreite Tooth width	h ₃ 42,1
		Gesamthöhe Full height	H —



Material C 45 E - UNI EN 10083-1

5/8" x 3/8"

15,875 x 9,65 mm

Z	De	Dp	SIMPLEX			DUPLEX			TRIPLEX			Z	De	Dp	SIMPLEX			DUPLEX			TRIPLEX		
			d	D	H	d	D	H	d	D	H				d	D	H	d	D	H	d	D	H
8	47,0	41,48	25	10	25	25	12	40	25	12	55	25	134,0	126,66	80	16	30	105	16	45	105	20	60
9	52,6	46,42	30	10	25	30	12	40	30	12	55	26	139,0	131,70	85	20	35	110	20	45	110	20	60
10	57,5	51,37	35	10	25	35	12	40	35	16	55	27	144,0	136,75	85	20	35	110	20	45	110	20	60
11	63,0	56,34	37	12	30	39	14	40	39	16	55	28	148,7	141,78	90	20	35	115	20	45	115	20	60
12	68,0	61,34	42	12	30	44	14	40	44	16	55	29	153,8	146,83	90	20	35	115	20	45	115	20	60
13	73,0	66,32	47	12	30	49	14	40	49	16	55	30	158,8	151,87	90	20	35	120	20	45	120	20	60
14	78,0	71,34	52	12	30	54	14	40	54	16	55	31	163,9	156,92	95	20	35	120	20	45	120	20	60
15	83,0	76,36	57	12	30	59	14	40	59	16	55	32	168,9	161,95	95	20	35	120	20	45	120	20	60
16	88,0	81,37	60	12	30	64	16	45	64	16	60	33	174,5	167,00	95	20	35	120	20	45	120	20	60
17	93,0	86,39	60	12	30	69	16	45	69	16	60	34	179,0	172,05	95	20	35	120	20	45	120	20	60
18	98,3	91,42	70	14	30	74	16	45	74	16	60	35	184,1	177,10	95	20	35	120	20	45	120	20	60
19	103,3	96,45	70	14	30	79	16	45	79	16	60	36	189,1	182,15	100	20	35	120	20	45	120	25	60
20	108,4	101,49	75	14	30	84	16	45	84	16	60	37	194,2	187,20	100	20	35	120	20	45	120	25	60
21	113,4	106,52	75	16	30	85	16	45	85	20	60	38	199,2	192,24	100	20	35	120	20	45	120	25	60
22	118,0	111,55	80	16	30	90	16	45	90	20	60	39	204,2	197,29	100	20	35	120	20	45	120	25	60
23	123,4	116,58	80	16	30	95	16	45	95	20	60	40	209,3	202,34	100	20	35	120	20	45	120	25	60
24	128,3	121,62	80	16	30	100	16	45	100	20	60												

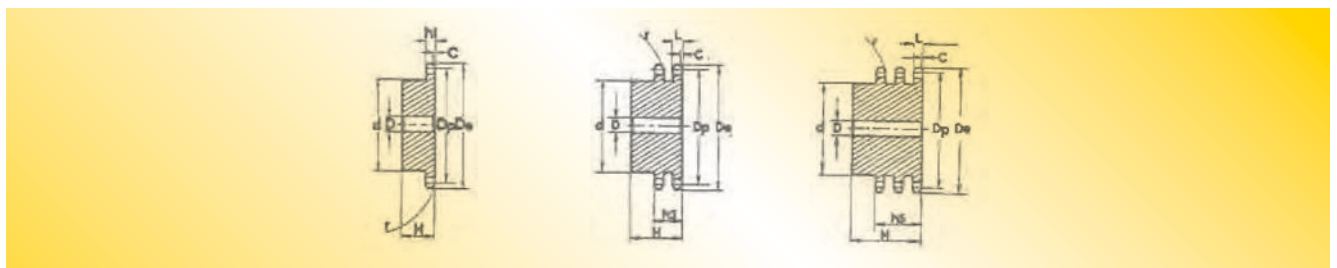

Kettenräder Sprockets

Kettenräder mit einseitiger Nabe für Simplex-, Duplex- und Triplex-Rollenkette nach DIN 8187 - ISO/R 606
Sprockets for simplex, duplex and triplex chain according to DIN 8187 - ISO/R 606

12B

Kette chain	mm	Kettenräder sprockets	mm
Teilung Pitch	19,05	Radius Tooth radius	r 19
Innere Breite Internal width	11,68	Breite radius width	c 2
Rollen Roller \varnothing	12,07	Zahnbreite Tooth width	h_1 11,1
		Zahnbreite Tooth width	L 10,8
		Zahnbreite Tooth width	h_2 30,3
		Zahnbreite Tooth width	h_3 49,8
		Gesamthöhe Full height	H —

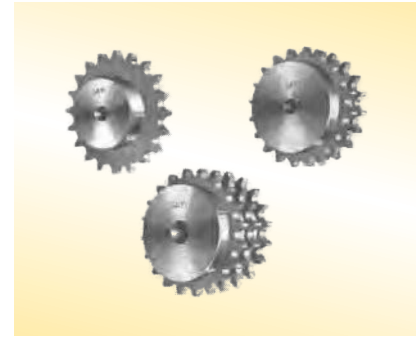

Material C 45 E - UNI EN 10083-1

3/4" x 7/16"

19,05 x 11,68 mm

Z	De	Dp	SIMPLEX			DUPLEX			TRIPLEX			Z	De	Dp	SIMPLEX			DUPLEX			TRIPLEX		
			d	D	H	d	D	H	d	D	H				d	D	H	d	D	H	d	D	H
8	57,6	49,78	31	12	30	31	12	45	31	16	65	25	160,0	152,00	90	20	40	120	20	50	120	20	70
9	62,0	55,70	37	12	30	37	12	45	37	16	65	26	165,9	158,04	95	20	40	120	20	50	120	20	70
10	69,0	61,64	42	12	30	42	12	45	42	16	65	27	172,3	164,09	95	20	40	120	20	50	120	20	70
11	75,0	67,61	46	14	35	47	16	50	47	20	70	28	178,0	170,13	95	20	40	120	20	50	120	20	70
12	81,5	73,60	52	14	35	53	16	50	53	20	70	29	184,1	176,19	95	20	40	120	20	50	120	20	70
13	87,5	79,59	58	14	35	59	16	50	59	20	70	30	190,5	182,25	95	20	40	120	20	50	120	20	70
14	93,6	85,61	64	14	35	65	16	50	65	20	70	31	196,3	188,31	100	20	40	130	20	50	130	25	70
15	99,8	91,63	70	14	35	71	16	50	71	20	70	32	203,3	194,35	100	20	40	130	20	50	130	25	70
16	105,5	97,65	75	16	35	77	20	50	77	20	70	33	209,3	200,40	100	20	40	130	20	50	130	25	70
17	111,5	103,67	80	16	35	83	20	50	83	20	70	34	214,6	206,46	100	20	40	130	20	50	130	25	70
18	118,0	109,71	80	16	35	89	20	50	89	20	70	35	221,0	212,52	100	20	40	130	20	50	130	25	70
19	124,2	115,75	80	16	35	95	20	50	95	20	70	36	226,8	218,58	100	20	40	130	25	50	130	25	70
20	129,7	121,78	80	16	35	100	20	50	100	20	70	37	232,9	224,64	100	20	40	130	25	50	130	25	70
21	136,0	127,82	90	20	40	100	20	50	100	20	70	38	239,0	230,69	100	20	40	130	25	50	130	25	70
22	141,8	133,86	90	20	40	100	20	50	100	20	70	39	245,1	236,75	100	20	40	130	25	50	130	25	70
23	149,0	139,90	90	20	40	110	20	50	110	20	70	40	251,3	242,81	100	20	40	130	25	50	130	25	70
24	153,9	145,94	90	20	40	110	20	50	110	20	70												

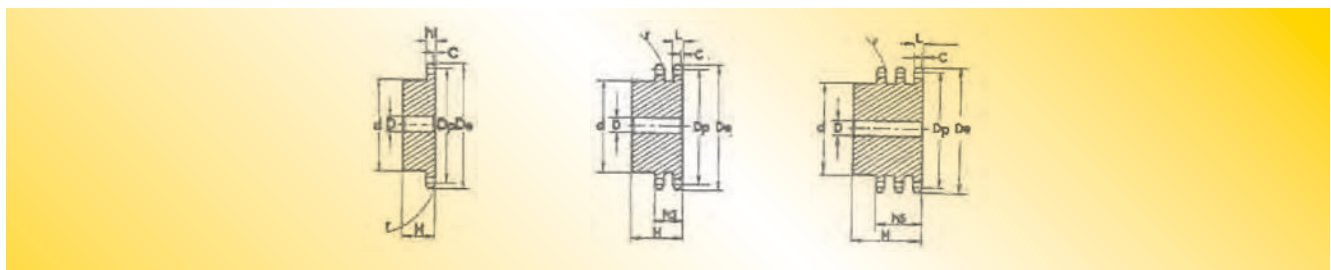

Lagerverfügbarkeit der Kettenräder von Z=41 bis Z=125 ist zu prüfen. Availability of sprockets from Z=41 to Z=125 can be checked on demand.

Kettenräder Sprockets

Kettenräder mit einseitiger Nabe für Simplex-, Duplex- und Triplex-Rollenkette nach DIN 8187 - ISO/R 606
Sprockets for simplex, duplex and triplex chain according to DIN 8187 - ISO/R 606

16B

Kette chain	mm	Kettenräder sprockets	mm
Teilung Pitch	25,4	Radius Tooth radius	r 26
Innere Breite Internal width	17,02	Breite radius width	c 2,5
Rollen Roller	∅ 15,88	Zahnbreite Tooth width	h ₁ 16,2
		Zahnbreite Tooth width	L 15,8
		Zahnbreite Tooth width	h ₂ 47,7
		Zahnbreite Tooth width	h ₃ 79,6
		Gesamthöhe Full height	H —

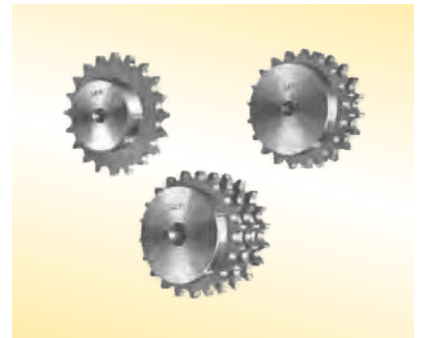

Material C 45 E - UNI EN 10083-1

* Typen mit eingeschweisster Nabe, Fe 50
Types with welded hub, Fe 50

1" x 17,02 mm

25,4 x 17,02 mm

Z	De	Dp	SIMPLEX			DUPLEX			TRIPLEX			Z	De	Dp	SIMPLEX			DUPLEX			TRIPLEX		
			d	D	H	d	D	H	d	D	H				d	D	H	d	D	H	d	D	H
8	77,0	66,37	42	16	35	42	16	65	42	20	95	25	213,5	202,66	110	20	50	*130	25	70	*130	30	100
9	85,0	74,27	50	16	35	50	16	65	50	20	95	26	221,6	210,72	120	20	50	*130	25	70	*130	30	100
10	93,0	82,19	55	16	35	56	16	65	56	20	95	27	229,6	218,79	120	20	50	*130	25	70	*130	30	100
11	99,5	90,14	61	16	40	64	20	70	64	25	100	28	237,7	226,85	120	20	50	*130	25	70	*130	30	100
12	109,0	98,14	69	16	40	72	20	70	72	25	100	29	245,8	234,92	120	20	50	*130	25	70	*130	30	100
13	117,0	106,12	78	16	40	80	20	70	80	25	100	30	254,0	243,00	120	20	50	*130	25	70	*130	30	100
14	125,0	114,15	84	16	40	88	20	70	88	25	100	31	262,0	251,08	*120	25	50	*140	25	70	*140	30	100
15	133,0	122,17	92	16	40	96	20	70	96	25	100	32	270,0	259,13	*120	25	50	*140	25	70	*140	30	100
16	141,0	130,20	100	20	45	104	20	70	104	30	100	33	278,5	267,21	*120	25	50	*140	25	70	*140	30	100
17	149,0	138,22	100	20	45	112	20	70	112	30	100	34	287,0	275,28	*120	25	50	*140	25	70	*140	30	100
18	157,0	146,28	100	20	45	120	20	70	120	30	100	35	296,2	283,36	*120	25	50	*140	25	70	*140	30	100
19	165,2	154,33	100	20	45	128	20	70	128	30	100	36	304,6	291,44	*120	25	50	*140	25	70	*140	30	100
20	173,2	162,38	100	20	45	130	20	70	130	30	100	37	312,6	299,51	*120	25	50	*140	25	70	*140	30	100
21	181,2	170,43	110	20	50	130	25	70	*130	30	100	38	320,7	307,59	*120	25	50	*140	25	70	*140	30	100
22	189,3	178,48	110	20	50	*130	25	70	*130	30	100	39	328,8	315,67	*120	25	50	*140	25	70	*140	30	100
23	197,5	186,53	110	20	50	*130	25	70	*130	30	100	40	336,9	323,73	*120	25	50	*140	25	70	*140	30	100
24	205,5	194,59	110	20	50	*130	25	70	*130	30	100												

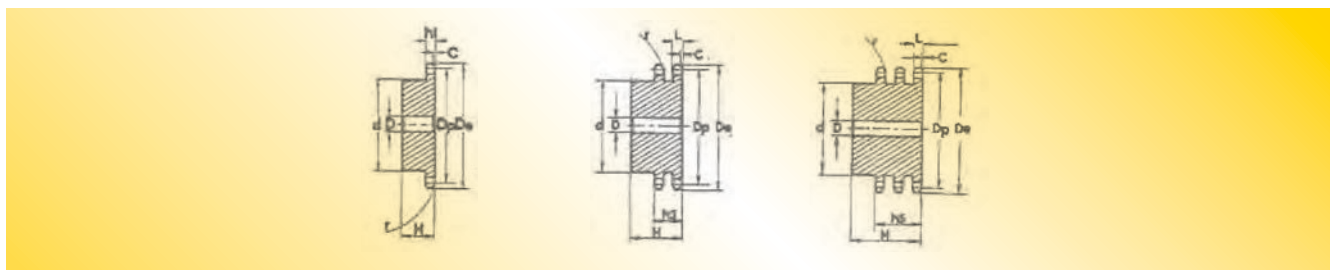

Kettenräder Sprockets

Kettenräder mit einseitiger Nabe für Simplex-, Duplex- und Triplex-Rollenkette nach DIN 8187 - ISO/R 606
Sprockets for simplex, duplex and triplex chain according to DIN 8187 - ISO/R 606

20B

Kette chain	mm	Kettenräder sprockets	mm
Teilung Pitch	31,75	Radius Tooth radius	r 32
Innere Breite Internal width	19,56	Breite radius width	c 3,5
Rollen Roller \varnothing	19,05	Zahnbreite Tooth width	h_1 18,5
		Zahnbreite Tooth width	L 18,2
		Zahnbreite Tooth width	h_2 54,6
		Zahnbreite Tooth width	h_3 91
		Gesamthöhe Full height	H —

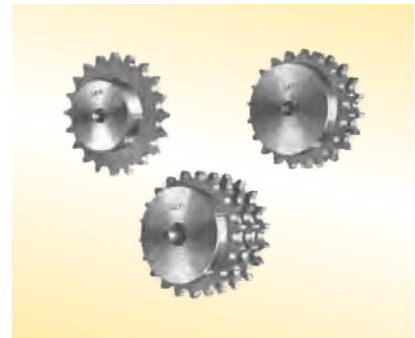

Material C 45 E - UNI EN 10083-1

* Typen mit eingeschweisster Nabe, Fe 50
Types with welded hub, Fe 50

1"1/4 x 3/4

31,75 x 19,56 mm

Z	De	Dp	SIMPLEX			DUPLEX			TRIPLEX			Z	De	Dp	SIMPLEX			DUPLEX			TRIPLEX		
			d	D	H	d	D	H	d	D	H				d	D	H	d	D	H	d	D	H
8	98,1	82,96	53	20	40	53	20	75	53	20	110	25	268,5	253,33	140	25	55	*140	25	80	*140	25	115
9	108,0	92,84	63	20	40	63	20	75	63	20	110	26	278,6	263,40	*150	25	55	*150	25	80	*150	25	115
10	117,9	102,74	70	20	40	70	20	75	70	20	110	27	288,6	273,48	*150	25	55	*150	25	80	*150	25	115
11	127,8	112,68	77	20	45	80	20	80	80	20	115	28	298,7	283,56	*150	25	55	*150	25	80	*150	25	115
12	137,8	122,68	88	20	45	90	20	80	90	20	115	29	308,8	293,65	*150	25	55	*150	25	80	*150	25	115
13	147,8	132,65	98	20	45	100	20	80	100	20	115	30	318,9	303,75	*150	25	55	*150	25	80	*150	25	115
14	157,8	142,68	108	20	45	110	20	80	110	20	115	31	329,0	313,85	*150	25	55	*150	25	80	*150	30	115
15	167,9	152,72	118	20	45	120	20	80	120	20	115	32	339,1	323,91	*150	25	55	*150	25	80	*150	30	115
16	177,9	162,75	120	25	50	120	25	80	120	25	115	33	349,2	334,01	*150	25	55	*150	25	80	*150	30	115
17	187,9	172,78	120	25	50	120	25	80	120	25	115	34	359,3	334,10	*150	25	55	*150	25	80	*150	30	115
18	198,0	182,85	120	25	50	*120	25	80	*120	25	115	35	369,4	354,20	*150	25	55	*150	25	80	*150	30	115
19	208,1	192,91	120	25	50	*120	25	80	*120	25	115	36	379,5	364,30	*150	25	55	*150	30	80	*150	30	115
20	218,1	202,98	120	25	50	*120	25	80	*120	25	115	37	389,5	374,39	*150	25	55	*150	30	80	*150	30	115
21	228,2	213,04	140	25	55	*140	25	80	*140	25	115	38	399,6	384,49	*150	25	55	*150	30	80	*150	30	115
22	238,3	223,11	140	25	55	*140	25	80	*140	25	115	39	409,7	394,59	*150	25	55	*150	30	80	*150	30	115
23	248,3	233,17	140	25	55	*140	25	80	*140	25	115	40	419,8	404,66	*150	25	55	*150	30	80	*150	30	115
24	258,4	243,23	140	25	55	*140	25	80	*140	25	115												

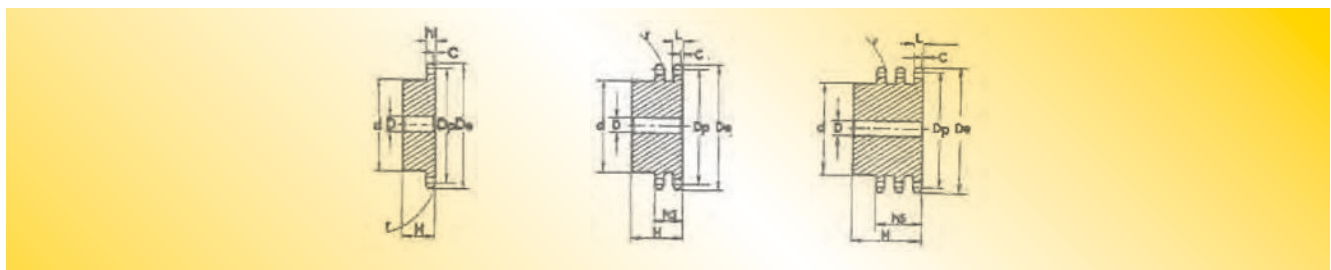

Lagerverfügbarkeit der Kettenräder von Z=41 bis Z=125 ist zu prüfen. Availability of sprockets from Z=41 to Z=125 can be checked on demand.

Kettenräder Sprockets

Kettenräder mit einseitiger Nabe für Simplex-, Duplex- und Triplex-Rollenkette nach DIN 8187 - ISO/R 606
Sprockets for simplex, duplex and triplex chain according to DIN 8187 - ISO/R 606

24B

Kette chain	mm	Kettenräder sprockets	mm
Teilung Pitch	38,1	Radius Tooth radius	r 38
Innere Breite Internal width	25,4	Breite radius width	c 4
Rollen Roller	∅ 25,4	Zahnbreite Tooth width	h ₁ 24,1
		Zahnbreite Tooth width	L 23,6
		Zahnbreite Tooth width	h ₂ 72
		Zahnbreite Tooth width	h ₃ 120,3
		Gesamthöhe Full height	H —

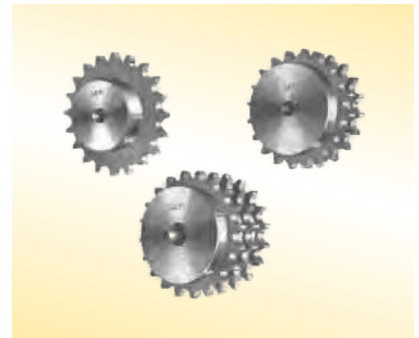

Material C 45 E - UNI EN 10083-1

* Typen mit eingeschweisster Nabe, Fe 50
Types with welded hub, Fe 50

1"1/2 x 1"

38,1 x 25,4 mm

Z	De	Dp	SIMPLEX			DUPLEX			TRIPLEX			Z	De	Dp	SIMPLEX			DUPLEX			TRIPLEX		
			d	D	H	d	D	H	d	D	H				d	D	H	d	D	H	d	D	H
8	115,0	99,55	58	20	45	58	25	95	58	25	140	25	319,0	304,00	*150	25	60	*160	25	100	*160	30	150
9	126,4	111,40	70	20	45	70	25	95	70	25	140	26	331,0	316,08	*160	30	60	*160	30	100	*160	30	150
10	138,0	123,29	80	20	45	80	25	95	80	25	140	27	343,2	328,19	*160	30	60	*160	30	100	*160	30	150
11	150,0	135,21	90	25	50	90	25	100	90	25	150	28	355,2	340,27	*160	30	60	*160	30	100	*160	30	150
12	162,0	147,22	102	25	50	102	25	100	102	25	150	29	367,3	352,38	*160	30	60	*160	30	100	*160	30	150
13	174,2	159,18	114	25	50	114	25	100	114	25	150	30	379,5	364,50	*160	30	60	*160	30	100	*160	30	150
14	186,2	171,22	128	25	50	128	25	100	128	25	150	31	391,6	376,62	*160	30	60	*170	30	100	*170	40	150
15	198,2	183,26	140	25	50	140	25	100	140	25	150	32	403,7	388,69	*160	30	60	*170	30	100	*170	40	150
16	210,3	195,30	*140	25	55	*140	25	100	*140	25	150	33	415,8	400,81	*160	30	60	*170	30	100	*170	40	150
17	222,3	207,34	*140	25	55	*150	25	100	*150	25	150	34	427,8	412,93	*160	30	60	*170	30	100	*170	40	150
18	234,3	219,42	*140	25	55	*160	25	100	*160	25	150	35	440,0	425,04	*160	30	60	*170	30	100	*170	40	150
19	246,5	231,49	*140	25	55	*160	25	100	*160	25	150	36	452,0	437,16	*160	30	60	*170	30	100	*170	40	150
20	258,6	243,57	*140	25	55	*160	25	100	*160	25	150	37	464,2	449,27	*160	30	60	*170	30	100	*170	40	150
21	270,6	255,65	*150	25	60	*160	25	100	*160	30	150	38	476,2	461,39	*160	30	60	*170	30	100	*170	40	150
22	282,7	267,73	*150	25	60	*160	25	100	*160	30	150	39	488,5	473,50	*160	30	60	*170	30	100	*170	40	150
23	294,8	279,80	*150	25	60	*160	25	100	*160	30	150	40	500,6	485,62	*160	30	60	*170	30	100	*170	40	150
24	306,8	291,88	*150	25	60	*160	25	100	*160	30	150												

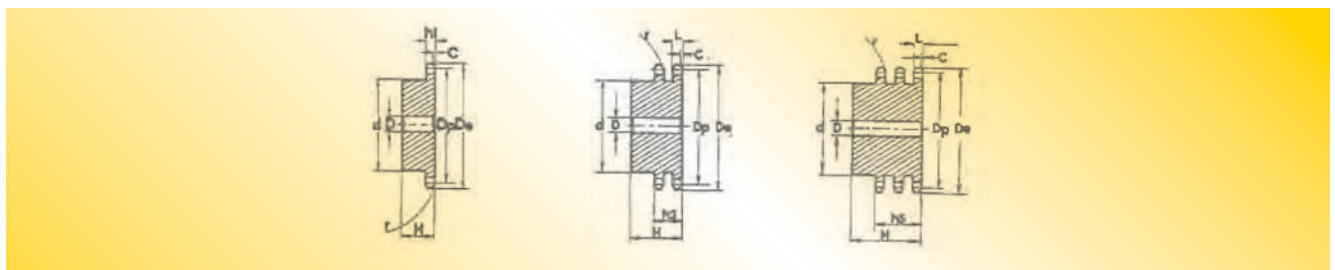

Kettenräder Sprockets

Kettenräder mit einseitiger Nabe für Simplex-, Duplex- und Triplex-Rollenkette nach DIN 8187 - ISO/R 606
Sprockets for simplex, duplex and triplex chain according to DIN 8187 - ISO/R 606

28B

Kette chain	mm	Kettenräder sprockets	mm
Teilung Pitch	44,45	Radius Tooth radius	r 44
Innere Breite Internal width	30,99	Breite radius width	c 5
Rollen Roller \varnothing	27,94	Zahnbreite Tooth width	h_1 29,4
		Zahnbreite Tooth width	L 28,8
		Zahnbreite Tooth width	h_2 88,4
		Zahnbreite Tooth width	h_3 148
		Gesamthöhe Full height	H —

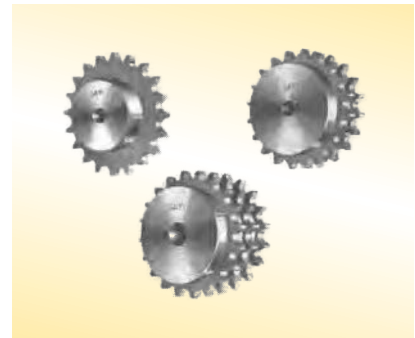

Material C 45 E - UNI EN 10083-1

* Typen mit eingeschweisster Nabe, Fe 50
Types with welded hub, Fe 50

1"3/4 x 1"1/4

44,45 x 30,99 mm

Z	De	Dp	SIMPLEX			DUPLEX			TRIPLEX			Z	De	Dp	SIMPLEX			DUPLEX			TRIPLEX		
			d	D	H	d	D	H	d	D	H				d	D	H	d	D	H	d	D	H
8	132,0	116,15	74	25	70	74	25	120	74	30	180	25	373,0	354,66	*170	30	75	*180	30	120	*180	40	180
9	148,4	129,96	88	25	70	88	25	120	88	30	180	26	387,0	368,77	*170	30	75	*180	30	120	*180	40	180
10	162,3	143,85	100	25	70	100	25	120	100	30	180	27	401,0	382,88	*170	30	75	*180	30	120	*180	40	180
11	176,3	157,77	112	25	70	112	25	120	112	30	180	28	416,0	397,00	*170	30	75	*180	30	120	*180	40	180
12	189,3	171,74	125	25	70	125	25	120	125	30	180	29	430,0	411,12	*170	30	75	*180	30	120	*180	40	180
13	204,2	185,75	*130	25	70	*130	25	120	*130	30	180	30	444,0	425,24	*170	30	75	*180	30	120	*180	40	180
14	218,2	199,76	*130	25	70	*130	25	120	*130	30	180	31	458,0	439,37	*180	30	75	*200	30	120	*200	40	180
15	232,3	213,79	*145	25	70	*145	30	120	*145	30	180	32	472,0	453,49	*180	30	75	*200	30	120	*200	40	180
16	246,3	227,84	*160	30	75	*160	30	120	*160	30	180	33	486,0	467,62	*180	30	75	*200	30	120	*200	40	180
17	260,0	241,90	*160	30	75	*160	30	120	*160	30	180	34	500,0	481,75	*180	30	75	*200	30	120	*200	40	180
18	274,0	255,98	*160	30	75	*160	30	120	*160	30	180	35	514,0	495,88	*180	30	75	*200	30	120	*200	40	180
19	289,0	270,06	*160	30	75	*180	30	120	*180	30	180	36	529,0	510,01	*180	30	75	*200	30	120	*200	40	180
20	303,0	284,15	*160	30	75	*180	30	120	*180	30	180	37	543,0	524,13	*180	30	75	*200	30	120	*200	40	180
21	317,0	298,24	*170	30	75	*180	30	120	*180	30	180	38	557,0	538,27	*180	30	75	*200	30	120	*200	40	180
22	331,0	312,34	*170	30	75	*180	30	120	*180	30	180	39	571,0	552,40	*180	30	75	*200	30	120	*200	40	180
23	345,0	326,44	*170	30	75	*180	30	120	*180	30	180	40	585,0	566,54	*180	30	75	*200	30	120	*200	40	180
24	359,0	340,55	*170	30	75	*180	30	120	*180	30	180												

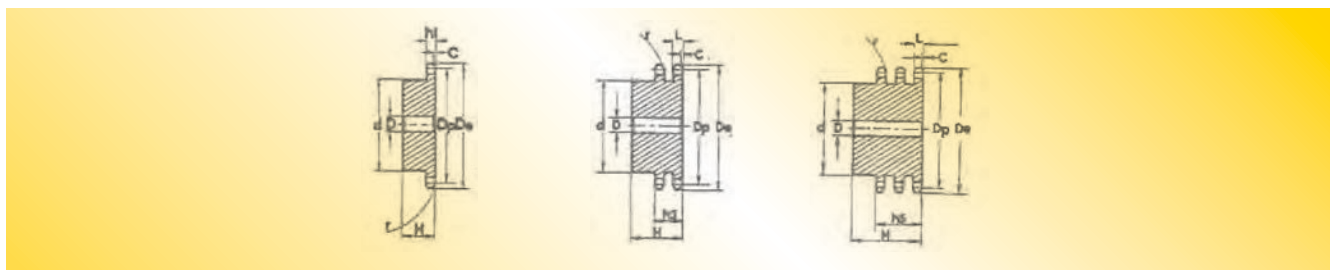

Kettenräder Sprockets

Kettenräder mit einseitiger Nabe für Simplex-, Duplex- und Triplex-Rollenkette nach DIN 8187 - ISO/R 606
Sprockets for simplex, duplex and triplex chain according to DIN 8187 - ISO/R 606

32B

Kette chain	mm	Kettenräder sprockets	mm
Teilung Pitch	50,8	Radius Tooth radius	r 51
Innere Breite Internal width	30,99	Breite radius width	c 6
Rollen Roller \varnothing	29,21	Zahnbreite Tooth width	h_1 29,4
		Zahnbreite Tooth width	L 28,8
		Zahnbreite Tooth width	h_2 87,4
		Zahnbreite Tooth width	h_3 146
		Gesamthöhe Full height	H —

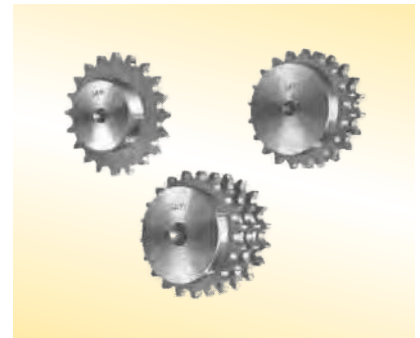

Material C 45 E - UNI EN 10083-1

* Typen mit eingeschweisster Nabe, Fe 50
Types with welded hub, Fe 50

2" x 1"1/4

50,8 x 30,99 mm

Z	De	Dp	SIMPLEX			DUPLEX			TRIPLEX			Z	De	Dp	SIMPLEX			DUPLEX			TRIPLEX		
			d	D	H	d	D	H	d	D	H				d	D	H	d	D	H	d	D	H
8	153,2	132,74	82	25	80	82	30	120	82	30	180	22	377,5	356,98	*180	30	90	*200	30	120	*200	40	180
9	169,0	148,54	88	25	80	88	30	120	88	30	180	23	393,6	373,08	*180	30	90	*200	30	120	*200	40	180
10	185,0	164,39	104	25	80	104	30	120	104	30	180	24	409,7	389,18	*180	30	90	*200	30	120	*200	40	180
11	200,8	180,31	120	30	80	120	30	120	120	30	180	25	425,8	405,33	*180	30	90	*200	30	120	*200	40	180
12	216,8	196,29	*133	30	80	*133	30	120	*133	30	180	26	441,9	421,44	*180	30	90	*200	30	120	*200	40	180
13	232,8	212,29	*145	30	80	*145	30	120	*145	30	180	27	458,1	437,59	*180	30	90	*200	30	120	*200	40	180
14	248,8	228,29	*160	30	80	*160	30	120	*160	30	180	28	474,2	453,69	*180	30	90	*200	30	120	*200	40	180
15	264,8	244,30	*160	30	80	*160	30	120	*160	30	180	29	492,0	469,85	*180	30	90	*200	30	120	*200	40	180
16	280,9	260,40	*160	30	90	*160	30	120	*160	30	180	30	506,5	486,00	*180	30	90	*200	30	120	*200	40	180
17	296,9	276,46	*170	30	90	*170	30	120	*170	30	180	32	538,8	518,27	*180	30	90						
18	313,0	292,55	*170	30	90	*170	30	120	*170	30	180	35	589,5	566,71	*180	30	90						
19	329,1	308,66	*170	30	90	*200	30	120	*200	30	180	38	635,5	615,16	*180	30	90						
20	345,2	324,71	*180	30	90	*200	30	120	*200	30	180	40	670,3	647,47	*180	30	90						
21	361,3	340,82	*180	30	90	*200	30	120	*200	40	180												

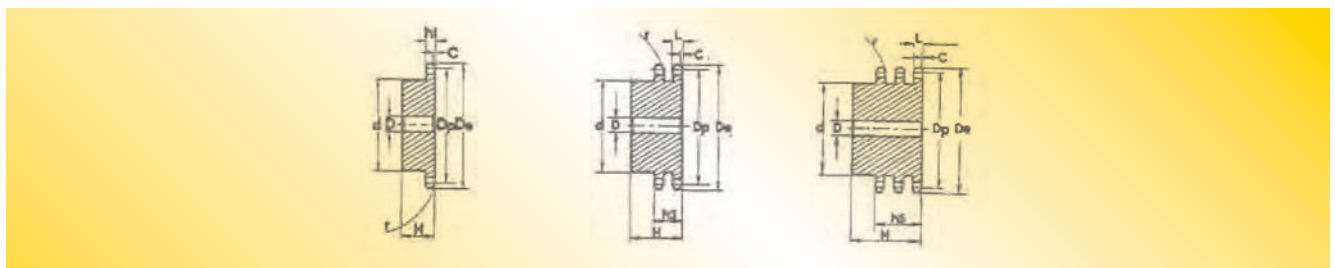

Kettenradscheiben

Plate wheels

Kettenradscheiben für Simplex-, Duplex- und Triplex-Rollenkette nach DIN 8187 - ISO/R 606
 Plate wheels for simplex, duplex and triplex chain according to DIN 8187 - ISO/R 606

06B

Kette chain	mm	Ketteradscheiben plate wheels	mm
Teilung Pitch	9,525	Radius Tooth radius r	10
Innere Breite Internal width	5,72	Breite radius width c	1
		Zahnbreite Tooth width h ₁	5,3
Rollen Roller ø	6,35	Zahnbreite Tooth width L	5,2
		Zahnbreite Tooth width h ₂	15,4
		Zahnbreite Tooth width h ₃	25,6
		Gesamthöhe Full height H	—

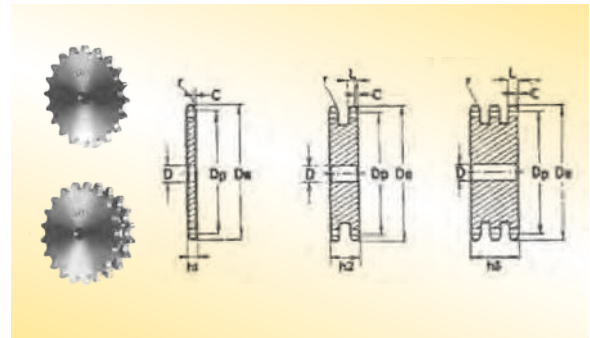

Seitlich plan gedrehte, wälzgefräste Zahnkränze
 Plate wheels turned on both sides and toothed by milling cutter

3/8" x 7/32"

9,525 x 5,72 mm

Z	De	Dp	SIMPLEX D	DUPLEX D	TRIPLEX D	Z	De	Dp	SIMPLEX D	DUPLEX D	TRIPLEX D
8	28,0	24,89	6	6	6	44	137,6	133,52	16	16	16
9	31,0	27,85	7	8	8	45	140,7	136,54	16	16	16
10	34,0	30,82	7	8	10	46	143,7	139,58	16	16	16
11	37,0	33,80	8	10	10	47	146,7	142,61	16	16	16
12	40,0	36,80	8	10	10	48	149,7	145,64	16	16	16
13	43,0	39,80	8	10	10	49	152,7	148,66	16	16	16
14	46,3	42,80	8	10	12	50	155,7	151,69	16	16	16
15	49,3	45,81	8	10	12	51	158,7	154,72	16	16	20
16	52,3	48,82	10	12	12	52	161,8	157,75	16	16	20
17	55,3	51,83	10	12	12	53	164,8	160,78	16	16	20
18	58,3	54,85	10	12	12	54	167,8	163,82	16	16	20
19	61,3	57,87	10	12	12	55	170,8	166,85	16	16	20
20	64,3	60,89	10	12	12	56	173,8	169,88	16	16	20
21	68,0	63,91	10	12	14	57	176,9	172,91	16	16	20
22	71,0	66,93	10	12	14	58	179,9	175,93	16	16	20
23	73,5	69,95	10	12	14	59	183,0	178,96	16	16	20
24	77,0	72,97	10	12	14	60	186,0	181,99	16	16	20
25	80,0	76,00	10	12	14	62	192,1	188,06	20	20	20
26	83,0	79,02	10	12	14	64	198,2	194,12	20	20	20
27	86,0	82,04	10	12	14	65	201,6	197,15	20	20	20
28	89,0	85,07	10	12	14	66	204,6	200,18	20	20	25
29	92,0	88,09	10	12	14	68	210,7	206,24	20	20	25
30	94,7	91,12	10	12	14	70	216,7	212,30	20	20	25
31	98,3	94,15	12	14	16	72	222,8	218,37	20	20	25
32	101,3	97,17	12	14	16	75	231,9	227,46	20	20	25
33	104,3	100,20	12	14	16	76	234,9	230,49	20	20	25
34	107,3	103,23	12	14	16	78	241,0	236,55	20	20	25
35	110,4	106,26	12	14	16	80	247,1	242,61	20	20	25
36	113,4	109,29	12	14	16	85	262,2	257,77	20	20	25
37	116,4	112,32	12	14	16	90	277,4	272,93	20	20	25
38	119,5	115,34	12	14	16	95	292,5	288,08	20	20	25
39	122,5	118,37	12	14	16	100	307,7	303,25	20	20	25
40	125,5	121,40	12	14	16	110	338,0	333,55	20	20	25
41	128,5	124,43	16	16	16	114	349,5	345,68	20	20	25
42	131,6	127,46	16	16	16	120	368,3	363,86	20	20	25
43	134,6	130,49	16	16	16	125	383,5	379,02	20	20	25

Kettenradscheiben Plate wheels

Kettenradscheiben für Simplex-, Duplex- und Triplex-Rollenkette nach DIN 8187 - ISO/R 606
Plate wheels for simplex, duplex and triplex chain according to DIN 8187 - ISO/R 606

08B

Kette chain	mm	Kettenradscheiben plate wheels	mm
Teilung Pitch	12,70	Radius Tooth radius	r 13
Innere Breite Internal width	7,75	Breite radius width	c 1,3
		Zahnbreite Tooth width	h ₁ 7,2
Rollen Roller	ø 8,51	Zahnbreite Tooth width	L 7
		Zahnbreite Tooth width	h ₂ 21
		Zahnbreite Tooth width	h ₃ 34,9
		Gesamthöhe Full height	H —

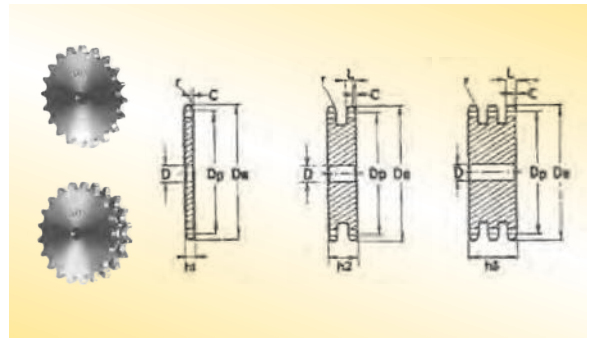

Seitlich plan gedrehte, wälzgefräste Zahnkränze
Plate wheels turned on both sides and toothed by milling cutter

1/2" x 5/16"

12,7 x 7,75 mm

Z	De	Dp	SIMPLEX D	DUPLEX D	TRIPLEX D	Z	De	Dp	SIMPLEX D	DUPLEX D	TRIPLEX D
8	37,2	33,18	8	10	10	44	183,8	178,03	20	20	25
9	41,0	37,13	8	10	10	45	188,0	182,07	20	20	25
10	45,2	41,10	8	10	10	46	192,1	186,10	20	20	25
11	48,7	45,07	10	10	12	47	196,2	190,14	20	20	25
12	53,0	49,07	10	10	12	48	200,3	194,18	20	20	25
13	57,4	53,06	10	10	12	49	204,3	198,22	20	20	25
14	61,8	57,07	10	10	12	50	208,3	202,26	20	20	25
15	65,5	61,09	10	10	12	51	212,1	206,30	20	25	25
16	69,5	65,10	10	12	16	52	216,1	210,34	20	25	25
17	73,6	69,11	10	12	16	53	220,2	214,37	20	25	25
18	77,8	73,14	10	12	16	54	224,1	218,43	20	25	25
19	81,7	77,16	10	12	16	55	228,1	222,46	20	25	25
20	85,8	81,19	10	12	16	56	232,2	226,50	20	25	25
21	89,7	85,22	12	16	16	57	236,4	230,54	20	25	25
22	93,8	89,24	12	16	16	58	240,5	234,58	20	25	25
23	98,2	93,27	12	16	16	59	244,5	238,62	20	25	25
24	101,8	97,29	12	16	16	60	248,6	242,66	20	25	25
25	105,8	101,33	12	16	16	62	256,9	250,75	25	25	25
26	110,0	105,36	16	16	16	64	265,1	258,82	25	25	25
27	114,0	109,40	16	16	16	65	269,0	262,86	25	25	25
28	118,0	113,42	16	16	16	66	273,0	266,90	25	25	25
29	122,0	117,46	16	16	16	68	281,0	274,99	25	25	25
30	126,1	121,50	16	16	16	70	289,0	283,07	25	25	25
31	130,2	125,54	16	16	20	72	297,2	291,16	25	25	25
32	134,3	129,56	16	16	20	75	309,2	303,27	25	25	25
33	138,4	133,60	16	16	20	76	313,3	307,33	25	25	25
34	142,6	137,64	16	16	20	78	321,4	315,40	25	25	25
35	146,7	141,68	16	16	20	80	329,4	323,48	25	25	25
36	151,0	145,72	16	20	20	85	349,0	343,69	25	25	25
37	154,6	149,76	16	20	20	90	369,9	363,90	25	25	25
38	158,6	153,80	16	20	20	95	390,1	384,11	25	25	25
39	162,7	157,83	16	20	20	100	410,3	404,31	25	25	25
40	166,8	161,87	16	20	20	110	450,7	444,74	25	25	25
41	171,4	165,91	20	20	25	114	466,9	460,90	25	25	25
42	175,4	169,95	20	20	25	120	491,2	485,16	25	25	25
43	179,7	173,99	20	20	25	125	511,3	505,37	25	25	25

Kettenradscheiben

Plate wheels

Kettenradscheiben für Simplex-, Duplex- und Triplex-Rollenkette nach DIN 8187 - ISO/R 606
 Plate wheels for simplex, duplex and triplex chain according to DIN 8187 - ISO/R 606

10B

Kette chain	mm	Kettenradscheiben plate wheels	mm
Teilung Pitch	15,875	Radius Tooth radius r	16
Innere Breite Internal width	9,65	Breite radius width c	1,6
		Zahnbreite Tooth width h ₁	9,1
Rollen Roller \varnothing	10,16	Zahnbreite Tooth width L	9
		Zahnbreite Tooth width h ₂	25,5
		Zahnbreite Tooth width h ₃	42,1
		Gesamthöhe Full height H	—

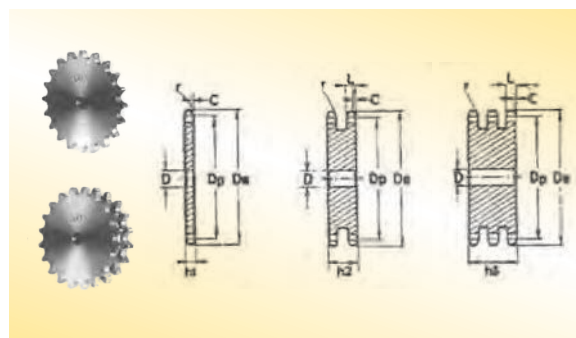

Seitlich plan gedrehte, wälzgefräste Zahnkränze
 Plate wheels turned on both sides and toothed by milling cutter

5/8" x 3/8"

15,875 x 9,65 mm

Z	De	Dp	SIMPLEX D	DUPLEX D	TRIPLEX D	Z	De	Dp	SIMPLEX D	DUPLEX D	TRIPLEX D
8	47,0	41,48	10	10	12	44	230,0	222,53	20	20	25
9	52,6	46,42	10	10	12	45	235,0	227,58	20	20	25
10	57,5	51,37	10	10	12	46	240,1	232,63	20	25	25
11	63,0	56,34	10	12	12	47	245,1	237,68	20	25	25
12	68,0	61,34	10	12	12	48	250,2	242,73	20	25	25
13	73,0	66,32	10	12	12	49	255,2	247,78	20	25	25
14	78,0	71,34	10	12	12	50	260,3	252,82	20	25	25
15	83,0	76,36	10	12	12	51	265,3	257,87	20	25	25
16	88,0	81,37	12	12	16	52	270,4	262,92	20	25	25
17	93,0	86,39	12	12	16	53	275,4	267,97	20	25	25
18	98,3	91,42	12	12	16	54	280,5	273,03	20	25	25
19	103,3	96,45	12	12	16	55	285,5	278,08	20	25	25
20	108,4	101,49	12	12	16	56	290,6	283,13	25	25	25
21	113,4	106,52	12	16	16	57	296,0	288,18	25	25	25
22	118,0	111,55	12	16	16	58	300,7	293,23	25	25	25
23	123,4	116,58	12	16	16	59	305,7	298,27	25	25	25
24	128,3	121,62	12	16	16	60	310,8	303,32	25	25	25
25	134,0	126,66	12	16	16	62	321,4	313,43	25	25	30
26	139,0	131,70	16	16	20	64	331,5	323,53	25	25	30
27	144,0	136,75	16	16	20	65	336,5	328,58	25	25	30
28	148,7	141,78	16	16	20	66	341,6	333,63	25	25	30
29	153,8	146,83	16	16	20	68	351,7	343,74	25	25	30
30	158,8	151,87	16	16	20	70	361,8	353,84	25	25	30
31	163,9	156,92	16	20	20	72	371,9	363,95	25	25	30
32	168,9	161,95	16	20	20	75	387,1	379,09	25	25	30
33	174,5	167,00	16	20	20	76	392,1	384,16	25	25	30
34	179,0	172,05	16	20	20	78	402,2	394,25	25	25	30
35	184,1	177,10	16	20	20	80	412,3	404,35	25	25	30
36	189,1	182,15	20	20	25	85	437,6	429,62	30	30	30
37	194,2	187,20	20	20	25	90	462,8	454,88	30	30	30
38	199,2	192,24	20	20	25	95	488,5	480,14	30	30	30
39	204,2	197,29	20	20	25	100	513,4	505,40	30	30	30
40	209,3	202,34	20	20	25	110	563,9	555,92	30	30	30
41	214,8	207,39	20	20	25	114	584,1	576,13	30	30	30
42	219,9	212,44	20	20	25	120	614,8	606,44	30	30	30
43	224,9	217,49	20	20	25	125	639,7	631,71	30	30	30

Kettenradscheiben Plate wheels

Kettenradscheiben für Simplex-, Duplex- und Triplex-Rollenkette nach DIN 8187 - ISO/R 606
 Plate wheels for simplex, duplex and triplex chain according to DIN 8187 - ISO/R 606

12B

Kette chain	mm	Kettenradscheiben plate wheels	mm
Teilung Pitch	19,05	Radius Tooth radius	r 19
Innere Breite Internal width	11,68	Breite radius width	c 2
		Zahnbreite Tooth width	h ₁ 11,1
Rollen Roller	ø 12,07	Zahnbreite Tooth width	L 10,8
		Zahnbreite Tooth width	h ₂ 30,3
		Zahnbreite Tooth width	h ₃ 49,8
		Gesamthöhe Full height	H —

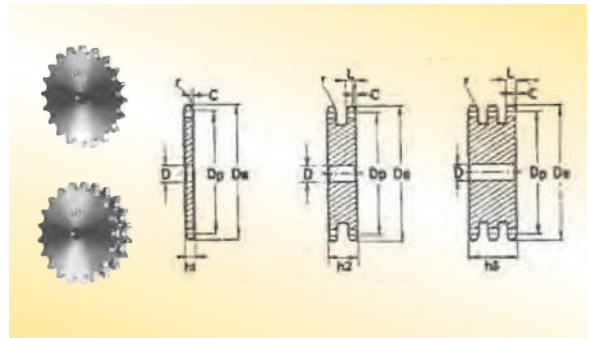

Seitlich plan gedrehte, wälzgefräste Zahnkränze
 Plate wheels turned on both sides and toothed by milling cutter

3/4" x 7/16"

19,05 x 11,68 mm

Z	De	Dp	SIMPLEX D	DUPLEX D	TRIPLEX D	Z	De	Dp	SIMPLEX D	DUPLEX D	TRIPLEX D
8	57,6	49,78	12	12	12	44	276,5	267,03	25	25	25
9	62,0	55,70	12	12	12	45	282,5	273,10	25	25	25
10	69,0	61,64	12	12	12	46	287,9	279,16	25	25	25
11	75,0	67,61	14	14	16	47	294,0	285,21	25	25	25
12	81,5	73,60	14	14	16	48	300,1	291,27	25	25	25
13	87,5	79,59	14	14	16	49	306,2	297,33	25	25	25
14	93,6	85,61	14	14	16	50	312,3	303,39	25	25	25
15	99,8	91,63	14	14	16	51	318,4	309,45	25	25	25
16	105,5	97,65	14	16	16	52	324,5	315,50	25	25	25
17	111,5	103,67	14	16	16	53	330,5	321,56	25	25	25
18	118,0	109,71	14	16	16	54	336,6	327,64	25	25	25
19	124,2	115,75	14	16	16	55	342,7	333,70	25	25	25
20	129,7	121,78	14	16	16	56	348,7	339,75	25	25	30
21	136,0	127,82	16	16	20	57	355,4	345,81	25	25	30
22	141,8	133,86	16	16	20	58	361,5	351,87	25	25	30
23	149,0	139,90	16	16	20	59	367,5	357,93	25	25	30
24	153,9	145,94	16	16	20	60	373,0	363,99	25	25	30
25	160,0	152,00	16	16	20	62	385,1	376,12	25	30	30
26	165,9	158,04	16	20	20	64	397,2	388,24	25	30	30
27	172,3	164,09	16	20	20	65	403,2	394,29	25	30	30
28	178,0	170,13	16	20	20	66	409,2	400,35	30	30	30
29	184,1	176,19	16	20	20	68	421,4	412,49	30	30	30
30	190,5	182,25	16	20	20	70	433,6	424,60	30	30	30
31	196,3	188,31	20	20	25	72	447,0	436,74	30	30	30
32	203,3	194,35	20	20	25	75	463,9	454,91	30	30	30
33	209,3	200,40	20	20	25	76	469,9	460,99	30	30	30
34	214,6	206,46	20	20	25	78	482,1	473,10	30	30	30
35	221,0	212,52	20	20	25	80	494,2	485,22	30	30	30
36	226,8	218,58	20	25	25	85	524,5	515,55	30	30	30
37	232,9	224,64	20	25	25	90	554,8	545,86	30	30	30
38	239,0	230,69	20	25	25	95	585,1	576,17	30	30	30
39	245,1	236,75	20	25	25	100	615,4	606,47	30	30	30
40	251,3	242,81	20	25	25	110	676,1	667,11	30	30	30
41	257,3	248,87	25	25	25	114	700,6	691,36	30	30	30
42	264,5	254,93	25	25	25	120	736,7	727,74	30	30	30
43	270,5	260,98	25	25	25	125	767,0	758,05	30	30	30

Kettenradscheiben

Plate wheels

Kettenradscheiben für Simplex-, Duplex- und Triplex-Rollenkette nach DIN 8187 - ISO/R 606
 Plate wheels for simplex, duplex and triplex chain according to DIN 8187 - ISO/R 606

16B

Kette chain	mm	Ketteradscheiben plate wheels	mm
Teilung Pitch	25,4	Radius Tooth radius	r 26
Innere Breite Internal width	17,02	Breite radius width	c 2,5
		Zahnbreite Tooth width	h ₁ 16,2
Rollen Roller	ø 15,88	Zahnbreite Tooth width	L 15,8
		Zahnbreite Tooth width	h ₂ 47,7
		Zahnbreite Tooth width	h ₃ 79,6
		Gesamthöhe Full height	H —

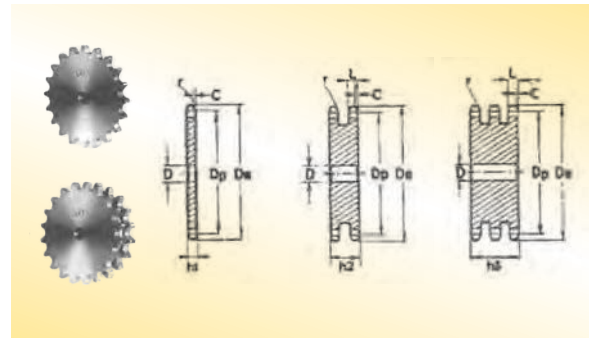

Seitlich plan gedrehte, wälzgefräste Zahnkränze
 Plate wheels turned on both sides and toothed by milling cutter

1" x 17,02 mm

25,4 x 17,02 mm

Z	De	Dp	SIMPLEX D	DUPLEX D	TRIPLEX D	Z	De	Dp	SIMPLEX D	DUPLEX D	TRIPLEX D
8	77,0	66,37	12	16	20	44	369,1	356,06	25	25	30
9	85,0	74,27	12	16	20	45	377,1	364,12	25	25	30
10	93,0	82,19	15	16	20	46	385,2	372,21	25	30	30
11	99,5	90,14	15	20	20	47	393,2	380,29	25		
12	109,0	98,14	15	20	20	48	401,3	388,36	25	30	30
13	117,0	106,12	15	20	20	49	409,3	396,44	25		
14	125,0	114,15	15	20	20	50	417,4	404,52	25	30	30
15	133,0	122,17	15	20	20	51	425,5	412,60	30	30	40
16	141,0	130,20	19	20	30	52	433,6	420,67	30	30	40
17	149,0	138,22	19	20	30	53	441,7	428,75	30		
18	157,0	146,28	19	20	30	54	448,3	436,85	30		
19	165,2	154,33	19	20	30	55	457,9	444,93	30	30	40
20	173,2	162,38	19	20	30	56	466,0	453,01	30	30	
21	181,2	170,43	20	25	30	57	474,0	461,07	30	30	40
22	189,3	178,48	20	25	30	58	482,1	469,16	30		
23	197,5	186,53	20	25	30	59	490,2	477,24	30		
24	205,5	194,59	20	25	30	60	498,3	485,32	30	30	40
25	213,5	202,66	20	25	30	62	514,5	501,50	30	30	
26	221,6	210,72	20	25	30	64	530,7	517,65	30		
27	229,6	218,79	20	25	30	65	538,8	525,73	30	30	40
28	237,7	226,85	20	25	30	66	546,8	533,80	30		
29	245,8	234,92	20	25	30	68	562,9	549,98	30	30	40
30	254,0	243,00	20	25	30	70	579,2	566,14	30	30	40
31	262,0	251,08	25	25	30	72	595,4	582,32	30	30	40
32	270,0	259,13	25	25	30	75	619,7	606,55	30	30	40
33	278,5	267,21	25	25	30	76	627,0	614,65	30	30	40
34	287,0	275,28	25	25	30	78	643,3	630,80	30		
35	296,2	283,36	25	25	30	80	660,0	646,96	30	30	40
36	304,6	291,44	25	25	30	85	699,9	687,40	30	30	40
37	312,6	299,51	25	25	30	90	740,3	727,81	30	30	40
38	320,7	307,59	25	25	30	95	781,1	768,22	30	30	40
39	328,8	315,67	25	25	30	100	821,1	808,63	30	30	40
40	336,9	323,73	25	25	30	110	902,0	889,48	30	30	40
41	345,0	331,82	25			114	934,3	921,81	30	40	40
42	353,0	339,90	25	25	30	120	982,8	970,33	30	40	40
43	361,1	347,98	25	25		125	1023,2	1010,73	30	40	40

Kettenradscheiben Plate wheels

Kettenradscheiben für Simplex-, Duplex- und Triplex-Rollenkette nach DIN 8187 - ISO/R 606
Plate wheels for simplex, duplex and triplex chain according to DIN 8187 - ISO/R 606

20B

Kette chain	mm	Kettenradscheiben plate wheels	mm
Teilung Pitch	31,75	Radius Tooth radius r	32
Innere Breite Internal width	19,56	Breite radius width c	3,5
		Zahnbreite Tooth width h ₁	18,5
Rollen Roller ø	19,05	Zahnbreite Tooth width L	18,2
		Zahnbreite Tooth width h ₂	54,6
		Zahnbreite Tooth width h ₃	91
		Gesamthöhe Full height H	—

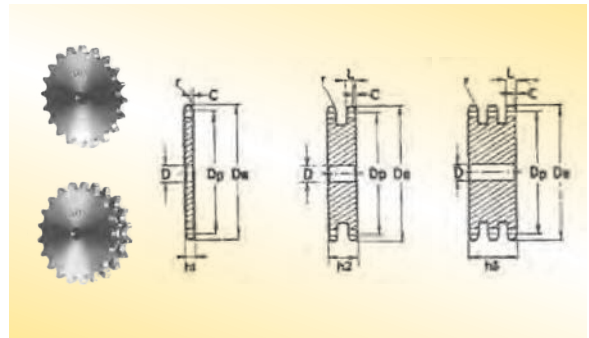

Seitlich plan gedrehte, wälzgefräste Zahnkränze
Plate wheels turned on both sides and toothed by milling cutter

1"1/4 x 3/4

31,75 x 19,56 mm

Z	De	Dp	SIMPLEX D	DUPLEX D	TRIPLEX D	Z	De	Dp	SIMPLEX D	DUPLEX D	TRIPLEX D
8	98,1	82,96	16	20	20	44	460,2	445,07	30		
9	108,0	92,84	16	20	20	45	470,3	455,17	30	30	40
10	117,9	102,74	16	20	20	46	480,4	465,26	30	30	40
11	127,8	112,68	20	20	20	47	490,5	475,36	30		
12	137,8	122,68	20	20	20	48	500,6	485,46	30	30	40
13	147,8	132,65	20	20	20	49	510,7	495,55	30		
14	157,8	142,68	20	20	20	50	520,8	505,65	30	30	40
15	167,9	152,72	20	20	20	51	530,9	515,75	30		
16	177,9	162,75	20	25	25	52	541,0	525,84	30	30	40
17	187,9	172,78	20	25	25	53	551,1	535,94	30		
18	198,0	182,85	20	25	25	54	561,2	546,07	30		
19	208,1	192,91	20	25	25	55	571,3	556,16	30	30	40
20	218,1	202,98	20	25	25	56	581,4	566,26	30		
21	228,2	213,04	25	25	25	57	591,5	576,36	30	30	40
22	238,3	223,11	25	25	25	58	601,6	586,45	30		
23	248,3	233,17	25	25	25	59	611,7	596,55	30		
24	258,4	243,23	25	25	25	60	621,8	606,65	30	30	40
25	268,5	253,33	25	25	25	62	642,0	626,87	30		
26	278,6	263,40	25	25	25	64	662,2	647,06	30		
27	288,6	273,48	25	25	25	65	672,3	657,16	30	30	40
28	298,7	283,56	25	25	25	66	682,4	667,26	30		
29	308,8	293,65	25	25	25	68	702,6	687,48	30		
30	318,9	303,75	25	25	25	70	722,8	707,67	30	30	40
31	329,0	313,85	25	25	30	72	743,1	727,90	30		
32	339,1	323,91	25	25	30	75	773,3	758,19	30		
33	349,2	334,01	25	25	30	76	783,5	768,32	30	30	40
34	359,3	334,10	25	25	30	80	823,9	808,72	30	30	40
35	369,4	354,20	25	25	30	85	874,4	859,25	30		
36	379,5	364,30	25	30	30	90	924,9	909,76	30		
37	389,5	374,39	25	30	30	95	975,2	960,28	30	30	40
38	399,6	384,49	25	30	30	100	1026,0	1010,79	30		
39	409,7	394,59	25	30	30	114	1167,4	1152,26	30	30	40
40	419,8	404,66	25	30	30						
41	429,9	414,78	30								
42	440,0	424,88	30	30	40						
43	450,1	434,97	30								

Kettenradscheiben

Plate wheels

Kettenradscheiben für Simplex-, Duplex- und Triplex-Rollenkette nach DIN 8187 - ISO/R 606
 Plate wheels for simplex, duplex and triplex chain according to DIN 8187 - ISO/R 606

24B

Kette chain	mm	Kettenradscheiben plate wheels	mm
Teilung Pitch	38,1	Radius Tooth radius	r 38
Innere Breite Internal width	25,4	Breite radius width	c 4
Rollen Roller	ø 25,4	Zahnbreite Tooth width	h ₁ 24,1
		Zahnbreite Tooth width	L 23,6
		Zahnbreite Tooth width	h ₂ 72
		Zahnbreite Tooth width	h ₃ 120,3
		Gesamthöhe Full height	H —

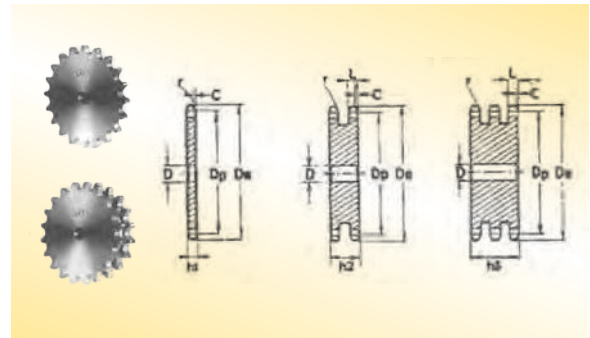

Seitlich plan gedrehte, wälzgefräste Zahnkränze
 Plate wheels turned on both sides and toothed by milling cutter

1"1/2 x 1"

38,1 x 25,4 mm

Z	De	Dp	SIMPLEX D	DUPLEX D	TRIPLEX D	Z	De	Dp	SIMPLEX D	DUPLEX D	TRIPLEX D
8	115,0	99,55	20	25	25	44	549,0	534,08	30		
9	126,4	111,40	20	25	25	45	561,2	546,20	30	40	40
10	138,0	123,29	20	25	25	46	573,3	558,32	30	40	40
11	150,0	135,21	20	25	25	47	585,4	570,43	30		
12	162,0	147,22	20	25	25	48	597,4	582,55	30	40	40
13	174,2	159,18	20	25	25	49	609,5	594,66	30		
14	186,2	171,22	20	25	25	50	621,7	606,78	30	40	40
15	198,2	183,26	20	25	25	51	633,8	618,89	30		
16	210,3	195,30	25	25	25	52	646,0	631,01	30		
17	222,3	207,34	25	25	25	53	658,0	643,13	30		
18	234,3	219,42	25	25	25	54	670,2	655,25	30		
19	246,5	231,49	25	25	25	55	682,3	667,40	30	40	40
20	258,6	243,57	25	25	25	56	694,4	679,50	30		
21	270,6	255,65	25	25	30	57	706,5	691,73	30	40	40
22	282,7	267,73	25	25	30	58	718,6	703,74	30		
23	294,8	279,80	25	25	30	59	730,7	715,86	30		
24	306,8	291,88	25	25	30	60	742,8	727,97	30	40	40
25	319,0	304,00	25	25	30	62	767,2	752,24	40		
26	331,0	316,08	30	30	30	64	791,3	776,48	40		
27	343,2	328,19	30	30	30	65	803,4	788,59	40	40	40
28	355,2	340,27	30	30	30	66	815,6	800,17	40		
29	367,3	352,38	30	30	30	68	839,8	824,98	40		
30	379,5	364,50	30	30	40	70	864,2	849,21	40		
31	391,6	376,62	30	40	40	72	888,4	873,48	40		
32	403,7	388,69	30	40	40	75	924,8	909,83	40		
33	415,8	400,81	30	40	40	76	936,9	921,98	40	40	40
34	427,8	412,93	30	40	40	80	985,4	970,44	40		
35	440,0	425,04	30	40	40	85	1046,0	1031,10	40		
36	452,0	437,16	30	40	40	95	1167,3	1152,33	40		
37	464,2	449,27	30	40	40						
38	476,2	461,39	30	40	40						
39	488,5	473,50	30	40	40						
40	500,6	485,62	30	40	40						
41	512,6	497,74	30								
42	524,7	509,85	30	40	40						
43	536,8	521,97	30								

Kettenradscheiben Plate wheels

Kettenradscheiben für Simplex-, Duplex- und Triplex-Rollenkette nach DIN 8187 - ISO/R 606
Plate wheels for simplex, duplex and triplex chain according to DIN 8187 - ISO/R 606

28B

Kette chain	mm	Kettenradscheiben plate wheels	mm
Teilung Pitch	44,45	Radius Tooth radius	r 44
Innere Breite Internal width	30,99	Breite radius width	c 5
Rollen Roller \varnothing	27,94	Zahnbreite Tooth width	h_1 29,4
		Zahnbreite Tooth width	L 28,8
		Zahnbreite Tooth width	h_2 88,4
		Zahnbreite Tooth width	h_3 148
		Gesamthöhe Full height	H —



Seitlich plan gedrehte, wälzgefräste Zahnkränze
Plate wheels turned on both sides and toothed by milling cutter

1"3/4 x 1"1/4

44,45 x 30,99 mm

Z	De	Dp	SIMPLEX D	DUPLEX D	TRIPLEX D	Z	De	Dp	SIMPLEX D	DUPLEX D	TRIPLEX D
8	132,0	116,15	25	25	25	27	401,0	382,88	30	30	40
9	148,4	129,96	25	25	25	28	416,0	397,00	30	30	40
10	162,3	143,85	25	25	25	29	430,0	411,12	30	30	40
11	176,3	157,77	25	25	30	30	444,0	425,24	30	30	40
12	189,3	171,74	25	25	30	31	458,0	439,37	30	30	40
13	204,2	185,75	25	25	30	32	472,0	453,49	30	30	40
14	218,2	199,76	25	25	30	33	486,0	467,62	30	30	40
15	232,3	213,79	25	25	30	34	500,0	481,75	30	30	40
16	246,3	227,84	30	30	30	35	514,0	495,88	30	30	40
17	260,0	241,90	30	30	30	36	529,0	510,01	30	30	40
18	274,0	255,98	30	30	30	37	543,0	524,13	30	30	40
19	289,0	270,06	30	30	30	38	557,0	538,27	30	30	40
20	303,0	284,15	30	30	30	39	571,0	552,40	30	30	40
21	317,0	298,24	30	30	30	40	585,0	566,54	30	30	40
22	331,0	312,34	30	30	30	45	656,0	637,22	30	30	40
23	345,0	326,44	30	30	30	50	726,0	707,91	30	30	40
24	359,0	340,55	30	30	30	57	825,0	806,90	40	40	40
25	373,0	354,66	30	30	40	60	869,0	849,32	40	40	40
26	387,0	368,77	30	30	40	76	1095,0	1075,62	40	40	40

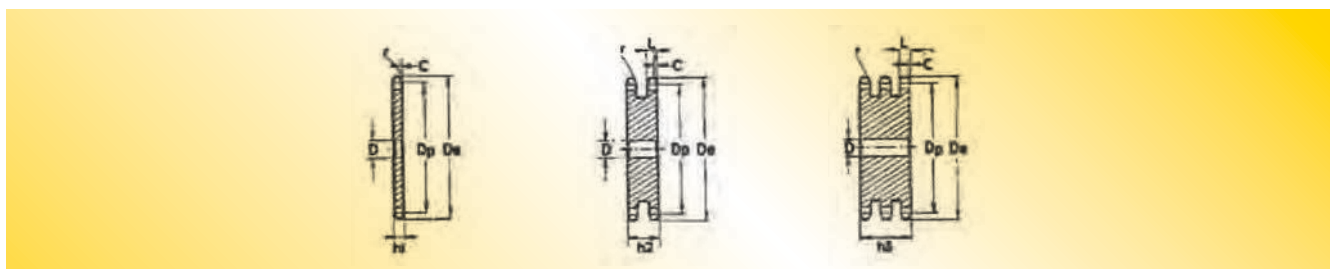

Kettenradscheiben

Plate wheels

Kettenradscheiben für Simplex-, Duplex- und Triplex-Rollenkette nach DIN 8187 - ISO/R 606
 Plate wheels for simplex, duplex and triplex chain according to DIN 8187 - ISO/R 606

32B

Kette chain	mm	Ketteradscheiben plate wheels	mm
Teilung Pitch	50,8	Radius Tooth radius	r 51
Innere Breite Internal width	30,99	Breite radius width	c 6
Rollen Roller \varnothing	29,21	Zahnbreite Tooth width	h_1 29,4
		Zahnbreite Tooth width	L 28,8
		Zahnbreite Tooth width	h_2 87,4
		Zahnbreite Tooth width	h_3 146
		Gesamthöhe Full height	H —



Seitlich plan gedrehte, wälzgefräste Zahnkränze
 Plate wheels turned on both sides and toothed by milling cutter

2" x 1"1/4

50,8 x 30,99 mm

Z	De	Dp	SIMPLEX D	DUPLEX D	TRIPLEX D	Z	De	Dp	SIMPLEX D	DUPLEX D	TRIPLEX D
8	153,2	132,74	25	25	25	24	409,7	389,18	30	30	40
9	169,0	148,54	25	25	25	25	425,8	405,33	30	30	40
10	185,0	164,39	25	25	25	26	441,9	421,44	30	30	40
11	200,8	180,31	30	30	30	27	458,1	437,59	30	30	40
12	216,8	196,29	30	30	30	28	474,2	453,69	30	30	40
13	232,8	212,29	30	30	30	29	492,0	469,85	30	30	40
14	248,8	228,29	30	30	30	30	506,5	486,00	30	30	40
15	264,8	244,30	30	30	30	32	538,8	518,27	30		
16	280,9	260,40	30	30	30	35	589,5	566,71	30	30	40
17	296,9	276,46	30	30	30	38	635,5	615,16	30	30	40
18	313,0	292,55	30	30	30	40	670,3	647,47	40	40	40
19	329,1	308,66	30	30	30	45	751,0	728,24	40	40	40
20	345,2	324,71	30	30	30	50	831,8	809,04	40	40	40
21	361,3	340,82	30	30	40	57	945,0	922,16	40	40	40
22	377,5	356,98	30	30	40	60	993,4	970,65	40	40	40
23	393,6	373,08	30	30	40	76	1252,0	1229,27	40	40	40

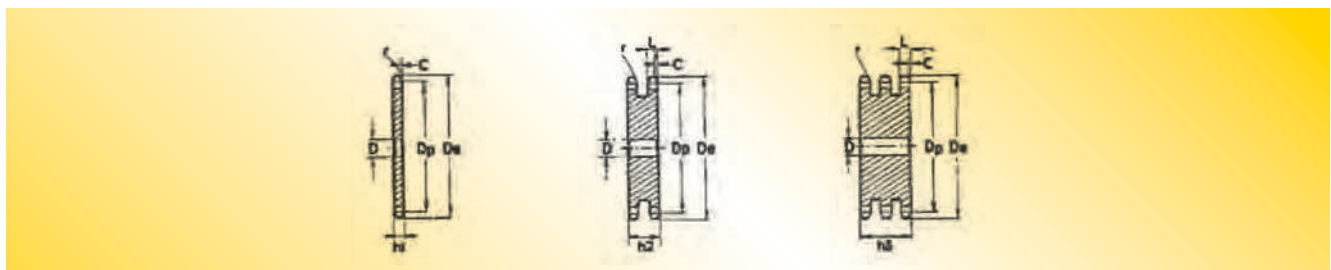

Kettenräder für Taperbuchsen Taper bored sprockets

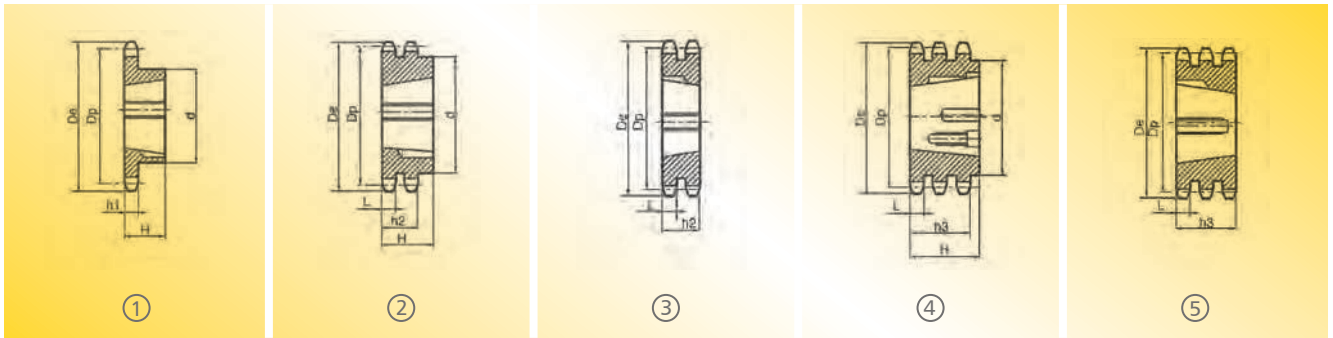

06B

Kette chain	mm	Kettenräder sprockets	mm
Teilung Pitch	9,525	Radius Tooth radius	r 10
Innere Breite Internal width	5,72	Breite radius width	c 1
Rollen Roller	∅ 6,35	Zahnbreite Tooth width	h ₁ 5,3
		Zahnbreite Tooth width	L 5,2
		Zahnbreite Tooth width	h ₂ 15,4
		Zahnbreite Tooth width	h ₃ 25,6

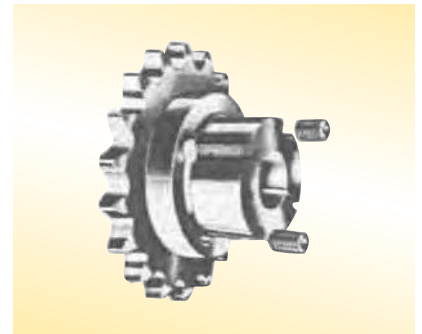

Material C 45 E - UNI EN 10083-1

3/8" x 7/32"

9,525 x 5,72 mm

Z	D _e	D _p	SIMPLEX				DUPLEX				TRIPLEX			
			d	H	für Buchse for Bush	Type	d	H	für Buchse for Bush	Type	d	H	für Buchse for Bush	Type
17	55,3	51,83	45	22	1008	1	41	22	1008	2	—	25,6	1008	5
18	58,3	54,85	45	22	1008	1	43	22	1008	2	—	25,6	1008	5
19	61,3	57,87	45	22	1008	1	46	22	1008	2	—	25,6	1008	5
20	64,3	60,89	46	22	1008	1	48	22	1008	2	—	25,6	1008	5
21	68,0	63,91	46	22	1008	1	49	22	1008	2	—	25,6	1008	5
22	71,0	66,93	50	22	1108	1	52	22	1108	2	—	25,6	1210	5
23	73,5	69,95	63	25	1210	1	59	25	1210	2	—	25,6	1210	5
24	77,0	72,97	63	25	1210	1	61	25	1210	2	—	25,6	1210	5
25	80,0	76,02	63	25	1210	1	64	25	1210	2	—	25,6	1210	5
26	83,0	79,02	63	25	1210	1	65	25	1210	2	—	25,6	1210	5
27	86,0	82,02	63	25	1210	1	70	25	1210	2	—	25,6	1210	5
28	89,0	85,07	63	25	1210	1	70	25	1210	2	—	25,6	1210	5
30	94,7	91,12	63	25	1210	1	75	25	1210	2	79	38	1615	4
38	119,5	115,35	70	25	1210	1	80	25	1610	2	90	38	1615	4
45	140,7	136,55	70	25	1210	1	80	25	1610	2				
57	176,9	172,91	70	25	1210	1	80	25	1610	2				
76	234,9	230,49	70	25	1210	1	80	25	1610	2				
95	292,5	288,08	80	25	1210	1	90	25	1610	2				
114	349,5	345,68	80	38	1215	1	95	38	1615	2				

Kettenräder für Taperbuchsen

Taper bored sprockets

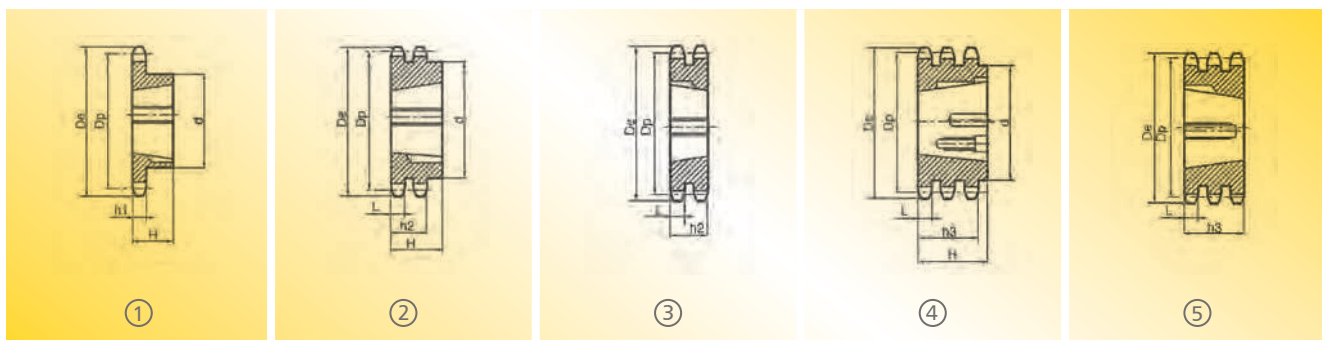

08B

Kette chain	mm	Kettenräder sprockets	mm
Teilung Pitch	12,70	Radius Tooth radius	r 13
Innere Breite Internal width	7,75	Breite radius width	c 1,3
Rollen Roller	ø 8,51	Zahnbreite Tooth width	h ₁ 7,2
		Zahnbreite Tooth width	L 7
		Zahnbreite Tooth width	h ₂ 21
		Zahnbreite Tooth width	h ₃ 34,9



Stahl Steel C 45 E - UNI EN 10083-1

1/2" x 5/16"

12,7 x 7,75 mm

Z	De	Dp	SIMPLEX				DUPLEX				TRIPLEX			
			d	H	für Buchse for Bush	Typ Type	d	H	für Buchse for Bush	Typ Type	d	H	für Buchse for Bush	Typ Type
15	65,5	61,90	45	22	1008	1	46	22	1008	2	—	34,9	1008	5
16	69,5	65,10	50	22	1108	1	50	22	1108	2	—	34,9	1210	5
17	73,6	69,11	60	25	1210	1	56	25	1210	2	—	34,9	1210	5
18	77,8	73,14	60	25	1210	1	60	25	1210	2	—	34,9	1210	5
19	81,7	77,16	63	25	1210	1	62	25	1210	2	—	34,9	1210	5
20	85,8	81,19	71	25	1610	1	66	25	1610	2	—	34,9	1610	5
21	89,7	85,22	71	25	1610	1	70	25	1610	2	—	34,9	1610	5
22	93,8	89,24	71	25	1610	1	76	25	1610	2	—	34,9	1610	5
23	98,2	93,27	76	25	1610	1	79	25	1610	2	—	34,9	1610	5
24	101,8	97,29	76	25	1610	1	84	25	1610	2	—	34,9	1610	5
25	105,8	101,33	76	25	1610	1	87	32	2012	2	—	34,9	2012	5
26	110,0	105,36	76	25	1610	1	87	32	2012	2	—	34,9	2012	5
27	114,4	109,40	76	25	1610	1	87	32	2012	2	—	34,9	2012	5
28	118,0	113,42	90	32	2012	1	87	32	2012	2	—	34,9	2012	5
30	126,1	121,50	90	32	2012	1	87	32	2012	2	—	34,9	2012	5
38	158,6	153,80	90	32	2012	1	100	32	2012	2	—	34,9	2012	5
45	188,0	182,07	100	32	2012	1	100	32	2012	2	—	34,9	2012	5
57	236,4	230,54	100	32	2012	1	100	32	2012	2	—	34,9	2012	5
76	313,3	307,33	100	32	2012	1	100	32	2012	2	—	34,9	2012	5
95	390,1	384,11	100	32	2012	1	100	32	2012	2	—	34,9	2012	5
114	466,9	460,90	110	45	2517	1	110	45	2517	2	—	34,9	2012	5

Kettenräder für Taperbuchsen Taper bored sprockets

10B

Kette chain	mm	Kettenräder sprockets	mm
Teilung Pitch	15,875	Radius Tooth radius	r 16
Innere Breite Internal width	9,65	Breite radius width	c 1,6
Rollen Roller	ø 10,16	Zahnbreite Tooth width	h ₁ 9,1
		Zahnbreite Tooth width	L 9
		Zahnbreite Tooth width	h ₂ 25,5
		Zahnbreite Tooth width	h ₃ 42,1

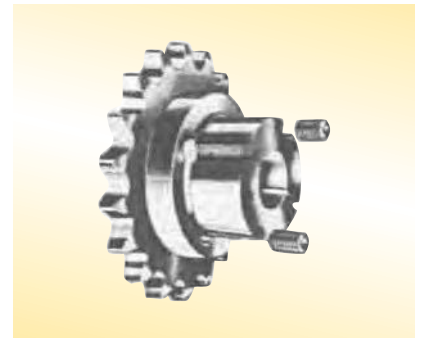

Stahl Steel C 45 E - UNI EN 10083-1

5/8" x 3/8"

15,875 x 9,65 mm

Z	De	Dp	SIMPLEX				DUPLEX				TRIPLEX			
			d	H	für Buchse for Bush	Typ Type	d	H	für Buchse for Bush	Typ Type	d	H	für Buchse for Bush	Typ Type
13	73,0	66,32	47	22	1008	1	—	25,5	1108	3				
14	78,0	71,34	52	22	1108	1								
15	83,0	76,36	60	25	1210	1	—	25,5	1210	3	—	42,1	1210	5
16	88,0	81,37	70	25	1610	1								
17	93,0	86,36	71	25	1610	1	—	25,5	1610	3	—	42,1	1210	5
18	98,3	91,42	75	25	1610	1								
19	103,3	96,45	75	25	1610	1	—	25,5	1610	3	—	42,1	1615	5
20	108,4	101,49	75	25	1610	1	—	25,5	1610	3				
21	113,4	106,52	76	25	1610	1	—	25,5	1610	3	—	42,1	1615	5
22	118,0	111,55	76	25	1610	1	—	25,5	1610	3				
23	123,4	116,58	76	25	1610	1	—	25,5	1610	3	—	42,1	2012	5
24	128,3	121,62	90	32	2012	1								
25	134,0	126,66	90	32	2012	1	90	32,0	2012	2	105	45,0	2517	4
26	139,0	131,70	90	32	2012	1								
27	144,0	136,75	90	32	2012	1	90	32,0	2012	2	110	45,0	2517	4
28	148,7	141,78	90	32	2012	1								
30	158,8	151,87	90	32	2012	1	90	32,0	2012	2	120	45,0	2517	4
38	199,2	192,24	100	32	2012	1	108	45,0	2517	2				
45	235,0	227,58	100	32	2012	1								
57	296,0	288,18	100	32	2012	1								
76	392,1	384,16	100	32	2012	1								
95	488,5	480,14	110	45	2517	1								
114	584,1	576,13	110	45	2517	1								

Kettenräder für Taperbuchsen

Taper bored sprockets

12B

Kette chain	mm	Kettenräder sprockets	mm
Teilung Pitch	19,05	Radius Tooth radius r	19
Innere Breite Internal width	11,68	Breite radius width c	2
Rollen Roller \varnothing	12,07	Zahnbreite Tooth width h_1	11,1
		Zahnbreite Tooth width L	10,8
		Zahnbreite Tooth width h_2	30,3
		Zahnbreite Tooth width h_3	49,8



Stahl Steel C 45 E - UNI EN 10083-1

3/4" x 7/16"

19,05 x 11,68 mm

Z	De	Dp	SIMPLEX				DUPLEX				TRIPLEX				
			d	H	für Buchse for Bush	Typ Type	d	H	für Buchse for Bush	Typ Type	d	H	für Buchse for Bush	Typ Type	
13	87,5	79,59	60	25	1210	1									
14	93,6	85,61	70	25	1610	1									
15	99,8	91,63	70	25	1610	1	—	30,3	1610	3	—	49,8	1615	5	
16	105,5	97,65	75	25	1610	1	—	30,3	1610	3	—	49,8	2012	5	
17	111,5	103,67	76	25	1610	1	—	30,3	1610	3	—	49,8	2012	5	
18	118,0	109,71	90	32	2012	1	90	32	2012	2	—	49,8	2012	5	
19	124,2	115,75	90	32	2012	1	90	32	2012	2	—	49,8	2012	5	
20	129,7	121,78	90	32	2012	1	108	45	2517	2					
21	136,0	127,82	102	45	2517	1	108	45	2517	2	—	49,8	2517	5	
22	141,8	133,86	102	45	2517	1	108	45	2517	2					
23	149,0	139,90	108	45	2517	1	108	45	2517	2	—	49,8	2517	5	
24	153,9	145,94	108	45	2517	1	108	45	2517	2					
25	160,0	152,00	108	45	2517	1	108	45	2517	2	—	49,8	2517	5	
26	165,9	158,04	108	45	2517	1	108	45	2517	2					
27	172,3	164,00	108	45	2517	1	108	45	2517	2	140	51	3020	4	
28	178,0	170,13	108	45	2517	1	108	45	2517	2					
30	190,5	182,25	108	45	2517	1	108	45	2517	2	140	51	3020	4	
38	239,0	230,69	108	45	2517	1	140	51	3020	2	140	51	3020	4	
45	282,5	273,10	108	45	2517	1	140	51	3020	2	140	51	3020	4	
57	355,4	345,81	108	45	2517	1	140	51	3020	2	140	51	3020	4	
76	469,9	460,99	108	45	2517	1	140	51	3020	2	140	51	3020	4	
95	585,1	576,17	108	45	2517	1	140	51	3020	2					
114	700,6	691,36	108	64	2525	1									

Kettenräder für Taperbuchsen Taper bored sprockets

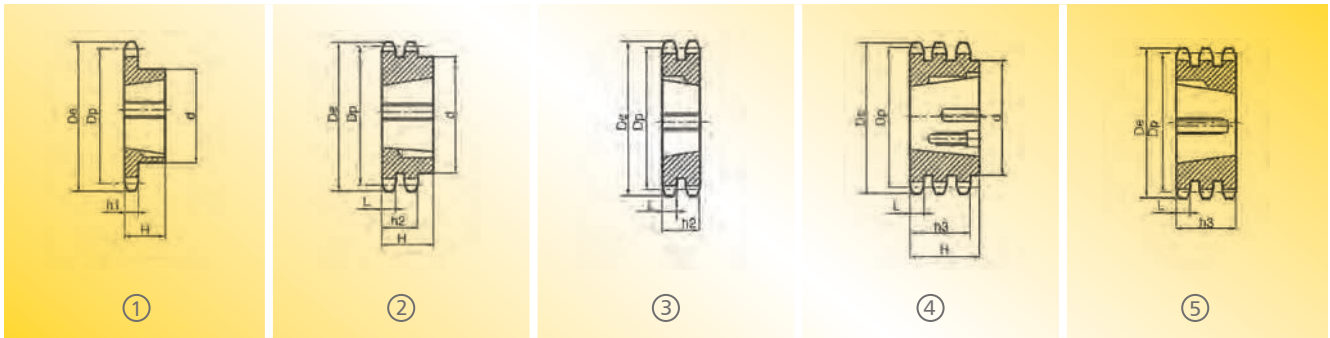

16B

Kette chain	mm	Kettenräder sprockets	mm
Teilung Pitch	25,4	Radius Tooth radius	r 26
Innere Breite Internal width	17,02	Breite radius width	c 2,5
Rollen Roller	∅ 15,88	Zahnbreite Tooth width	h ₁ 16,2
		Zahnbreite Tooth width	L 15,8
		Zahnbreite Tooth width	h ₂ 47,7
		Zahnbreite Tooth width	h ₃ 79,6



Stahl Steel C 45 E - UNI EN 10083-1

1" x 17,02 mm

25,4 x 17,02 mm

Z	D _e	D _p	SIMPLEX				DUPLEX				TRIPLEX			
			d	H	für Buchse for Bush	Typ Type	d	H	für Buchse for Bush	Typ Type	d	H	für Buchse for Bush	Typ Type
13	117,0	106,12	73	25	1610	1	—	47,7	2012	3				
14	125,0	114,15	76	25	1610	1								
15	133,0	122,17	76	25	1610	1	—	47,7	2012	3				
16	141,0	130,20	90	32	2012	1								
17	149,0	138,22	90	32	2012	1	—	47,7	2517	3	—	79,6	2517	5
18	157,0	146,28	108	45	2517	1								
19	165,2	154,33	108	45	2517	1	—	47,7	2517	3	—	79,6	3020	5
20	173,2	162,38	108	45	2517	1								
21	181,2	170,43	110	45	2517	1	140	51	3020	2	—	79,6	3030	5
22	189,3	178,48	110	45	2517	1								
23	197,5	186,53	110	45	2517	1	140	51	3020	2	—	79,6	3525	5
24	205,5	194,59	110	45	2517	1								
25	213,5	202,66	110	45	2517	1	140	51	3020	2	—	79,6	3525	5
26	221,6	210,72	110	45	2517	1								
27	229,6	218,79	110	45	2517	1	140	51	3020	2	—	79,6	3525	5
28	237,7	226,85	110	45	2517	1								
30	254,0	243,00	140	51	3020	1	140	51	3020	2	—	79,6	3525	5
38	320,7	307,59	140	51	3020	1	140	51	3020	2	—	79,6	3525	5
45	377,1	364,13	140	51	3020	1	140	51	3020	2	216	79,6	4030	5
57	474,0	461,07	140	51	3020	1	175	65	3525	2	216	79,6	4030	5
76	627,0	614,65	140	51	3020	1	175	65	3525	2	216	79,6	4030	5
95	781,1	768,22	140	51	3020	1	215	65	3525	2	240	79,6	4030	5
114	934,3	921,81	140	76	3030	1	215	102	4040	2				

Kettenräder für Taperbuchsen

Taper bored sprockets

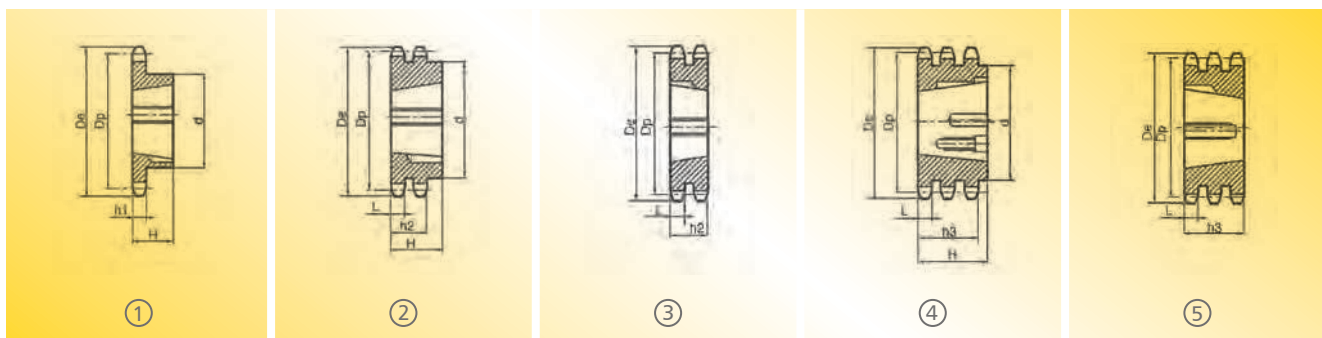

20B

Kette chain	mm	Kettenräder sprockets	mm
Teilung Pitch	31,75	Radius Tooth radius	r 32
Innere Breite Internal width	19,56	Breite radius width	c 3,5
Rollen Roller	∅ 19,05	Zahnbreite Tooth width	h ₁ 18,5
		Zahnbreite Tooth width	L 18,2
		Zahnbreite Tooth width	h ₂ 54,6
		Zahnbreite Tooth width	h ₃ 91



Stahl Steel C 45 E - UNI EN 10083-1

1" 1/4 x 3/4"

31,75 x 19,56 mm

z	De	Dp	SIMPLEX			
			d	H	für Buchse for Bush	Typ Type
13	147,8	132,65	90	32	2012	1
14	157,8	142,68	90	32	2012	1
15	167,9	152,72	108	45	2517	1
16	177,9	162,75	108	45	2517	1
17	187,9	172,78	108	45	2517	1
18	198,0	182,85	108	45	2517	1
19	208,1	192,91	108	45	2517	1
20	218,1	202,98	108	45	2517	1
21	228,2	213,04	108	45	2517	1
22	238,3	223,11	108	45	2517	1
23	248,3	233,17	108	45	2517	1
24	258,4	243,23	108	45	2517	1
25	268,5	253,33	108	45	2517	1
27	288,6	273,40	150	51	3020	1
30	318,9	303,75	150	51	3020	1
38	399,6	384,49	160	51	3020	1
45	470,3	455,17	160	51	3020	1
57	591,5	576,36	160	51	3020	1
76	783,5	768,32	160	51	3020	1

Taperbuchsen Taper bushes

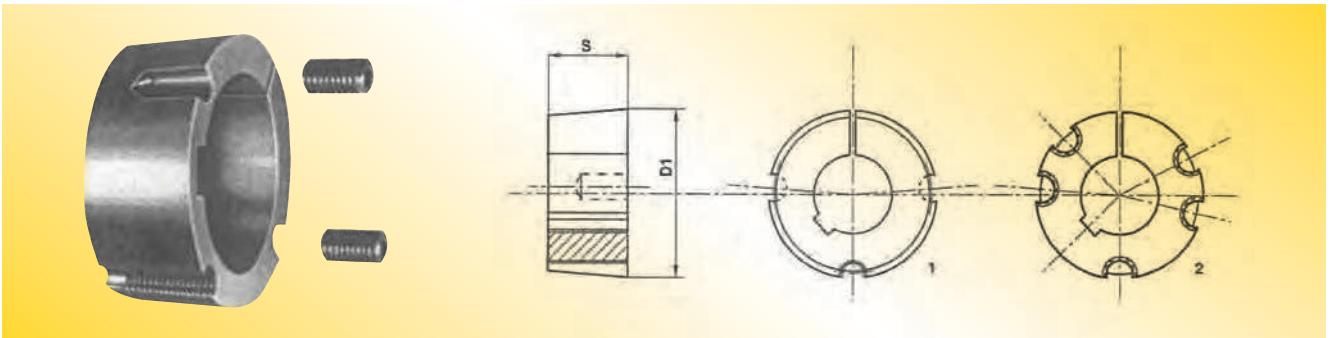

Grauguss Cast iron - EN-GJL-250 UNI EN 1561

Standard Lagerbohrung metrische Reihe Standard Stock bores metric series

für Buchse for Bush	Bohrungen Bore (ISO E 8)																Schraube Screw	Anzugs- moment Schrauben Screw tightening torque	D ₁	Typ Type	S	Gewicht weight				
	mm																						inch	Nm	mm	mm
1008	9	10	11	12	14	15	16	18	19	20	22	24*	25*					1/4 x 1/2	5,7	35,0	1	22,3	0,16			
1108	9	10	11	12	14	15	16	18	19	20	22	24	25	28*				1/4 x 1/2	5,7	38,0	1	22,3	0,16			
1210	11	12	14	15	16	18	19	20	22	24	25	28	30	32				3/8 x 5/8	20	47,5	1	25,4	0,32			
1215	14	19	20	24	25	28												3/8 x 5/8	20	47,5	1	38,1	0,50			
1610	14	15	16	18	19	20	22	24	25	28	30	32	35	38	40	42*		3/8 x 5/8	20	57,0	1	25,4	0,41			
1615	14	16	18	19	20	22	24	25	28	30	32	35	38	40	42*			3/8 x 5/8	20	57,0	1	38,1	0,60			
2012	14	16	18	19	20	22	24	25	28	30	32	35	38	40	42	45	48	50	7/16 x 7/8	31	70,0	1	31,8	0,75		
2517	16	18	19	20	22	24	25	28	30	32	35	38	40	42	45	48	50	55	60	65*	1/2 x 1	49	85,5	1	44,5	1,06
3020	25	28	30	32	35	38	40	42	45	48	50	55	60	65	70	75			5/8 x 1 1/4	92	108,0	1	50,8	2,50		
3030	35	38	40	42	45	48	50	55	60	65	70	75						5/8 x 1 1/4	92	108,0	1	76,2	3,75			
3525	35	38	40	42	45	48	50	55	60	65	70	75	80	85	90			1/2 x 1 1/2	115	127,0	2	64,9	4,20			
3535	35	38	40	42	45	48	50	55	60	65	70	75	80	85	90			1/2 x 1 1/2	115	127,0	2	88,9	5,13			
4030	40	42	45	48	50	55	60	65	70	75	80	85	90	100				5/8 x 1 1/4	172	146,0	2	76,2	6,75			
4040	40	42	45	48	50	55	60	65	70	75	80	85	90	95	100			5/8 x 1 3/4	172	146,0	2	101,6	7,68			
4545	55	60	65	70	75	80	85	90	95	100								3/4 x 2	195	162,0	2	115,0	10,56			
5040	70	75	80	85	90	95	100	105	110	115	120	125						7/8 x 2 1/4	275	177,6	2	101,6	14,20			
5050	70	75	80	85	90	95	100	105	110	115	120	125						7/8 x 2 1/4	275	177,6	2	127,0	15,17			

Abmessungen der Keilnuten (UNI 6604 DIN 6885) mit Standardbohrung, metrische Reihe Dimensions of keyways (UNI 6604 DIN 6885) with standard bore, metric series

D	b	Js9	t		Abmessungen der Keilnuten Dimensions of keyways		
					D*	b	t
Over 10 to 12	4	± 0,015	D + 1,8		24*	8	D + 1,3
Over 12 to 17	5		D + 2,3				
Over 17 to 22	6		D + 2,8				
Over 22 to 30	8	± 0,018	D + 3,3				
Over 30 to 38	10		D + 3,3				
Over 38 to 44	12		D + 3,3				
Over 44 to 50	14	± 0,021	D + 3,8				
Over 50 to 58	16		D + 4,3				
Over 58 to 65	18		D + 4,4				
Over 65 to 75	20	± 0,026	D + 4,9				
Over 75 to 85	22		D + 5,4				
Over 85 to 95	25		D + 5,4				
Over 95 to 110	28	± 0,031	D + 6,4				
Over 110 to 130	32		D + 7,4				

Führungsschienen, Kettenführungen und Riemenführungen *Guide rails, chain guides and belt guides*



Führungsschienen *guide rails*

Führungsschienen bestechen durch ihre hervorragenden Eigenschaften wie Verschleißfestigkeit, Schlagfestigkeit und Säurebeständigkeit. PTS Strongbelt verfügt über eine große Lieferfähigkeit an verschiedensten Führungsschienen. Darüber hinaus besteht die Möglichkeit, technische Kunststoffe nach Kundenwunsch zu liefern.

Guide rails feature excellent properties including wear resistance, impact strength and acid resistance. PTS Strongbelt has a huge selection of guide rails in stock. Furthermore we can supply you with other technical plastics according to your requirements.

Kettenführungen *chain guides*

Die Kettenführungen werden der DIN 8187 folgend hergestellt in A4 grün und standardmäßig in einer Länge von 2000 mm.

The chain guides are manufactured according to DIN 8187 in A4 green and with a standard length of 2000 mm.

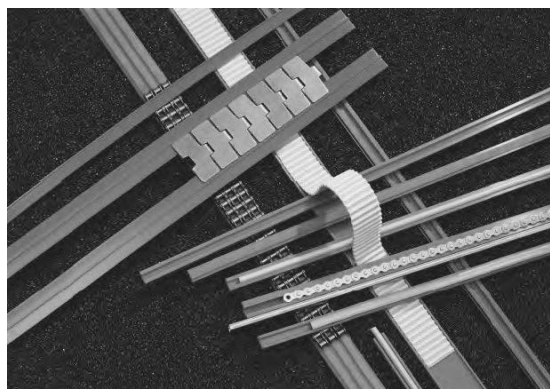

Riemenführungen *belt guides*

Die Riemenführungen werden standardmäßig in A4 grün / schwarz in einer Länge von 2000 mm produziert. Sie sind geeignet für Flachriemen, Keilriemen, Rundriemen oder auch Zahnriemen.

The belt guides are produced as standard in A4 green / black and with a length of 2000 mm. They are suitable for flat belts, v-belts, round belts or even timing belts.

Tapernaben Taper hubs



Anschraubnaben – Bolt on hubs

Bezeichnung Part No.	Material	Taper- Buchse Taper bush	DA (mm)	DT (mm)	D + 0/- 0,1 (mm)	DK (mm)	B (mm)	b (mm)	Z (mm)	BM (mm)	d (mm)	Gewicht o. Buchse Weight without bush (≈ kg)	€ Stück ohne Buchse each without bush
SM 12	GG	1210	180	135	90	75	25	6,5	2,5	11,5	6 x 7,5	1,5	auf Anfrage on request
SM 16	GG	1615	200	150	110	85	38	7,5	2,5	12,5	6 x 7,5	3,0	
SM 20	GG	2012	270	190	140	110	32	8,5	2,5	13,5	6 x 9,5		
SM 25	GG	2517	340	240	170	125	45	9,5	2,5	14,5	8 x 11,5	7,6	
SM 30-1	GG	3020	430	300	220	160	51	13,5	2,5	18,5	8 x 13,5	16,6	
SM 30-2	GG	3020	485	340	250	160	51	13,5	2,5	18,5	8 x 13,5	20,5	

Einschweißnaben Type WM – Weld on hubs type WM

Bezeichnung Part No.	Material	Taper- Buchse Taper bush	DA (mm)	D + 0/- 0,05 (mm)	DK (mm)	B + 0,5/- 0,05 (mm)	b1 (mm)	b2 (mm)	Gewicht o. Buchse Weight without bush (≈ kg)	€ Stück ohne Buchse each without bush
WM 1210	St	1210	70	60	58	25	9	10	0,3	auf Anfrage on request
WM 1615	St	1615	83	70	68	38	16	11	0,6	
WM 2012	St	2012	95	90	88	32	12	12	0,7	
WM 2517	St	2517	127	110	108	44	19	13	1,8	
WM 3030	St	3030	152	130	125	76	25	19	3,5	
WM 3535	St	3535	184	155	151	89	32	25	10,0	
WM 4040	St	4040	225	195	187	102	32	32	13,2	
WM 4545	St	4545	254	220	213	115	38	38	20,1	
WM 5050	St	5050	276	242	228	127	38	38	25,4	

Einschweißnaben Type WH – Weld on hubs type WH

Bezeichnung Part No.	Material	Taper- Buchse Taper bush	DA (mm)	D + 0/- 0,05 (mm)	DK (mm)	B + 0,5/- 0,05 (mm)	b1 (mm)	b2 (mm)	Gewicht o. Buchse Weight without bush (≈ kg)	€ Stück ohne Buchse each without bush
WH 1210	St	1210	70	65	64,5	25	9	10	0,3	auf Anfrage on request
WH 1610	St	1610	80	75	74,5	25	9	10		
WH 2012	St	2012	95	90	89,5	32	12	12		
WH 2517	St	2517	115	110	109,5	44	19	15		
WH 3020	St	3020	145	140	139,5	50	19	15	2,7	
WH 3525	St	3525	190	180	179,5	65	25	25		
WH 3535	St	3535	190	180	179,5	89	32	25	10,0	
WH 4040	St	4040	200	190	189,5	101	32	30		
WH 4545	St	4545	210	200	199,5	115	40	30		
WH 5050	St	5050	230	220	219,5	127	40	35		

Taperbuchse Taper bush	1210	1610	1615	2012	2517	3020	3030	3525	3535	4040	4545	5050
Bohrung d ₂ (mm) von ... bis ... Bore d ₂ (mm) from ... to ...	11-32	14-42	14-42	14-50	16-60	25-75	35-75	35-90	35-90	40-100	44-110	70-125
€/Stück each	auf Anfrage / on request											

Bohrungsdurchmesser d₂ siehe Seite 3-4.
Bore diameters d₂ see page 3-4.

Weitere Abmessungen auf Anfrage.
Further sizes on request.

GG = Grauguss
GG = Cast iron

St = Stahl
St = Steel

Fertigungstechnische Änderungen vorbehalten.
We reserve the right to make technical changes.

Zwischenhülsen Adapters

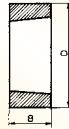

Bezeichnung Part No.	Material	Taper- Buchse Taper bush	D (mm)	B (mm)	Nutz- querschnitt Keyway dimensions b x h (mm)	Minimaler Nabendurchmesser der Scheibe Minimum hub diameter			Gewicht ohne Buchse Weight without bush (≈ kg)	€ Stück ohne Buchse each without bush
						Material				
						GG	GGG	St		
1008 AM 1008 BM	St St	1008 1008	45 45	22 22	5 x 2,5	71 75	62 67	56 60	0,1 0,1	auf Anfrage on request
1210 AM 1210 BM	St St	1210 1210	60 60	25 25	6 x 3	86 92	79 86	73 83	0,2 0,2	
1610 AM 1610 BM	St St	1610 1610	70 70	25 25	10 x 4	95 102	89 95	83 89	0,3 0,3	
1615 AM 1615 BM	St St	1615 1615	70 70	38 38	10 x 4	95 102	89 95	83 89	0,4 0,4	
2517 AM 2517 BM	St St	2517 2517	105 105	45 45	16 x 4	143 149	133 140	121 127	1,0 1,0	
3030 AM 3030 BM	St St	3030 3030	130 130	76 76	20 x 5	178 187	165 175	156 159	2,5 2,5	
3535 AM 3535 BM	St St	3535 3535	160 160	89 89	22 x 5	222 232	203 213	191 200	5,2 5,2	
4040 AM 4040 BM	St St	4040 4040	185 185	102 102	24 x 5	273 283	248 257	229 238	8,0 8,0	

St = Stahl *Steel* GG = Grauguss *Cast iron* GGG = Globularer Grauguss *Spheroidal graphite cast iron*
 AM = Ohne Keilnut *Without keyway* BM = Mit Keilnut *With keyway*

Taperbuchse <i>Taper bush</i>	1008	1210	1610	1615	2517	3030	3535	4040
Bohrung d ₂ (mm) von ... bis ... <i>Bore d₂ (mm) from ... to ...</i>	10-25	11-32	14-42	14-42	16-60	35-75	35-90	40-100
€/Stück <i>each</i>	auf Anfrage / <i>on request</i>							

Bohrungsdurchmesser d₂ siehe Seite 3-4.
Bore diameters d₂ see page 3-4.

Weitere Abmessungen auf Anfrage.
Further sizes on request.

Fertigungstechnische Änderungen vorbehalten.
We reserve the right to make technical changes.

Strongbelt

Antriebstechnik

10 **GUTE** GRÜNDE



www.strongbelt.com

Spannsätze – Technische Daten

Locking Assemblies – Technical data

Berechnung des minimalen Außendurchmessers der Nabe (DM)
 Calculation of the minimum outside diameter of hub (DM)

$$DM \geq D \cdot K$$

D = Außendurchmesser Spannsatz (mm)
 outside diameter of locking assemble (mm)

K = Faktor (siehe Tabellen)
 coefficient (see table)

Falls der Wert für „K“ in der Tabelle nicht angegeben ist, benutzen Sie bitte die folgende Formel:

To calculate the “K” value not shown in the table, use the following formula:

$$K = \sqrt{\frac{\sigma_{0,2} + (C \cdot PN)}{\sigma_{0,2} - (C \cdot PN)}} \text{ (mm)}$$

$\sigma_{0,2}$ = Streckgrenze des Materials (N/mm²)
 yield strength of the material (N/mm²)

C = Faktor ist abhängig von der Anwendung
 factor depending on the type of the application

PN = Anpressdruck der Nabe
 surface pressure of the hub



TABELLE FÜR FAKTOR "K" - COEFFICIENT "K" TABLE

	GG-20		GG-30 GTS-35 ALSi1MgMn			GGG-38 GS-400 St.42-3			GGG-50 GS-500 C-40			GGG-60 GS-600 C-45			GGG-70 GS-70 C-60												
In Abhängigkeit von der Streckgrenze in $\sigma_{0,2}$ in N/mm ² depending on the yield stress $\sigma_{0,2}$ in N/mm ²																											
	150			200			250			300			350			400			450			600					
pn N/mm ²	0,6	0,8	1	0,6	0,8	1	0,6	0,8	1	0,6	0,8	1	0,6	0,8	1	0,6	0,8	1	0,6	0,8	1	0,6	0,8	1	0,6	0,8	1
60	1,28	1,39	1,53	1,20	1,28	1,36	1,16	1,21	1,28	1,13	1,18	1,22	1,11	1,15	1,19	1,09	1,13	1,16	1,08	1,11	1,14	1,06	1,08	1,11			
65	1,30	1,44	1,59	1,22	1,30	1,40	1,17	1,24	1,30	1,14	1,19	1,25	1,12	1,16	1,21	1,10	1,14	1,18	1,09	1,12	1,16	1,07	1,09	1,11			
70	1,33	1,48	1,66	1,24	1,33	1,44	1,18	1,26	1,33	1,15	1,21	1,27	1,13	1,18	1,22	1,11	1,15	1,19	1,10	1,13	1,17	1,07	1,10	1,12			
75	1,36	1,53	1,73	1,26	1,36	1,48	1,20	1,28	1,36	1,16	1,22	1,29	1,14	1,19	1,24	1,12	1,16	1,21	1,11	1,14	1,18	1,08	1,11	1,13			
80	1,39	1,58	1,81	1,28	1,39	1,53	1,21	1,30	1,39	1,18	1,24	1,31	1,15	1,20	1,26	1,13	1,18	1,22	1,11	1,15	1,20	1,08	1,11	1,14			
85	1,42	1,63	1,90	1,30	1,42	1,57	1,23	1,32	1,42	1,19	1,26	1,34	1,16	1,22	1,28	1,14	1,19	1,24	1,12	1,16	1,21	1,09	1,12	1,15			
90	1,46	1,69	2,00	1,32	1,46	1,62	1,25	1,34	1,46	1,20	1,28	1,36	1,17	1,23	1,30	1,15	1,20	1,26	1,13	1,18	1,22	1,09	1,13	1,16			
95	1,49	1,75	2,11	1,34	1,49	1,68	1,26	1,37	1,49	1,21	1,30	1,39	1,18	1,25	1,32	1,15	1,21	1,27	1,14	1,19	1,24	1,10	1,14	1,17			
100	1,53	1,81	2,24	1,36	1,53	1,73	1,28	1,39	1,53	1,22	1,31	1,41	1,19	1,26	1,34	1,16	1,22	1,29	1,14	1,20	1,25	1,11	1,14	1,18			
105	1,56	1,88	2,38	1,39	1,56	1,79	1,29	1,42	1,56	1,24	1,23	1,44	1,20	1,28	1,36	1,17	1,24	1,31	1,15	1,21	1,27	1,11	1,15	1,19			
110	1,60	1,96	2,55	1,41	1,60	1,86	1,31	1,44	1,60	1,25	1,35	1,47	1,21	1,29	1,38	1,18	1,25	1,33	1,16	1,22	1,28	1,12	1,16	1,20			
115	1,64	2,04	2,75	1,43	1,64	1,93	1,33	1,47	1,64	1,26	1,37	1,50	1,22	1,31	1,41	1,19	1,26	1,34	1,17	1,23	1,30	1,12	1,17	1,21			
120	1,69	2,13	3,00	1,46	1,69	2,00	1,34	1,50	1,69	1,28	1,39	1,53	1,23	1,33	1,43	1,20	1,28	1,36	1,18	1,24	1,31	1,13	1,18	1,22			
125	1,73	2,24	3,32	1,48	1,73	2,08	1,36	1,53	1,73	1,29	1,41	1,56	1,24	1,34	1,45	1,21	1,29	1,38	1,18	1,25	1,33	1,13	1,18	1,24			
130	1,78	2,35	3,74	1,51	1,78	2,17	1,38	1,56	1,78	1,30	1,44	1,59	1,25	1,36	1,48	1,22	1,30	1,40	1,19	1,27	1,35	1,14	1,19	1,25			
135	1,83	2,48	4,36	1,54	1,83	2,27	1,40	1,59	1,83	1,32	1,46	1,62	1,27	1,38	1,50	1,23	1,32	1,42	1,20	1,28	1,36	1,15	1,20	1,26			
140	1,88	2,63	5,39	1,56	1,88	2,38	1,42	1,62	1,88	1,33	1,48	1,66	1,28	1,39	1,53	1,24	1,33	1,44	1,21	1,29	1,38	1,15	1,21	1,27			
145	1,94	2,80	7,68	1,59	1,94	2,50	1,44	1,65	1,94	1,35	1,50	1,69	1,29	1,41	1,55	1,25	1,35	1,46	1,22	1,30	1,40	1,16	1,22	1,28			
150	2,00	3,00		1,62	2,00	2,65	1,46	1,69	2,00	1,36	1,53	1,73	1,30	1,43	1,58	1,26	1,36	1,48	1,22	1,31	1,41	1,16	1,22	1,29			
155	2,06	3,25		1,65	2,06	2,81	1,48	1,72	2,06	1,38	1,55	1,77	1,31	1,45	1,61	1,27	1,38	1,51	1,23	1,33	1,43	1,17	1,23	1,30			
160	2,13	3,55		1,69	2,13	3,00	1,50	1,76	2,13	1,39	1,58	1,81	1,33	1,47	1,64	1,28	1,39	1,53	1,24	1,34	1,45	1,18	1,24	1,31			
165	2,21	3,96		1,72	2,21	3,23	1,52	1,80	2,21	1,41	1,60	1,86	1,34	1,49	1,67	1,29	1,41	1,55	1,25	1,35	1,47	1,18	1,25	1,33			
170	2,29	4,52		1,76	2,29	3,51	1,54	1,84	2,29	1,42	1,63	1,90	1,35	1,51	1,70	1,30	1,42	1,57	1,26	1,37	1,49	1,19	1,26	1,34			
180	2,40	7,00		1,83	2,48	4,36	1,59	1,93	2,48	1,46	1,69	2,00	1,38	1,55	1,77	1,32	1,46	1,62	1,28	1,39	1,53	1,20	1,28	1,36			
190	2,71			1,91	2,71	6,24	1,64	2,03	2,71	1,49	1,75	2,11	1,40	1,59	1,84	1,34	1,49	1,68	1,30	1,42	1,57	1,21	1,30	1,39			
200	3,00			2,00	3,00		1,69	2,13	3,00	1,53	1,81	2,24	1,43	1,64	1,91	1,36	1,53	1,73	1,31	1,45	1,61	1,22	1,31	1,41			
210	3,39			2,10	3,39		1,74	2,26	3,39	1,56	1,88	2,38	1,46	1,69	2,00	1,39	1,56	1,79	1,33	1,48	1,66	1,24	1,33	1,44			
220	3,96			2,21	3,96		1,80	2,40	3,96	1,60	1,96	2,55	1,49	1,74	2,09	1,41	1,60	1,86	1,35	1,51	1,71	1,25	1,35	1,47			
230	4,90			2,33	4,90		1,86	2,56	4,90	1,64	2,04	2,75	1,52	1,79	2,20	1,43	1,64	1,93	1,37	1,54	1,76	1,26	1,37	1,50			
240	7,00			2,48	7,00		1,93	2,76	7,00	1,69	2,13	3,00	1,55	1,85	2,32	1,46	1,69	2,00	1,39	1,58	1,81	1,28	1,39	1,53			
250				2,65			2,00	3,00		1,73	2,24	3,32	1,58	1,91	2,45	1,48	1,73	2,08	1,41	1,61	1,87	1,29	1,41	1,56			
300				4,36			2,48	7,00		2,00	3,00		1,77	2,32	3,61	1,62	2,00	2,65	1,53	1,81	2,24	1,36	1,53	1,73			

Spannsätze – Selbstzentrierend „BK 11“ Locking Assemblies – Self-centering „BK 11“

- Für sehr hohe Drehmomente geeignet
suitable for very high torques
- Toleranzen: Welle h8 - Nabe H8
tolerances: shaft h8 – hub H8
- Oberflächenrauigkeit: R_t max 16 μ m
surface roughness: R_t max 16 μ m
- Rundlauffehler: 0,02 mm \div 0,04 mm
concentricity error: 0,02 mm \div 0,04 mm

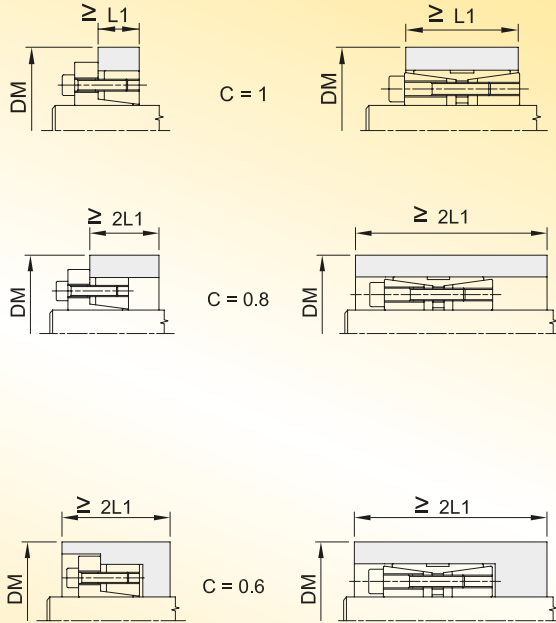
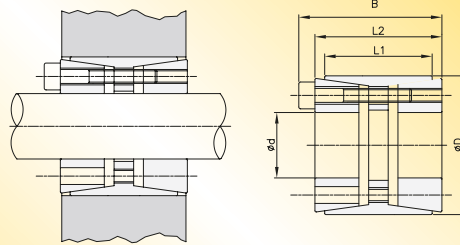

Abmessung dimension				Übertragbares Drehmoment transferable torque	Axialkraft axial force	Flächenpressung zwischen pressure between		Spannschrauben tensioning screws			Gewicht weight
d x D mm	L1 mm	L2 mm	B mm			Mt Nm	F ax. KN	Spannsatz und locking assembly and		DIN 912 12,9	
						Welle shaft	Nabe hub	Anzahl quantity	Typ	Ms Nm	kg
25 x 55	32	40	46	799	64	314	107	6	M6x35	17	0,50
28 x 55	32	40	46	895	64	281	107	6	M6x35	17	0,60
30 x 55	32	40	46	959	64	262	107	6	M6x35	17	0,60
35 x 60	44	54	60	1306	75	185	83	7	M6x45	17	0,70
38 x 75	44	54	62	2567	135	308	121	7	M8x50	41	0,70
40 x 75	44	54	62	2702	135	293	121	7	M8x50	41	0,70
42 x 75	44	54	62	2837	135	279	121	7	M8x50	41	1,00
45 x 75	44	54	62	3040	135	260	121	7	M8x50	41	0,90
48 x 80	56	64	62	3707	154	216	102	8	M8x55	41	1,40
50 x 80	56	64	72	3861	154	207	102	8	M8x55	41	1,30
55 x 85	56	64	72	4779	174	212	108	9	M8x55	41	1,50
60 x 90	56	64	72	5793	193	216	113	10	M8x55	41	1,60
65 x 95	56	64	72	6276	193	199	107	10	M8x55	41	1,80
70 x 110	70	78	88	10951	313	235	120	10	M10x60	83	3,00
75 x 115	70	78	88	11733	313	220	115	10	M10x60	83	3,30
80 x 120	70	78	88	13768	344	227	121	11	M10x60	83	3,50
85 x 125	70	78	88	15959	376	233	127	12	M10x60	83	3,70
90 x 130	70	78	88	16898	376	220	122	12	M10x60	83	3,80
95 x 135	70	78	88	17837	376	208	117	12	M10x60	83	5,00
100 x 145	90	100	112	25029	501	211	113	11	M12x80	145	6,00
110 x 155	90	100	112	30039	546	209	115	12	M12x80	145	6,20
120 x 165	90	100	112	38226	637	224	127	14	M12x80	145	7,20
130 x 180	104	116	130	48270	743	201	117	12	M14x90	230	10,00
140 x 190	104	116	130	60654	866	217	129	14	M14x90	230	10,20
150 x 200	104	116	130	69628	928	217	132	15	M14x90	230	10,80
160 x 210	104	116	130	79220	990	217	134	16	M14x90	230	11,50
170 x 225	134	148	164	100851	1186	206	116	14	M16x110	360	17,00
180 x 235	134	148	164	114414	1271	208	119	15	M16x110	360	17,05
190 x 250	134	148	164	128814	1356	210	119	16	M16x110	360	21,50
200 x 260	134	148	164	135594	1356	200	115	16	M16x110	360	22,00
220 x 285	134	148	164	167805	1526	204	118	18	M16x110	360	25,00

Spannsätze – Selbstzentrierend „BK 13“ Locking Assemblies – Self-centering „BK 13“

- Für sehr hohe Drehmomente geeignet
suitable for very high torques
- Toleranzen: Welle h8 - Nabe H8
tolerances: shaft h8 – hub H8
- Oberflächenrauigkeit: R_t max 16 μm
surface roughness: R_t max 16 μm
- Rundlauffehler: 0,02 mm \div 0,04 mm
concentricity error: 0,02 mm \div 0,04 mm
- Kurze Einbauzeit
short installation time
- Bei der Montage kann eine leichte Verschiebung von der Welle zur Nabe auftreten
during the installation, a slight shift from the shaft to the hub might occur

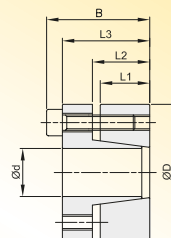
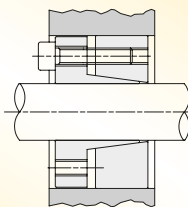

Abmessung dimension					Übertragbares Drehmoment transferable torque	Axialkraft axial force	Flächenpressung zwischen pressure between		Spannschrauben tensioning screws			Gewicht weight
d x D mm	L1 mm	L2 mm	L3 mm	B mm			Welle shaft	Nabe hub	DIN 912 12,9		Anzugs- moment tightening torque	
					Mt Nm	F ax. KN	pw N/mm ²	pn N/mm ²	Anzahl quantity	Typ	Ms Nm	kg
19 x 47	17	22	28	34	273	29	262	106	5	M6x20	13	0,30
20 x 47	17	22	28	34	287	29	249	106	5	M6x20	13	0,30
22 x 47	17	22	28	34	316	29	227	106	5	M6x20	13	0,30
24 x 50	17	22	28	34	413	34	249	120	6	M6x20	13	0,30
25 x 50	17	22	28	34	431	34	239	120	6	M6x20	13	0,30
28 x 55	17	22	28	34	482	34	213	109	6	M6x20	13	0,40
30 x 55	17	22	28	34	517	34	199	109	6	M6x20	13	0,30
32 x 60	17	22	28	34	734	46	249	133	8	M6x20	13	0,40
35 x 60	17	22	28	34	803	46	227	133	8	M6x20	13	0,40
38 x 65	17	22	28	34	872	46	210	122	8	M6x20	13	0,40
40 x 65	17	22	28	34	918	46	199	122	8	M6x20	13	0,40
42 x 75	20	25	33	41	1563	74	261	146	7	M8x25	32	0,80
45 x 75	20	25	33	41	1674	74	244	146	7	M8x25	32	0,60
50 x 80	20	25	33	41	1860	74	219	137	7	M8x25	32	0,80
55 x 85	20	25	33	41	2340	85	228	148	8	M8x25	32	0,80
60 x 90	20	25	33	41	2553	85	209	139	8	M8x25	32	0,80
65 x 95	20	25	33	41	3110	96	217	149	9	M8x25	32	0,90
70 x 110	24	30	40	50	4838	138	243	154	8	M10x30	65	1,59
75 x 115	24	30	40	50	5184	138	226	148	8	M10x30	65	1,80
80 x 120	24	30	40	50	5530	138	212	142	8	M10x30	65	1,80
85 x 125	24	30	40	50	6610	156	225	153	9	M10x30	65	2,00
90 x 130	24	30	40	50	6998	156	212	147	9	M10x30	65	2,10
95 x 135	24	30	40	50	8208	173	223	157	10	M10x30	65	2,10
100 x 145	26	32	44	56	9742	195	221	152	8	M12x35	110	2,80
110 x 155	26	32	44	56	10716	195	201	143	8	M12x35	110	3,00
120 x 165	26	32	44	56	13154	219	207	151	9	M12x35	110	3,20
130 x 180	34	40	52	64	18996	292	195	141	12	M12x35	110	4,80
140 x 190	34	40	54	68	20336	291	180	133	9	M14x40	170	5,20
150 x 200	34	40	54	68	24211	323	187	140	10	M14x40	170	5,40
160 x 210	34	40	54	68	28408	355	192	147	11	M14x40	170	5,70
170 x 225	44	50	64	78	32929	387	153	115	12	M14x40	170	8,00
180 x 235	44	50	64	78	34866	387	144	110	12	M14x40	170	8,30

Spannsätze – Selbstzentrierend „BK 15“ Locking Assemblies – Self-centering „BK 15“

- Für sehr hohe Drehmomente geeignet
suitable for very high torques
- Toleranzen: Welle h8 - Nabe H8
tolerances: shaft h8 – hub H8
- Oberflächenrauigkeit: R_t max 16 μ m
surface roughness: R_t max 16 μ m
- Rundlauffehler: 0,02 mm \div 0,04 mm
concentricity error: 0,02 mm \div 0,04 mm
- Kurze Einbauzeit
short installation time

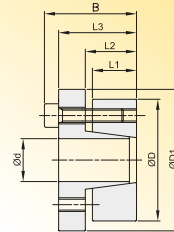
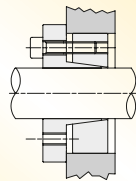

							Flächenpressung zwischen pressure between		Spannschrauben tensioning screws				
Abmessung dimension						Übertragbares Drehmoment transferable torque	Axialkraft axial force	Spannsatz und locking assembly and		DIN 912 12,9	Anzugs- moment tightening torque	Gewicht weight	
d x D mm	L1 mm	L2 mm	L3 mm	B mm	D1 mm			Welle shaft	Nabe hub				
						Mt Nm	F ax. KN	pw N/mm ²	pn N/mm ²	Anzahl quantity	Typ	Ms Nm	kg
14 x 55	17	22	31	39	62	234	33	415	106	4	M8x25	37	0,50
16 x 55	17	22	31	39	62	268	33	363	106	4	M8x25	37	0,50
18 x 55	17	22	31	39	62	333	37	357	117	4	M8x25	41	0,50
19 x 55	17	22	31	39	62	352	37	338	117	4	M8x25	41	0,50
20 x 55	17	22	31	39	62	370	37	321	117	4	M8x25	41	0,50
22 x 55	17	22	31	39	62	407	37	292	117	4	M8x25	41	0,50
24 x 55	17	22	31	39	62	445	37	268	117	4	M8x25	41	0,50
25 x 55	17	22	31	39	62	463	37	257	117	4	M8x25	41	0,50
28 x 55	17	22	31	39	62	519	37	229	117	4	M8x25	41	0,40
30 x 55	17	22	31	39	62	556	37	214	117	4	M8x25	41	0,40
24 x 65	17	22	31	39	72	556	46	335	124	5	M8x25	41	0,70
25 x 65	17	22	31	39	72	579	46	321	124	5	M8x25	41	0,70
28 x 65	17	22	31	39	72	649	46	287	124	5	M8x25	41	0,60
30 x 65	17	22	31	39	72	695	46	268	124	5	M8x25	41	0,60
32 x 65	17	22	31	39	72	741	46	251	124	5	M8x25	41	0,60
35 x 65	17	22	31	39	72	811	46	230	124	5	M8x25	41	0,50
38 x 65	17	22	31	39	72	880	46	211	124	5	M8x25	41	0,50
40 x 65	17	22	31	39	72	927	46	201	124	5	M8x25	41	0,50
30 x 80	20	25	33	41	87	972	65	318	119	7	M8x25	41	1,00
32 x 80	20	25	33	41	87	1037	65	299	119	7	M8x25	41	1,00
35 x 80	20	25	33	41	87	1134	65	273	119	7	M8x25	41	1,00
38 x 80	20	25	33	41	87	1231	65	251	119	7	M8x25	41	1,00
40 x 80	20	25	33	41	87	1296	65	239	119	7	M8x25	41	0,90
42 x 80	20	25	33	41	87	1361	65	227	119	7	M8x25	41	0,90
45 x 80	20	25	33	41	87	1458	65	212	119	7	M8x25	41	0,80
48 x 80	20	25	33	41	87	1555	65	199	119	7	M8x25	41	0,80
50 x 80	20	25	33	41	87	1620	65	191	119	7	M8x25	41	0,80

Spannsätze – Selbstzentrierend „BK 16“ Locking Assemblies – Self-centering „BK 16“

- Für sehr hohe Drehmomente geeignet
suitable for very high torques
- Toleranzen: Welle h8 - Nabe H8
tolerances: shaft h8 – hub H8
- Oberflächenrauigkeit: R_t max 16 μ m
surface roughness: R_t max 16 μ m
- Rundlauffehler: 0,02 mm \div 0,04 mm
concentricity error: 0,02 mm \div 0,04 mm
- Kurze Einbauzeit
short installation time

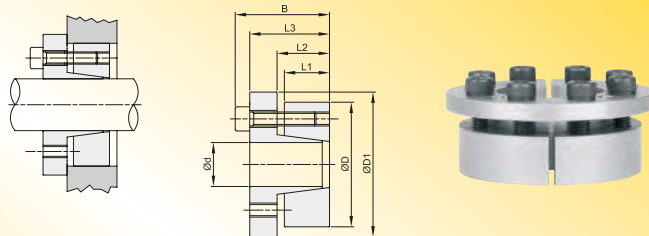

							Flächenpressung zwischen pressure between		Spannschrauben tensioning screws				
Abmessung dimension						Übertragbares Drehmoment transferable torque	Axialkraft axial force	Spannsatz und locking assembly and		DIN 912 12,9	Anzugs- moment tightening torque	Gewicht weight	
d x D mm	L1 mm	L2 mm	L3 mm	B mm	D1 mm			Welle shaft	Nabe hub				Anzahl quantity
19 x 47	17	22	28	34	56	243	26	234	94	5	M6x20	17	0,30
20 x 47	17	22	28	34	56	256	26	222	94	5	M6x20	17	0,30
22 x 47	17	22	28	34	56	282	26	202	94	5	M6x20	17	0,30
24 x 50	17	22	28	34	59	368	31	222	106	6	M6x20	17	0,30
25 x 50	17	22	28	34	59	383	31	213	106	6	M6x20	17	0,30
28 x 55	17	22	28	34	64	429	31	190	97	6	M6x20	17	0,40
30 x 55	17	22	28	34	64	460	31	177	97	6	M6x20	17	0,40
32 x 60	17	22	28	34	69	655	41	222	118	8	M6x20	17	0,40
35 x 60	17	22	28	34	69	716	41	203	118	8	M6x20	17	0,40
38 x 65	17	22	28	34	74	778	41	187	109	8	M6x20	17	0,50
40 x 65	17	22	28	34	74	819	41	178	109	8	M6x20	17	0,50
42 x 75	20	25	33	41	84	1361	65	227	127	7	M8x25	41	0,80
45 x 75	20	25	33	41	84	1458	65	212	127	7	M8x25	41	0,70
50 x 80	20	25	33	41	84	1620	65	191	119	7	M8x25	41	0,80
55 x 85	20	25	33	41	94	2037	74	199	129	8	M8x25	41	0,90
60 x 90	20	25	33	41	99	2223	74	182	121	8	M8x25	41	0,90
65 x 95	20	25	33	41	104	2710	83	189	126	9	M8x25	41	1,00
70 x 110	24	30	40	50	119	4203	120	211	134	8	M10x30	83	1,90
75 x 115	24	30	40	50	124	4754	120	197	128	8	M10x30	83	2,00
80 x 120	24	30	40	50	129	4804	120	184	123	8	M10x30	83	2,00
85 x 125	24	30	40	50	134	5742	135	195	133	9	M10x30	83	2,00
90 x 130	24	30	40	50	139	6080	135	184	128	9	M10x30	83	2,20
95 x 135	24	30	40	50	144	7131	150	194	137	10	M10x30	83	2,30
100 x 145	26	32	44	56	154	8732	175	198	137	8	M12x35	145	3,00
110 x 155	26	32	44	56	164	9605	175	180	128	8	M12x35	145	3,20
120 x 165	26	32	44	56	174	11787	196	186	135	9	M12x35	145	3,40
130 x 180	34	40	52	64	189	17024	262	175	126	12	M12x35	145	5,20
140 x 190	34	40	54	68	199	18703	267	166	122	9	M14x40	230	5,40
150 x 200	34	40	54	68	209	22259	297	172	129	10	M14x40	230	5,70
160 x 210	34	40	54	68	219	26119	326	177	135	11	M14x40	230	6,00
170 x 225	44	50	64	78	234	30276	356	140	106	12	M14x40	230	8,30
180 x 235	44	50	64	78	244	32057	356	133	102	12	M14x40	230	8,80

Spannsätze – Selbstzentrierend „BK 19“ Locking Assemblies – Self-centering „BK 19“

- Für sehr hohe Drehmomente geeignet *suitable for very high torques*
- Toleranzen: Durchmesser d h8 *tolerances: diameter d h8*
- Toleranzen: Durchmesser dw *tolerances: diameter dw*
 von *from* 18 mm bis *up to* 30 mm H6/j6
 von *from* 30 mm bis *up to* 50 mm H6/h6
 von *from* 50 mm bis *up to* 80 mm H6/g6
 von *from* 80 mm bis *up to* 500 mm H7/g6
- Oberflächenrauigkeit: $R_t \max 16 \mu\text{m}$ *surface roughness: $R_t \max 16 \mu\text{m}$*
- Kurze Einbauzeit *short installation time*

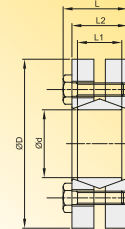
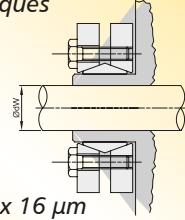

						Flächen- pressung pressure			Spannschrauben tensioning screws			
Abmessung dimension						zwischen Welle between shaft	Übertragbares Drehmoment transferable torque	Axialkraft axial force	DIN 931 10,9		Anzugs- moment tightening torque	Gewicht weight
d mm	dw mm	D mm	L1 mm	L2 mm	L mm	pw N/mm ²	Mt Nm	F ax. KN	Anzahl quantity	Typ	Ms Nm	kg
24	19	50	14	19,5	23	272	162	15,0	6	M5x18	4,9	0,20
	20						200	18,5				
	21						238	21,0				
30	24	60	16	21,5	25	221	285	15,7	7	M5x18	4,9	0,30
	25						323	23,7				
	26						361	26,7				
							418	27,0				
36	28	72	18	23,5	27,5	292	542	38,0	5	M6x20	11,8	0,40
	30						599	43,0				
	31											
							589	44,0				
44	32	80	20	25,5	29,5	301	741	49,0	7	M6x20	11,8	0,60
	35						817	54,0				
	36											
							893	48,8				
50	38	90	22	27,5	31,5	275	1102	58,8	8	M6x25	11,8	0,80
	40						1311	69,0				
	42											
							1102	48,0				
55	42	100	23	30,5	34,5	239	1444	61,7	8	M6x25	11,8	1,10
	45						1786	77,0				
	48											
							1758	69,0				
62	48	110	23	30,5	34,5	265	2090	80,9	10	M6x25	11,8	1,30
	50						2280	90,0				
	52											
							1900	71,2				
68	50	115	23	30,5	34,5	242	2375	80,9	10	M6x25	11,8	1,40
	55						2993	95,7				
	60											
							2375	94,4				
75	55	138	25	32,5	37,8	259	3040	111,0	7	M8x30	29,4	1,70
	60						3753	126,0				
	65											
							3040	99,3				
80	60	145	25	32,5	37,8	243	7505	115,0	7	M8x30	29,4	1,90
	65						4370	130,0				
	70											
							4513	141,0				
90	65	155	30	39	44,3	257	5700	160,0	10	M8x35	29,4	3,30
	70						6888	178,0				
	75											
							6555	163,0				
100	70	170	34	44	49,3	245	7125	182,0	12	M8x35	29,4	4,70
	75						8550	202,0				
	80											
							6840	185,0				
110	75	185	39	50	56,4	232	8550	207,0	9	M10x40	57,8	5,90
	80						10260	221,0				
	85											
							10450	240,0				
125	85	215	42	54	60,4	253	12350	262,0	12	M10x40	57,8	8,30
	90						14250	285,0				
	95											
							14345	308,0				
140	95	230	46	60,5	68	251	16720	331,0	10	M12x45	98	10,00
	100						19095	357,0				
	105											
							20900	366,0				
155	105	265	50	64,5	72	250	23750	392,0	12	M12x50	98	15,00
	110						26600	417,0				
	115											
							29450	513,0				
165	115	290	56	71	81	263	33250	544,0	8	M16x55	245	22,00
	120						37050	564,0				
	125											
							34200	576,0				
175	125	300	56	71	81	248	38950	630,0	8	M16x55	250	22,00
	130											
	135											
							45000	666,0				

Spannsätze – Nicht selbstzentrierend „BK 25“ Locking Assemblies – Not self-centering „BK 25“

- Für sehr hohe Drehmomente geeignet
suitable for very high torques
- Toleranzen: Welle h8 - Nabe H8
tolerances: shaft h8 – hub H8
- Oberflächenrauigkeit: R_t max 16 μ m
surface roughness: R_t max 16 μ m
- Kurze Einbauzeit
short installation time

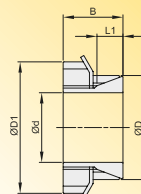
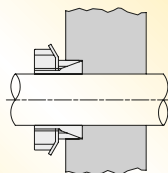

Abmessung dimension				Übertragbares Drehmoment transferable torque	Axialkraft axial force	Flächenpressung zwischen pressure between		Schrauben- größe screw dimension	Anzugs- moment tightening torque	Gewicht weight
d x D mm	L1 mm	B mm	D1 mm			Spannsatz und locking assembly and Welle shaft	Nabe hub			
				Mt Nm	F ax. KN	pw N/mm ²	pn N/mm ²	Typ	Ms Nm	kg
17 x 26	6,5	18	38	55	6	197	112	KM5	160	0,07
18 x 26	6,5	18	38	58	6	186	112	KM5	160	0,07
22 x 32	6,5	18	45	96	8	202	127	KM6	220	0,08
28 x 36	7	19,5	52	150	10	176	123	KM7	340	0,15
32 x 42	8	21,5	58	210	12	167	120	KM8	480	0,18
36 x 45	8	21,5	58	240	13	149	120	KM8	480	0,16
38 x 48	10	24,5	65	290	14	126	93	KM9	680	0,28
42 x 55	10	25,5	70	370	17	131	96	KM10	870	0,23
48 x 62	10	25,5	75	500	21	135	105	KM11	970	0,31
50 x 62	10	25,5	75	520	21	130	105	KM11	970	0,32
55 x 68	12	27,5	80	610	22	103	84	KM12	1100	0,38
56 x 68	12	27,5	80	620	22	101	82	KM12	1100	0,39
60 x 73	12	28,5	85	800	27	113	93	KM13	1300	0,43
63 x 79	14	30,5	92	980	31	107	86	KM14	1600	0,47
65 x 79	14	30,5	92	1010	31	104	86	KM14	1600	0,50
70 x 84	14	31,5	98	1240	35	110	92	KM15	2000	0,65

Spannsätze – Selbstzentrierend „BK 26“ Locking Assemblies – Self-centering „BK 26“

- Für sehr hohe Drehmomente geeignet
suitable for very high torques
- Toleranzen: Welle h8 - Nabe H8
tolerances: shaft h8 – hub H8
- Oberflächenrauigkeit: R_t max 16 μ m
surface roughness: R_t max 16 μ m
- Schnelle Montage und Demontage
fast installation and disassembling

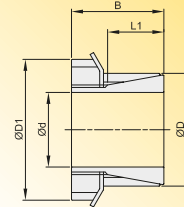
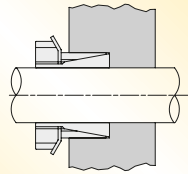

Abmessung dimension				Übertragbares Drehmoment transferable torque	Axialkraft axial force	Flächenpressung zwischen pressure between		Schraubengröße screw dimension		Anzugs- moment tightening torque	Gewicht weight
d x D mm	L1 mm	B mm	D1 mm			Mt Nm	F ax. KN	Spannsatz und locking assembly and Welle shaft	Nabe hub		
15 x 25	20	31	32	77	9	pw	pn	1	M20x1	95	0,11
18 x 30	21	33	38	125	13	98	59	1	M25x1,5	160	0,13
19 x 30	21	33	38	132	13	93	59	1	M25x1,5	160	0,13
20 x 30	21	33	38	139	13	88	59	1	M25x1,5	160	0,15
24 x 35	25	38	45	202	15	74	51	1	M30x1,5	220	0,17
25 x 35	25	38	45	210	15	71	51	1	M30x1,5	220	0,17
28 x 40	28	44	52	312	20	76	53	1	M35x1,5	340	0,28
30 x 40	28	44	52	335	20	71	53	1	M35x1,5	340	0,26
35 x 45	28	45	58	483	25	75	58	1	M40x1,5	480	0,26
40 x 50	28	46	65	696	31	82	66	1	M45x1,5	680	0,33
45 x 55	28	47	70	902	36	84	69	1	M50x1,5	870	0,45
50 x 60	28	47	75	1014	37	77	64	1	M55x2	970	0,66
55 x 65	28	48	80	1158	38	73	61	1	M60x2	1100	0,72
60 x 70	28	50	85	1379	41	73	62	1	M65x2	1300	0,80

Spannsätze – Nicht selbstzentrierend „BK 40“ Locking Assemblies – Not self-centering „BK 40“

- Für sehr hohe Drehmomente geeignet *suitable for very high torques*
- Toleranzen: Welle h11 - Nabe H11 *tolerances: shaft h11 – hub H11*
- Oberflächenrauigkeit: R_t max 16 μm
surface roughness: R_t max 16 μm
- Um eine gute Rundlaufgenauigkeit zu erreichen
ist es notwendig Welle und Nabe genau auszurichten
*in order to achieve a good concentricity it is necessary to
align the shaft and hub exactly*

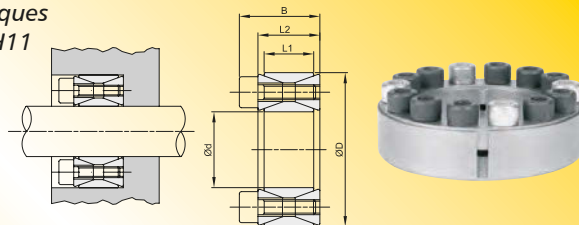

Abmessung dimension				Übertragbares Drehmoment transferable torque	Axialkraft axial force	Flächenpressung zwischen pressure between		Schraubengröße screw dimension		Anzugs- moment tightening torque	Gewicht weight
d x D mm	L1 mm	L2 mm	B mm			Spannsatz und locking assembly and	Welle shaft	Nabe hub	Anzahl quantity		
				Mt Nm	F ax. KN	pw N/mm ²	pn N/mm ²			Ms Nm	kg
19 x 47	17	20	26	298	31	286	116	8	M6x18	14,9	0,25
20 x 47	17	20	26	313	31	272	116	8	M6x18	14,9	0,24
22 x 47	17	20	26	345	31	247	116	8	M6x18	14,9	0,23
24 x 50	17	20	26	424	35	255	123	9	M6x18	14,9	0,26
25 x 50	17	20	26	441	35	245	123	9	M6x18	14,9	0,25
28 x 55	17	20	26	549	39	243	124	10	M6x18	14,9	0,30
30 x 55	17	20	26	588	39	227	124	10	M6x18	14,9	0,29
32 x 60	17	20	26	752	47	255	136	12	M6x18	14,9	0,30
35 x 60	17	20	26	822	47	233	136	12	M6x18	14,9	0,32
38 x 65	17	20	26	1042	55	250	146	14	M6x18	14,9	0,36
40 x 65	17	20	26	1097	55	238	146	14	M6x18	14,9	0,34
42 x 75	20	24	32	1740	83	291	163	12	M8x22	35	0,48
45 x 75	20	24	32	1864	83	271	163	12	M8x22	35	0,57
48 x 80	20	24	32	1988	83	254	153	12	M8x22	35	0,59
50 x 80	20	24	32	2071	83	244	153	12	M8x22	35	0,60
55 x 85	20	24	32	2658	97	259	168	14	M8x22	35	0,63
60 x 90	20	24	32	2900	97	238	158	14	M8x22	35	0,69
65 x 95	20	24	32	3587	110	250	171	16	M8x22	35	0,73
70 x 110	24	28	38	5345	153	268	171	14	M10x25	69	1,26
75 x 115	24	28	38	5727	153	250	163	14	M10x25	69	1,33
80 x 120	24	28	38	6108	153	235	156	14	M10x25	69	1,40
85 x 125	24	28	38	7417	175	252	172	16	M10x25	69	1,49
90 x 130	24	28	38	7854	175	238	165	16	M10x25	69	1,53
95 x 135	24	28	38	9326	196	254	179	18	M10x25	69	1,62
100 x 145	26	33	45	11362	227	258	178	14	M12x30	123,3	2,01
110 x 155	26	33	45	12498	227	234	166	14	M12x30	123,3	2,15
120 x 165	26	33	45	15578	260	245	178	16	M12x30	123,3	2,35
130 x 180	34	38	50	21095	325	217	156	20	M12x35	123,3	3,51
140 x 190	34	38	50	24993	357	221	163	22	M12x35	123,3	3,85
150 x 200	34	38	50	29217	390	225	169	24	M12x35	123,3	4,07
160 x 210	34	38	50	33756	422	229	174	26	M12x35	123,3	4,30
170 x 225	38	44	58	39483	465	212	160	22	M14x40	187	5,80
180 x 235	38	44	58	45606	507	218	167	24	M14x40	187	6,00
190 x 250	46	52	66	56163	591	199	152	28	M14x45	187	8,50
200 x 260	46	52	66	63342	633	203	156	30	M14x45	187	8,60
220 x 285	50	56	72	81960	745	200	154	26	M16x50	290	11,00
240 x 305	50	56	72	103162	860	211	166	30	M16x50	290	12,00
260 x 325	50	56	72	126669	974	221	177	34	M16x50	290	13,00
280 x 355	60	66	84	157339	1124	197	156	32	M18x60	400	19,00
300 x 375	60	66	84	189653	1264	207	166	36	M18x60	400	20,00
320 x 405	72	78	98	264108	1651	211	167	36	M20x70	580	30,00

Spannsätze – Nicht selbstzentrierend „BK 50“ Locking Assemblies – Not self-centering „BK 50“

- Für sehr hohe Drehmomente geeignet
suitable for very high torques
- Toleranzen tolerances:
Bis Durchmesser 40 = Welle h6 - Nabe H7
up to diameter 40 = shaft h6 - hub H7
Über Durchmesser 40 = Welle h8 - Nabe H8
over diameter 40 = shaft h8 - hub H8
- Oberflächenrauigkeit: Rt max 16 µm
surface roughness: Rt max 16 µm

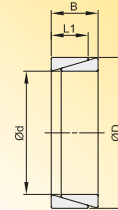
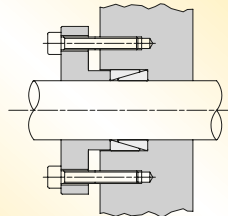

Abmessung dimension			Übertragbares Drehmoment transferable torque	Axialkraft axial force	Flächenpressung zwischen pressure between		Gewicht weight
d x D mm	L1 mm	B mm			Spannsatz und locking assembly and		
			Mt Nm	F ax. KN	Welle shaft pw N/mm ²	Nabe hub pn N/mm ²	kg
12 x 15	3,7	4,5	10	2	98	78	0,01
14 x 18	5,3	6,3	19	3	98	76	0,01
15 x 19	5,3	6,3	22	3	98	77	0,01
16 x 20	5,3	6,3	25	3	98	78	0,01
17 x 21	5,3	6,3	28	3	98	79	0,01
18 x 22	5,3	6,3	32	4	98	80	0,01
19 x 24	5,3	6,3	35	4	98	77	0,01
20 x 25	5,3	6,3	39	4	98	78	0,01
22 x 26	5,3	6,3	47	4	98	83	0,01
24 x 28	5,3	6,3	57	5	98	84	0,01
25 x 30	5,3	6,3	61	5	98	81	0,01
28 x 32	5,3	6,3	76	5	98	86	0,01
30 x 35	5,3	6,3	88	6	98	84	0,01
32 x 36	5,3	6,3	100	6	98	87	0,02
35 x 40	6,0	7,0	136	8	98	86	0,02
36 x 42	6,0	7,0	144	8	98	84	0,02
38 x 44	6,0	7,0	160	8	98	84	0,02
40 x 45	6,6	8,0	195	10	98	87	0,03
42 x 48	6,6	8,0	216	10	98	86	0,04
45 x 52	8,6	10,0	321	14	98	85	0,04
48 x 55	8,6	10,0	367	15	98	85	0,05
50 x 57	8,6	10,0	397	16	98	86	0,05
55 x 62	8,6	10,0	480	17	98	87	0,06
56 x 64	10,4	12,0	603	22	98	86	0,07
60 x 68	10,4	12,0	692	23	98	86	0,07
63 x 71	10,4	12,0	764	24	98	87	0,08
65 x 73	10,4	12,0	813	25	98	87	0,08
70 x 79	12,2	14,0	1110	32	98	87	0,11
71 x 80	12,2	14,0	1140	32	98	87	0,12
75 x 84	12,2	14,0	1260	34	98	87	0,12
80 x 91	15,0	17,0	1770	44	98	86	0,20
90 x 101	15,0	17,0	2240	50	98	87	0,22
100 x 114	18,7	21,0	3450	70	98	86	0,38

Spannsätze – Selbstzentrierend „BK 61“ Locking Assemblies – Self-centering „BK 61“

- Für sehr hohe Drehmomente geeignet
suitable for very high torques
- Toleranzen: Welle h8 - Nabe H8
tolerances: shaft h8 – hub H8
- Oberflächenrauigkeit: R_t max 16 μ m
surface roughness: R_t max 16 μ m
- Rundlauffehler: 0,02 mm \div 0,04 mm
concentricity error: 0,02 mm \div 0,04 mm
- Kurze Einbauzeit
short installation time
- Geringfügige axiale Verschiebung bei der Montage möglich
slight axial displacement during assembly possible

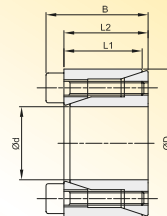
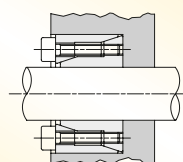

Abmessung dimension				Übertragbares Drehmoment transferable torque	Axialkraft axial force	Flächenpressung zwischen pressure between		Spannschrauben tensioning screws			Gewicht weight
d x D mm	L1 mm	L2 mm	B mm			Mt Nm	F ax. KN	Spannsatz und locking assembly and Welle shaft	Nabe hub	DIN 912 12,9	
						pw N/mm ²	pn N/mm ²	Anzahl quantity	Typ	Ms Nm	kg
10 x 20	12,5	13	15,5	19	3,8	89	45	4	M2,5x12	1,2	0,02
11 x 22	12,5	13	15,5	21	3,8	81	41	4	M2,5x12	1,2	0,02
12 x 22	12,5	13	15,5	23	3,8	75	41	4	M2,5x12	1,2	0,02
14 x 26	16,5	17	20	39	5,5	71	38	4	M3x16	2,1	0,04
15 x 28	16,5	17	20	42	5,5	66	35	4	M3x16	2,1	0,04
16 x 32	16,5	17	21	77	9,6	107	54	4	M4x16	4,9	0,07
17 x 35	20,5	21	25	82	9,6	81	40	4	M4x20	4,9	0,09
18 x 35	20,5	21	25	87	9,6	77	40	4	M4x20	4,9	0,09
19 x 35	20,5	21	25	91	9,6	73	40	4	M4x20	4,9	0,08
20 x 38	20,5	21	26	157	15,7	113	60	4	M5x20	10	0,10
22 x 40	20,5	21	26	173	15,7	103	57	4	M5x20	10	0,11
24 x 47	25	26	32	268	22,3	110	56	4	M6x24	17	0,20
25 x 47	25	26	32	279	22,3	105	56	4	M6x24	17	0,19
28 x 50	25	26	32	468	33,5	141	79	6	M6x24	17	0,22
30 x 55	25	26	32	502	33,5	132	72	6	M6x24	17	0,27
32 x 55	25	26	32	535	33,5	123	72	6	M6x24	17	0,25
35 x 60	30	31	37	781	44,6	125	73	8	M6x28	17	0,36
38 x 65	30	31	37	848	44,6	115	67	8	M6x28	17	0,43
40 x 65	30	31	37	892	44,6	110	67	8	M6x28	17	0,40
42 x 75	35	36	44	1272	60,6	122	68	6	M8x34	41	0,67
45 x 75	35	36	44	1363	60,6	113	68	6	M8x34	41	0,63
48 x 80	35	36	44	1938	80,8	142	85	8	M8x34	41	0,74
50 x 80	35	36	44	2019	80,8	136	85	8	M8x34	41	0,70

Spannsätze – Selbstzentrierend „BK 70“ Locking Assemblies – Self-centering „BK 70“

- Für sehr hohe Drehmomente geeignet
suitable for very high torques
- Toleranzen: Welle h8 - Nabe H8
tolerances: shaft h8 – hub H8
- Oberflächenrauigkeit: R_t max 16 μ m
surface roughness: R_t max 16 μ m
- Rundlauffehler: 0,02 mm \div 0,04 mm
concentricity error: 0,02 mm \div 0,04 mm
- Kurze Einbauzeit
short installation time
- Geringfügige axiale Verschiebung bei der Montage möglich
slight axial displacement during assembly possible

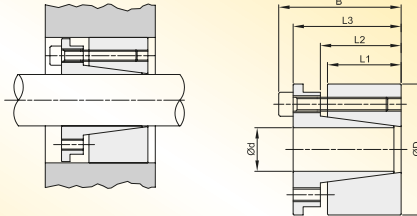

Abmessung dimension					Übertragbares Drehmoment transferable torque	Axialkraft axial force	Flächenpressung zwischen pressure between		Spannschrauben tensioning screws		Gewicht weight	
							Welle shaft	Nabe hub	DIN 912 12,9	Anzugs- moment tightening torque		
d x D mm	L1 mm	L2 mm	L3 mm	B mm	Mt Nm	F ax. KN	pw N/mm ²	pn N/mm ²	Anzahl quantity	Typ	Ms Nm	kg
19 x 47	26	31	39	45	307	32	193	78	4	M6x25	17	0,39
20 x 47	26	31	39	45	323	32	183	78	4	M6x25	17	0,38
22 x 47	26	31	39	45	355	32	166	78	4	M6x25	17	0,37
24 x 50	26	31	39	45	582	48	229	110	6	M6x25	17	0,43
25 x 50	26	31	39	45	606	48	220	110	6	M6x25	17	0,42
28 x 55	26	31	39	45	679	48	196	100	6	M6x25	17	0,55
30 x 55	26	31	39	45	727	48	183	100	6	M6x25	17	0,56
32 x 60	26	31	39	45	1033	65	229	122	8	M6x25	17	0,60
35 x 60	26	31	39	45	1130	65	209	122	8	M6x25	17	0,50
38 x 65	26	31	39	45	1227	65	193	113	8	M6x25	17	0,60
40 x 65	26	31	39	45	1292	65	183	113	8	M6x25	17	0,60
42 x 75	30	36	47	55	1835	87	204	115	6	M8x30	41	1,00
45 x 75	30	36	47	55	1966	87	191	115	6	M8x30	41	1,00
48 x 80	30	36	47	55	2097	87	179	107	6	M8x30	41	1,10
50 x 80	30	36	47	55	2184	87	172	107	6	M8x30	41	1,00
55 x 85	30	36	47	55	3202	116	208	135	8	M8x30	41	1,10
60 x 90	30	36	47	55	3493	116	191	127	8	M8x30	41	1,20
65 x 95	30	36	47	55	3784	116	176	120	8	M8x30	41	1,30
70 x 110	40	46	57	67	6607	189	199	127	8	M10x35	83	2,20
75 x 115	40	46	62	72	7079	189	186	121	8	M10x35	83	2,50
80 x 120	40	46	62	72	7551	189	174	116	8	M10x35	83	2,60
85 x 125	40	46	62	72	10029	236	205	139	10	M10x35	83	2,80
90 x 130	40	46	62	72	10619	236	193	134	10	M10x35	83	2,70
95 x 135	40	46	62	72	11209	236	183	129	10	M10x35	83	2,90
100 x 145	46	52	77	89	13738	275	176	121	8	M12x45	145	3,90
110 x 155	46	52	77	89	15111	275	160	114	8	M12x45	145	4,20
120 x 165	46	52	77	89	20606	343	183	133	10	M12x45	145	4,80
130 x 180	46	52	77	89	26788	412	203	147	12	M12x45	145	5,00
140 x 190	51	59	84	98	26142	373	154	114	8	M14x45	230	6,50
150 x 200	51	59	84	98	35016	467	180	135	10	M14x45	230	7,00
160 x 210	51	59	84	98	37351	467	169	129	10	M14x45	230	7,00
170 x 225	51	59	84	98	47617	560	191	144	12	M14x45	230	8,50
180 x 235	51	59	84	98	50418	560	180	138	12	M14x45	230	9,00

Spannsätze – Selbstzentrierend „BK 71“ Locking Assemblies – Self-centering „BK 71“

- Für sehr hohe Drehmomente geeignet
suitable for very high torques
- Toleranzen: Welle h8 - Nabe H8
tolerances: shaft h8 – hub H8
- Oberflächenrauigkeit: R_t max 16 μm
surface roughness: R_t max 16 μm
- Rundlauffehler: 0,02 mm \div 0,04 mm
concentricity error: 0,02 mm \div 0,04 mm
- Kurze Einbauzeit
short installation time

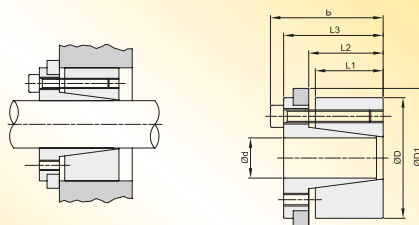

Abmessung dimension						Übertragbares Drehmoment transferable torque	Axialkraft axial force	Flächenpressung zwischen pressure between		Spannschrauben tensioning screws			Gewicht weight
								Spannsatz und locking assembly and		DIN 912 12,9	Anzugs- moment tightening torque		
d x D mm	L1 mm	L2 mm	L3 mm	B mm	D1 mm	Mt Nm	F ax. KN	pw N/mm ²	pn N/mm ²	Anzahl quantity	Typ	Ms Nm	kg
19 x 47	26	31	39	45	53	202	21	127	51	4	M6x20	17	0,45
20 x 47	26	31	39	45	53	213	21	121	51	4	M6x20	17	0,46
22 x 47	26	31	39	45	53	234	21	110	51	4	M6x20	17	0,50
24 x 50	26	31	39	45	56	384	32	151	73	6	M6x20	17	0,50
25 x 50	26	31	39	45	56	400	32	145	73	6	M6x20	17	0,50
28 x 55	26	31	39	45	61	448	32	129	66	6	M6x20	17	0,60
30 x 55	26	31	39	45	61	480	32	121	66	6	M6x20	17	0,60
32 x 60	26	31	39	45	66	683	43	151	81	8	M6x20	17	0,70
35 x 60	26	31	39	45	66	747	43	138	81	8	M6x20	17	0,60
38 x 65	26	31	39	45	71	811	43	127	74	8	M6x20	17	0,80
40 x 65	26	31	39	45	71	853	43	121	74	8	M6x20	17	0,60
42 x 75	30	36	47	55	81	1216	58	135	76	6	M8x30	41	1,20
45 x 75	30	36	47	55	81	1302	58	126	76	6	M8x30	41	1,10
48 x 80	30	36	47	55	86	1389	58	119	71	6	M8x30	41	1,30
50 x 80	30	36	47	55	86	1447	58	114	71	6	M8x30	41	1,10
55 x 85	30	36	47	55	91	2124	77	138	89	8	M8x30	41	1,20
60 x 90	30	36	47	55	96	2317	77	127	84	8	M8x30	41	1,30
65 x 95	30	36	47	55	101	2510	77	117	80	8	M8x30	41	1,40
70 x 110	40	46	57	67	116	4381	125	132	84	8	M10x35	83	2,50
75 x 115	40	46	62	72	121	4694	125	123	80	8	M10x35	83	2,60
80 x 120	40	46	62	72	126	5007	125	115	77	8	M10x35	83	2,80
85 x 125	40	46	62	72	131	6651	156	136	92	10	M10x35	83	2,80
90 x 130	40	46	62	72	136	7042	156	128	89	10	M10x35	83	3,00
95 x 135	40	46	62	72	141	7433	156	121	85	10	M10x35	83	3,00
100 x 145	46	52	77	89	151	9104	182	117	81	8	M12x45	145	5,50
110 x 155	46	52	77	89	161	10015	182	106	75	8	M12x45	145	4,80
120 x 165	46	52	77	89	171	13653	228	122	88	10	M12x45	145	5,50
130 x 180	46	52	77	89	186	17747	273	135	97	12	M12x45	145	6,00
140 x 190	51	59	84	98	196	17328	248	102	75	8	M14x45	230	7,50
150 x 200	51	59	84	98	206	23207	309	119	89	10	M14x45	230	7,70
160 x 210	51	59	84	98	216	24754	309	112	85	10	M14x45	230	8,00
170 x 225	51	59	84	98	231	31561	371	126	95	12	M14x45	230	9,80
180 x 235	51	59	84	98	241	33417	371	119	91	12	M14x45	230	9,80

Spannsätze – Selbstzentrierend „BK 80“ Locking Assemblies – Self-centering „BK 80“

- Für sehr hohe Drehmomente geeignet
suitable for very high torques
- Toleranzen: Welle h8 - Nabe H8
tolerances: shaft h8 – hub H8
- Oberflächenrauigkeit: R_t max 16 μ m
surface roughness: R_t max 16 μ m
- Rundlauffehler: 0,02 mm \div 0,04 mm
concentricity error: 0,02 mm \div 0,04 mm
- Kurze Einbauzeit *short installation time*

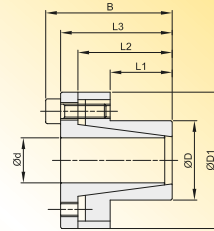
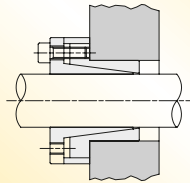

Abmessung dimension							Übertragbares Drehmoment transferable torque	Axialkraft axial force	Spannsatz und locking assembly and		Spannschrauben tensioning screws		Gewicht weight	
d x D mm	L1 mm	L2 mm	L3 mm	B mm	D1 mm	D2 mm			Welle shaft	Nabe hub	DIN 912 12,9	Anzugs- moment tightening torque		
						Mt Nm	F ax. KN	pw N/mm ²	pn N/mm ²	Anzahl quantity	Typ	Ms Nm	kg	
8 x 15	12	21	24	28	28	32	39	10	299	159	4	M4x10	5,2	0,16
9 x 16	14	23	27	31	28	32	44	10	227	128	4	M4x12	5,2	0,16
10 x 16	14	23	27	31	28	32	49	10	205	128	4	M4x12	5,2	0,17
11 x 18	14	23	27	31	30	34	53	10	186	114	4	M4x12	5,2	0,17
12 x 18	14	23	27	31	30	34	58	10	171	114	4	M4x12	5,2	0,18
14 x 23	14	23	27	31	35	39	68	10	146	89	4	M4x12	5,2	0,20
15 x 24	16	29	36	42	40	45	120	16	196	123	4	M6x18	17	0,21
16 x 24	16	29	36	42	40	45	128	16	184	123	4	M6x18	17	0,23
18 x 26	18	31	38	44	42	47	191	21	194	134	4	M6x18	17	0,27
19 x 27	18	31	38	44	43	48	202	21	183	129	4	M6x18	17	0,29
20 x 28	18	31	38	44	44	49	213	21	174	124	4	M6x18	17	0,30
22 x 32	25	38	45	51	48	54	234	21	114	78	4	M6x18	17	0,38
24 x 34	25	38	45	51	50	56	255	21	105	74	4	M6x18	17	0,41
25 x 34	25	38	45	51	50	56	266	21	100	74	4	M6x18	17	0,45
28 x 39	25	38	45	51	55	61	373	27	112	81	5	M6x18	17	0,47
30 x 41	25	38	45	51	57	63	480	32	126	92	6	M6x18	17	0,48
32 x 43	30	43	50	56	59	65	511	32	98	73	6	M6x18	17	0,51
35 x 47	30	43	50	56	63	69	747	43	120	89	8	M6x18	17	0,63
38 x 50	30	43	50	56	66	72	811	43	110	84	8	M6x18	17	0,67
40 x 53	32	45	52	58	69	75	959	48	110	83	9	M6x18	17	0,73
42 x 55	32	45	52	58	71	77	1007	48	105	80	9	M6x18	17	0,78
45 x 59	40	56	64	72	79	85	1781	79	130	99	8	M8x22	42	1,23
48 x 62	40	56	64	72	82	88	1900	79	122	94	8	M8x22	42	1,24
50 x 65	50	66	74	82	85	92	2473	99	117	90	10	M8x22	42	1,40
55 x 71	50	66	74	82	91	98	2721	99	106	82	10	M8x22	42	1,70
60 x 77	50	66	74	82	97	104	2968	99	97	76	10	M8x22	42	1,76
65 x 84	50	66	74	82	104	111	3215	99	90	69	10	M8x22	42	2,21
70 x 90	60	80	91	101	115	122	4430	127	89	69	8	M10x25	84	3,05
75 x 95	60	80	91	101	119	126	5338	142	93	74	9	M10x25	84	3,32
80 x 100	65	85	96	106	124	131	7595	190	108	86	12	M10x25	84	3,50
85 x 106	65	85	96	106	130	137	8069	190	101	81	12	M10x25	84	3,60
90 x 112	65	85	96	106	136	143	9968	222	112	90	14	M10x25	84	3,90
95 x 120	65	85	96	106	144	153	10522	222	106	84	14	M10x25	84	4,40
100 x 125	65	89	102	114	153	162	13651	273	124	99	12	M12x30	145	4,60
110 x 140	70	94	107	119	168	177	15016	273	105	82	12	M12x30	145	8,70
120 x 155	90	114	127	139	185	195	21844	364	99	77	16	M12x30	145	10,70
130 x 165	90	114	127	139	195	205	23664	364	92	72	16	M12x30	145	11,30
140 x 175	90	114	127	139	205	215	25485	364	85	68	16	M12x30	145	11,90
150 x 185	90	114	127	139	215	225	27305	364	80	64	16	M12x30	145	12,50

Spannsätze – Starre Kupplung „BK 95“ Locking Assemblies - Rigid coupling „BK 95“

- Für sehr hohe Drehmomente geeignet
suitable for very high torques
- Toleranzen: Welle h8
tolerances: shaft h8
- Oberflächenrauigkeit: R_t max 16 μm
surface roughness: R_t max 16 μm
- Schnelle Montage und Demontage
fast installation and disassembling
- Geeignet für starre Verbindung
zwischen zwei fluchtenden Wellen
*suitable for rigid connection between
two aligned shafts*

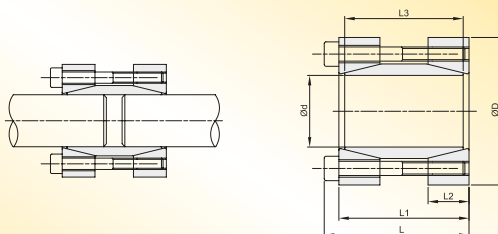

							Flächenpressung zwischen pressure between	Spannschrauben tensioning screws			
Abmessung dimension					Übertragbares Drehmoment transferable torque	Axialkraft axial force	Welle shaft	DIN 912 12,9	Anzugs- moment tightening torque	Gewicht weight	
d x D mm	L mm	L1 mm	L2 mm	L3 mm	Mt Nm	F ax. KN	pw N/mm ²	Anzahl quantity	Typ	Ms Nm	kg
17 x 50	56	50	16	44	179	21	166	4	M6x45	17	0,51
18 x 50	56	50	16	44	190	21	157	4	M6x45	17	0,52
19 x 50	56	50	16	44	200	21	149	4	M6x45	17	0,50
20 x 50	56	50	16	44	211	21	141	4	M6x45	17	0,50
24 x 55	66	60	18,5	54	378	32	144	6	M6x55	17	0,71
25 x 55	66	60	18,5	54	394	32	138	6	M6x55	17	0,69
28 x 60	66	60	18,5	54	442	32	123	6	M6x55	17	0,81
30 x 60	66	60	18,5	54	473	32	115	6	M6x55	17	0,78
32 x 63	66	60	18,5	54	505	32	108	6	M6x55	17	0,85
35 x 75	83	75	22	67	682	39	98	4	M8x70	42	1,48
38 x 75	83	75	22	67	741	39	90	4	M8x70	42	1,45
40 x 75	83	75	22	67	780	39	86	4	M8x70	42	1,40
42 x 78	83	75	22	67	819	39	82	4	M8x70	42	1,50
45 x 85	93	85	24,5	76	1317	59	101	6	M8x80	42	2,03
48 x 90	93	85	24,5	76	1405	59	95	6	M8x80	42	2,24
50 x 90	93	85	24,5	76	1463	59	91	6	M8x80	42	2,18
55 x 94	93	85	24,5	76	2147	78	110	8	M8x80	42	2,29
60 x 100	93	85	24,5	76	2343	78	101	8	M8x80	42	2,52
65 x 105	93	85	24,5	76	2538	78	93	8	M8x80	42	2,69
70 x 115	110	100	29	90	4321	123	116	8	M10x95	83	3,94

Klemmplatten für Zahnriemen Clamping plates for Timing Belts

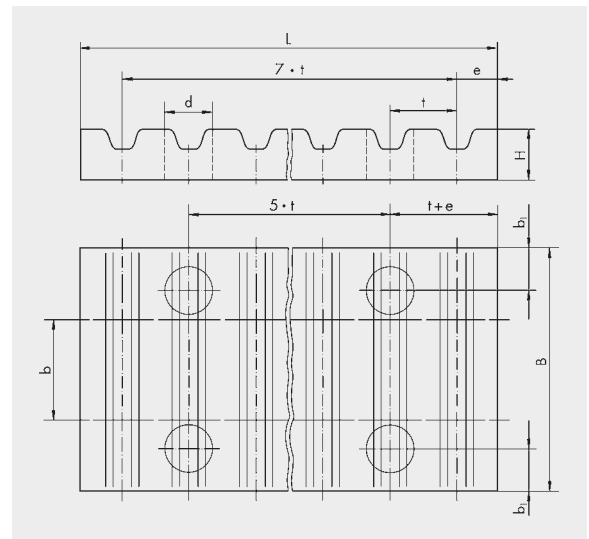

Artikel- Bezeichnung Designation	Teilung Pitch t (mm)	Riemenbreite Belt width b (mm)	Material	B (mm)	a (mm)	L (mm)	e (mm)	H (mm)	d (mm)	Gewicht Weight ≈ (kg)	€ Stück each
CP-XL 025	5,080	6,35	Al	25,5	6,0	42,5	3,5	8,0	5,5	0,020	auf Anfrage on request
CP-XL 037	5,080	9,53	Al	28,5	6,0	42,5	3,5	8,0	5,5	0,025	
CP-XL 050	5,080	12,70	Al	32,0	6,0	42,5	3,5	8,0	5,5	0,027	
CP-XL 075	5,080	19,05	Al	38,0	6,0	42,5	3,5	8,0	5,5	0,032	
CP-XL 100	5,080	25,40	Al	45,0	6,0	42,5	3,5	8,0	5,5	0,038	
CP-L 037	9,525	9,53	Al	36,0	8,0	76,6	5,0	15,0	9,0	0,095	
CP-L 050	9,525	12,70	Al	39,0	8,0	76,6	5,0	15,0	9,0	0,104	
CP-L 075	9,525	19,05	Al	45,0	8,0	76,6	5,0	15,0	9,0	0,121	
CP-L 100	9,525	25,40	Al	51,5	8,0	76,6	5,0	15,0	9,0	0,140	
CP-L 150	9,525	38,10	Al	64,0	8,0	76,6	5,0	15,0	9,0	0,177	
CP-L 200	9,525	50,80	Al	77,0	8,0	76,6	5,0	15,0	9,0	0,215	
CP-H 050	12,700	12,70	Al	45,0	10,0	106,9	9,0	22,0	11,0	0,050	
CP-H 075	12,700	19,05	Al	51,0	10,0	106,9	9,0	22,0	11,0	0,075	
CP-H 100	12,700	25,40	Al	57,5	10,0	106,9	9,0	22,0	11,0	0,100	
CP-H 150	12,700	38,10	Al	70,0	10,0	106,9	9,0	22,0	11,0	0,150	
CP-H 200	12,700	50,80	Al	83,0	10,0	106,9	9,0	22,0	11,0	0,200	
CP-H 300	12,700	76,20	Al	108,0	10,0	106,9	9,0	22,0	11,0	0,300	
CP-H 400	12,700	101,60	Al	134,0	10,0	106,9	9,0	22,0	11,0	0,400	
CP-5M 06	5,000	6,00	Al	25,0	6,0	41,8	3,2	8,0	5,5	0,015	
CP-5M 09	5,000	9,00	Al	28,0	6,0	41,8	3,2	8,0	5,5	0,018	
CP-5M 15	5,000	15,00	Al	34,0	6,0	41,8	3,2	8,0	5,5	0,022	
CP-5M 25	5,000	25,00	Al	44,0	6,0	41,8	3,2	8,0	5,5	0,030	
CP-8M 10	8,000	10,00	Al	35,0	8,0	66,0	5,0	15,0	9,0	0,075	
CP-8M 15	8,000	15,00	Al	40,0	8,0	66,0	5,0	15,0	9,0	0,085	
CP-8M 20	8,000	20,00	Al	45,0	8,0	66,0	5,0	15,0	9,0	0,100	
CP-8M 30	8,000	30,00	Al	55,0	8,0	66,0	5,0	15,0	9,0	0,120	
CP-8M 50	8,000	50,00	Al	75,0	8,0	66,0	5,0	15,0	9,0	0,170	
CP-8M 85	8,000	85,00	Al	110,0	8,0	66,0	5,0	15,0	9,0	0,250	
CP-14M 25	14,000	25,00	Al	56,0	10,0	116,0	9,0	22,0	11,0	0,315	
CP-14M 40	14,000	40,00	Al	71,0	10,0	116,0	9,0	22,0	11,0	0,405	
CP-14M 55	14,000	55,00	Al	86,0	10,0	116,0	9,0	22,0	11,0	0,495	
CP-14M 85	14,000	85,00	Al	116,0	10,0	116,0	9,0	22,0	11,0	0,860	
CP-14M 115	14,000	115,00	Al	146,0	10,0	116,0	9,0	22,0	11,0	1,195	

Klemmplatten für Polyurethan-Zahnriemen

Clamping plates for Polyurethane-Timing Belts

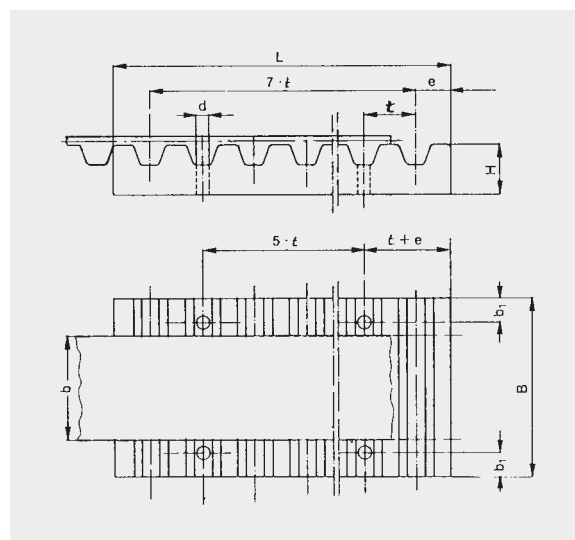

Artikel- Bezeichnung Designation	Teilung Pitch t (mm)	Riemenbreite Belt width b (mm)	Material	B (mm)	a (mm)	L (mm)	e (mm)	H (mm)	d (mm)	Gewicht Weight ≈ (kg)	€ Stück each
CP- 6 T5	5,000	6,00	Al	25,0	6,0	41,8	3,2	8,0	5,5	0,020	auf Anfrage on request
CP- 10 T5	5,000	10,00	Al	29,0	6,0	41,8	3,2	8,0	5,5	0,025	
CP- 16 T5	5,000	16,00	Al	35,0	6,0	41,8	3,2	8,0	5,5	0,030	
CP- 25 T5	5,000	25,00	Al	44,0	6,0	41,8	3,2	8,0	5,5	0,036	
CP- 32 T5	5,000	32,00	Al	51,0	6,0	41,8	3,2	8,0	5,5	0,042	
CP- 50 T5	5,000	50,00	Al	69,0	6,0	41,8	3,2	8,0	5,5	0,051	
CP- 16 T10	10,000	16,00	Al	41,0	8,0	80,0	5,0	15,0	9,0	0,115	
CP- 25 T10	10,000	25,00	Al	50,0	8,0	80,0	5,0	15,0	9,0	0,140	
CP- 32 T10	10,000	32,00	Al	57,0	8,0	80,0	5,0	15,0	9,0	0,160	
CP- 50 T10	10,000	50,00	Al	75,0	8,0	80,0	5,0	15,0	9,0	0,215	
CP- 75 T10	10,000	75,00	Al	100,0	8,0	80,0	5,0	15,0	9,0	0,290	
CP-100 T10	10,000	100,00	Al	125,0	8,0	80,0	5,0	15,0	9,0	0,370	
CP- 25 T20	20,000	25,00	Al	56,0	10,0	160,0	10,0	20,0	11,0	0,385	
CP- 32 T20	20,000	32,00	Al	65,0	10,0	160,0	10,0	20,0	11,0	0,450	
CP- 50 T20	20,000	50,00	Al	81,0	10,0	160,0	10,0	20,0	11,0	0,570	
CP- 75 T20	20,000	75,00	Al	106,0	10,0	160,0	10,0	20,0	11,0	0,755	
CP-100 T20	20,000	100,00	Al	132,0	10,0	160,0	10,0	20,0	11,0	0,940	
CP- 6 AT5	5,000	6,00	Al	25,0	6,0	41,8	3,2	8,0	5,5	0,016	
CP- 10 AT5	5,000	10,00	Al	29,0	6,0	41,8	3,2	8,0	5,5	0,019	
CP- 16 AT5	5,000	16,00	Al	35,0	6,0	41,8	3,2	8,0	5,5	0,024	
CP- 25 AT5	5,000	25,00	Al	44,0	6,0	41,8	3,2	8,0	5,5	0,031	
CP- 32 AT5	5,000	32,00	Al	51,0	6,0	41,8	3,2	8,0	5,5	0,036	
CP- 50 AT5	5,000	50,00	Al	61,0	6,0	41,8	3,2	8,0	5,5	0,043	
CP- 16 AT10	10,000	16,00	Al	41,0	8,0	80,0	5,0	15,0	9,0	0,110	
CP- 25 AT10	10,000	25,00	Al	50,0	8,0	80,0	5,0	15,0	9,0	0,135	
CP- 32 AT10	10,000	32,00	Al	57,0	8,0	80,0	5,0	15,0	9,0	0,155	
CP- 50 AT10	10,000	50,00	Al	75,0	8,0	80,0	5,0	15,0	9,0	0,205	
CP- 75 AT10	10,000	75,00	Al	100,0	8,0	80,0	5,0	15,0	9,0	0,280	
CP-100 AT10	10,000	100,00	Al	125,0	8,0	80,0	5,0	15,0	9,0	0,350	
CP- 25 AT20	20,000	25,00	Al	56,0	10,0	160,0	10,0	20,0	11,0	0,385	
CP- 32 AT20	20,000	32,00	Al	65,0	10,0	160,0	10,0	20,0	11,0	0,450	
CP- 50 AT20	20,000	50,00	Al	81,0	10,0	160,0	10,0	20,0	11,0	0,570	
CP- 75 AT20	20,000	75,00	Al	106,0	10,0	160,0	10,0	20,0	11,0	0,755	
CP-100 AT20	20,000	100,00	Al	132,0	10,0	160,0	10,0	20,0	11,0	0,940	

Weitere Abmessungen auf Anfrage. Further sizes on request.
Al = Aluminium

Die Preise dieser Liste stellen keine Preisempfehlung für den Weiterverkauf dar. **Versandkosten zu Lasten des Empfängers.**
Bezüglich der Haftung und Lieferung verweisen wir auf unsere allgemeinen Geschäftsbedingungen.
Mit Erscheinen dieser Liste verlieren alle früheren Preislisten ihre Gültigkeit, dies gilt auch für vorhergehende Auflagen.
Änderungen auf Grund technischer Neuerungen sowie Irrtum vorbehalten.
Nachdruck, auch auszugsweise, verboten. Zuwiderhandlungen werden urheberrechtlich verfolgt.

*The prices in this list are not for resale use. **Freight charges are the responsibility of the customer.**
Refer to our "General Conditions of Sale" for matters concerning liability and delivery.
With the introduction of this list all other price lists are superceded.
Alterations due to error or to technical improvements are excepted.
Reproduction, even in extracts, is strictly forbidden. Violations of copyright will be prosecuted.*

Autorisierter Händler | Distributeur autorisé | Distributore autorizzato | Authorized distributor



H. FRÖHLICH AG | INDUSTRIE TECHNIK

Widenholzstrasse 1
CH-8304 Wallisellen
Tel. +41 44 527 20 00
Fax +41 44 527 20 19
info@hfag.ch | www.hfag.ch

Strongbelt

Antriebstechnik



PTS Power Transmission Strongbelt GmbH
Postfach 2945 • 33259 Gütersloh • Germany
Friedrichsdorfer Str. 111 • 33335 Gütersloh
Germany
Telefon +49 (0)52 41-74 080
Fax +49 (0)52 41-74 0888
info@strongbelt.com • www.strongbelt.com